

# DX-D 100

5410/050

5411/050

5411/300

5411/400

---

## User Manual



# Contents

<b>Legal Notice.....</b>	<b>4</b>
<b>Introduction to this Manual.....</b>	<b>5</b>
Scope.....	6
About the safety notices in this document.....	7
Disclaimer.....	8
<b>Introduction.....</b>	<b>9</b>
Intended Use.....	10
Intended User.....	11
Configuration.....	12
DX-D 100.....	13
Integration.....	15
Options and Accessories.....	16
Operation Controls.....	17
The Control Console.....	19
The Control Panel.....	21
Infrared remote control.....	22
Portable DR detector.....	23
Storage bin.....	24
System Documentation.....	25
The DX-D 100 User Documentation contains:.....	26
The Getting Started material contains:.....	26
Product Complaints.....	27
Classification.....	28
Compliance.....	29
For USA.....	29
Connectivity.....	30
Connecting DX-D 100 to a wired network.....	31
Connecting USB devices.....	32
Installation.....	33
Storage of Allen wrench.....	33
Labels.....	34
Messages.....	35
Cleaning and Disinfecting.....	36
Cleaning.....	37
Disinfecting.....	38
Approved disinfectants.....	39
Patient data security.....	40
RFID key lost or stolen.....	40
Maintenance.....	41
Safety Directions.....	42
Cleaning the system.....	44
Disinfection of the system.....	44
Emergency stop button.....	45
Environmental protection.....	46

<b>Getting started</b> .....	<b>47</b>
Starting DX-D 100.....	48
Operating DX-D 100.....	50
Displacement and positioning workflow.....	51
Basic imaging workflow.....	53
Using the ‘virtual keyboard’.....	56
Barcode reader.....	57
Charging a DR Detector battery.....	58
Charging a DR detector in the storage bin.....	59
Managing the access codes for the on/off keypad.....	60
Managing the RFID reader for user authentication.....	61
Stopping DX-D 100.....	64
Stopping the MUSICA Acquisition Workstation by logging out of Windows.....	65
<b>Problem solving</b> .....	<b>66</b>
Corner area of detector not exposed.....	67
Motorized movement has stopped and unit cannot be moved.....	68
<b>Technical Data</b> .....	<b>69</b>
DX-D 100 Technical Data.....	69
DR Detector Technical Data.....	70
Mobile X-Ray Unit Technical Data.....	70

## Legal Notice

---



 Agfa NV, Septestraat 27, 2640 Mortsel - Belgium

For more information on Agfa products, please visit [agfaradiologysolutions.com](http://agfaradiologysolutions.com).

Agfa and the Agfa rhombus are trademarks of Agfa-Gevaert N.V., Belgium or its affiliates. NX and DX-D 100 are trademarks of Agfa NV, Belgium or one of its affiliates. All other trademarks are held by their respective owners and are used in an editorial fashion with no intention of infringement.

Agfa NV makes no warranties or representation, expressed or implied, with respect to the accuracy, completeness or usefulness of the information contained in this document and specifically disclaims warranties of suitability for any particular purpose. Products and services may not be available for your local area. Please contact your local sales representative for availability information. Agfa NV diligently strives to provide as accurate information as possible, but shall not be responsible for any typographical error. Agfa NV shall under no circumstances be liable for any damage arising from the use or inability to use any information, apparatus, method or process disclosed in this document. Agfa NV reserves the right to make changes to this document without prior notice. The original version of this document is in English.

Copyright 2025 Agfa NV

All rights reserved.

Published by Agfa NV

2640 Mortsel - Belgium.

No part of this document may be reproduced, copied, adapted or transmitted in any form or by any means without the written permission of Agfa NV

# Introduction to this Manual

---

- [Scope](#) on page 6
- [About the safety notices in this document](#) on page 7
- [Disclaimer](#) on page 8

## Scope

---

This User Manual describes the features of the DX-D 100 System, an integrated mobile Digital Radiography X-Ray System to be used as medical diagnostic aid in General Radiography and emergency departments. It explains how the different components of the DX-D 100 System work together.

## About the safety notices in this document

---

The following samples show how warnings, cautions, instructions and notes appear in this document. The text explains their intended use.



**DANGER:** A danger safety notice indicates a hazardous situation of direct, immediate danger for a potential serious injury to a user, service engineer, patient or any other person.



**Warning:** A warning safety notice indicates a hazardous situation which can lead to a potential serious injury to a user, service engineer, patient or any other person.



**Caution:** A caution safety notice indicates a hazardous situation which can lead to a potential minor injury to a user, service engineer, patient or any other person.



An instruction is a direction which, if it is not followed, can cause damage to the equipment described in this manual or any other equipment or goods and can cause environmental pollution.



A prohibition is a direction which, if it is not followed, can cause damage to the equipment described in this manual or any other equipment or goods and can cause environmental pollution.



**Note** Notes provide advice and highlight unusual points. A note is not intended as an instruction.

## Disclaimer

---

Agfa assumes no liability for use of this document if any unauthorized changes to the content or format have been made.

Every care has been taken to ensure the accuracy of the information in this document. However, Agfa assumes no responsibility or liability for errors, inaccuracies or omissions that may appear in this document. To improve reliability, function or design Agfa reserves the right to change the product without further notice. This manual is provided without warranty of any kind, implied or expressed, including, but not limited to, the implied warranties of merchantability and fitness for a particular purpose.



**Note** In the United States, Federal law restricts this device on order of a physician for prescription use only.

# Introduction

---

- [Intended Use](#) on page 10
- [Intended User](#) on page 11
- [Configuration](#) on page 12
- [Options and Accessories](#) on page 16
- [Operation Controls](#) on page 17
- [System Documentation](#) on page 25
- [Product Complaints](#) on page 27
- [Classification](#) on page 28
- [Compliance](#) on page 29
- [Connectivity](#) on page 30
- [Installation](#) on page 33
- [Labels](#) on page 34
- [Messages](#) on page 35
- [Cleaning and Disinfecting](#) on page 36
- [Patient data security](#) on page 40
- [Maintenance](#) on page 41
- [Safety Directions](#) on page 42
- [Environmental protection](#) on page 46

## Intended Use

---

- The DX-D 100 system is a mobile X-ray imaging system used in hospitals, clinics and medical practices by physicists, radiographers and radiologists to make, process and view static X-ray radiographic images of the skeleton (including skull, spinal column and extremities), chest, abdomen and other body parts on adult, pediatric or neonatal patients.
- Applications can be performed with the patient in the sitting, standing or lying position.
- This device is not intended for mammography applications.

## Intended User

---

This manual has been written for trained users of Agfa products and trained diagnostic X-Ray clinical personnel who have received proper training.

Users are those persons who actually handle the equipment and those who have authority over the equipment.

Before attempting to work with this equipment, the user must read, understand, note and strictly observe all warnings, cautions and safety markings on the equipment.

## Configuration

---

DX-D 100 is an integrated mobile Digital Radiography X-Ray System.

- [DX-D 100](#) on page 13
- [Integration](#) on page 15

## DX-D 100

DX-D 100 is a mobile **DR** X-Ray System (**D**irect **R**adiography **X**-Ray System).

The complete DX-D 100 consists of the following components:

- Mobile X-ray unit with integrated X-ray generator and NX software
- X-ray tube with manual collimator
- DR Detector

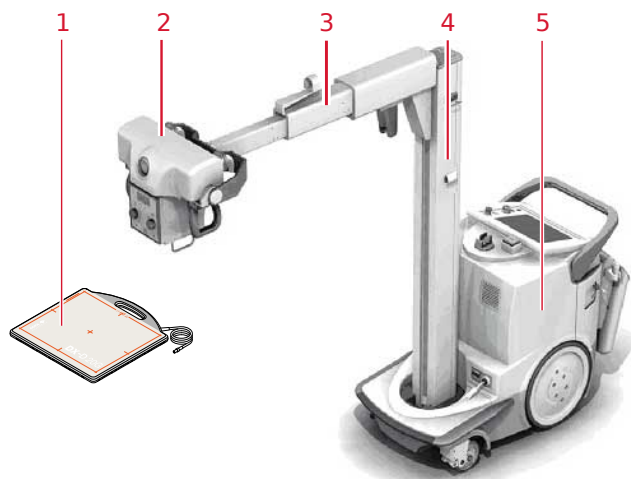

1. DR Detector
2. X-ray tube
3. Arm
4. Column
5. Mobile X-ray unit

### Figure 1: DX-D 100 configuration

DX-D 100 has four configurations:

- configuration with portable DR Detector, type number 5410/050
- configurations with wireless DR Detector, type numbers 5411/050, 5411/300 and 5411/400

The DX-D 100 configuration with wireless DR Detector has two variants of the vertical column:



**Figure 2: standard column**



**Figure 3: telescopic column**

## Integration

The integrated NX software controls all actions on the X-ray unit and induces the workflow. The integration between the NX software and the X-ray generator console is established by means of the X-ray device interface software.

## Options and Accessories

---

- Dose Area Product meter (DAP)
- Infrared remote control
- RFID reader for user authentication
- Barcode scanner for entering patient data
- Grids
- Allen Wrench

## Operation Controls

---

The two configurations of the DX-D 100 mostly have the same operation controls:

### Configuration with portable DR detector

The main operation controls of the DX-D 100 with portable DR detector:

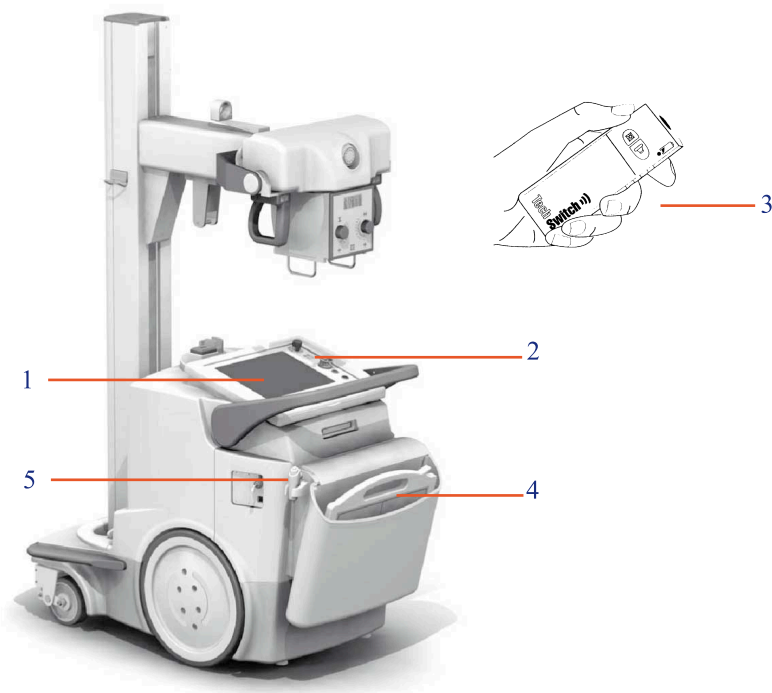

1. Control console
2. Control panel
3. Infrared remote control
4. DR detector
5. Exposure button

**Figure 4: DX-D 100 configuration with portable DR detector**

### Configuration with wireless DR detector

The main operation controls of the DX-D 100 with wireless DR detector.

Depending on the configuration, not all controls may be available.

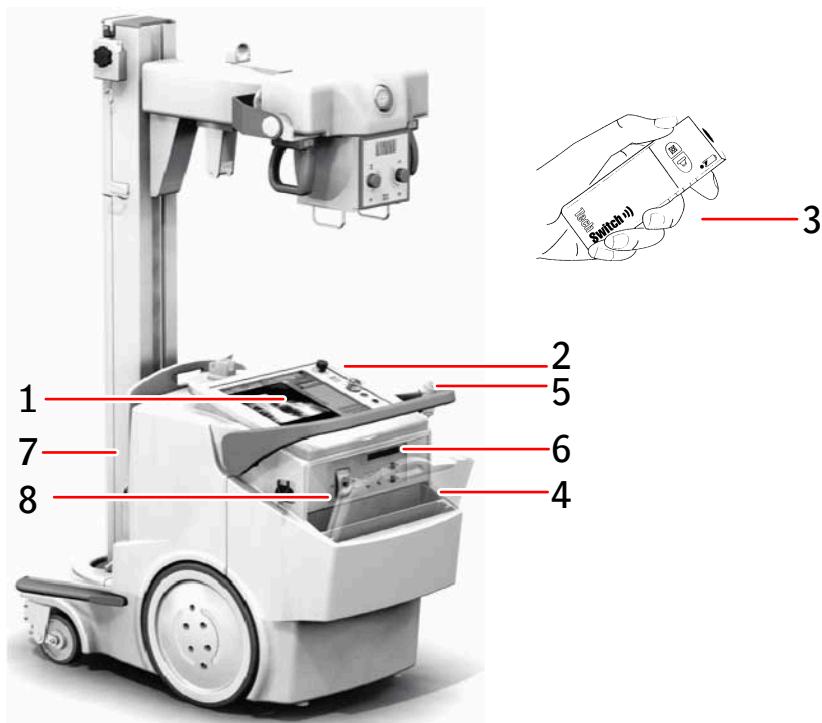

1. Control console
2. Control panel
  - Led beacon light surrounding the control panel (optional)
3. Infrared remote control
4. DR detector
5. Exposure button
6. Depending on the DR detector type:
  - IR data communication unit for registering the DR detector
  - Network connector to plug in the Registration Cable for registering the DR detector. The network connector is marked **ETH**
7. Grid holder with integrated charger for DR detector battery
8. Storage bin with cable for charging a DR detector (optional)

**Figure 5: DX-D 100 configuration with wireless DR detector**

The configuration with wireless DR detector (type number 5411/300) can alternatively be delivered with a fixed DR detector cable mounted to the mobile X-ray unit. In this configuration the wireless operation of the DR detector is not supported.

- [The Control Console](#) on page 19
- [The Control Panel](#) on page 21
- [Infrared remote control](#) on page 22
- [Portable DR detector](#) on page 23
- [Storage bin](#) on page 24

## The Control Console

The control console is displayed on the touch screen of the DX-D 100 mobile X-ray unit. It consists of two parts:

- the NX application, to define patient information, select exposures and process the images
- the software console, to manage X-ray generator settings

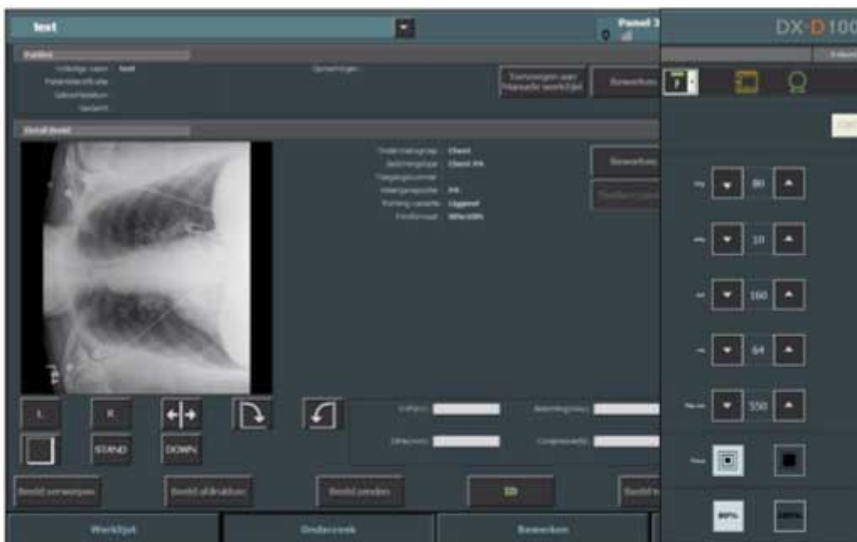

**Figure 6: NX application and DX-D 100 software console**

Whenever you need to type text you can open the “virtual keyboard”.

### Related information

[Using the ‘virtual keyboard’](#) on page 56

### DR Detector Switch

The **DR Detector Switch** is available in the title bar of the MUSICA Acquisition Workstation. The **DR Detector Switch** shows which DR detector is active and shows its status. The **DR Detector Switch** can be used to activate another DR detector.



**Figure 7: DR Detector Switch**

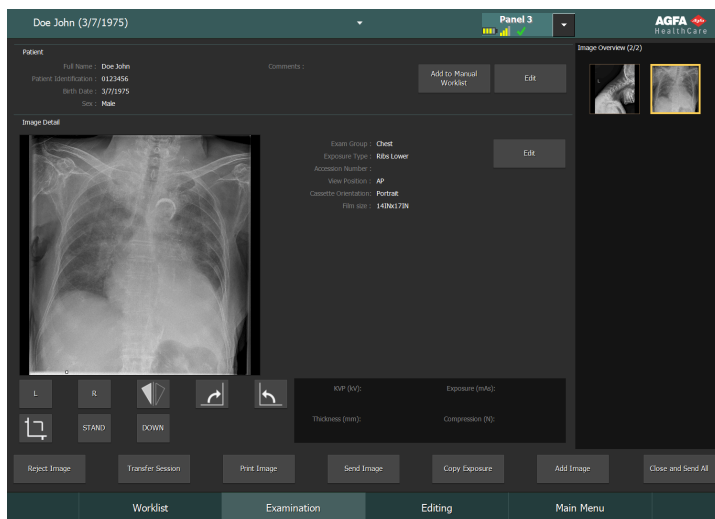













Figure 8: Title bar with DR Detector Switch

<b>Battery status icon</b>					(empty)
<b>Meaning</b>	Full	Medium	Low	Empty	Wired DR Detector Wireless DR detector is off or disconnected

<b>Connection status icon (wifi/wired)</b>					(empty)
<b>Meaning</b>	Good	Low	Bad	Wired DR detector	DR detector is off or disconnected

<b>DR Detector status icon</b>				(empty)
<b>Meaning</b>	DR detector is ready for exposure	DR detector is initializing for exposure (blinking)	DR detector is off or disconnected or in error	DR detector is inactive (no thumbnail selected)

## The Control Panel

The control panel consists of the following items:



1. Emergency switch
2. Battery charge level indicators
3. Switch on/off key (or keypad)
4. Power line connection lamp
5. Collimator lamp

**Figure 9: the control panel**



**Figure 10: Optional keypad replacing the key to switch the unit on and off.**

Following warning is printed on the Control Panel in English:



**Warning:** This x-ray unit may be dangerous to patient and operator unless safe exposure factors, operating instructions and maintenance schedules are observed.

## Infrared remote control

The infrared remote control consists of the following main elements:

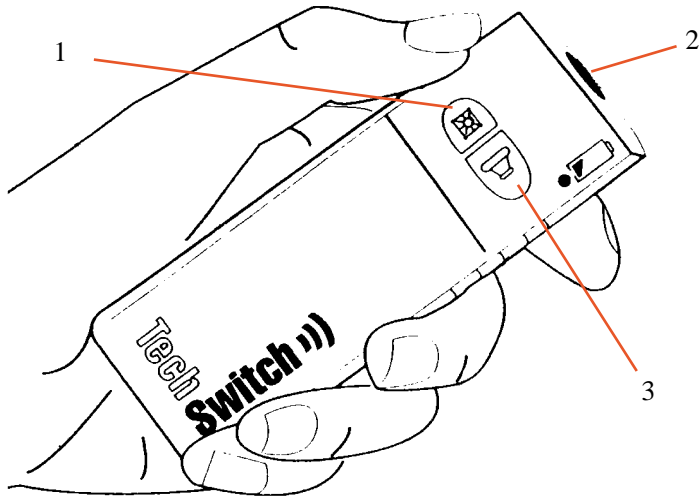



1. Collimator lamp button
2. Infrared window
3. Exposure button

**Figure 11: the infrared remote control**

## Portable DR detector

When performing an exposure, keep in mind the following detector orientation aids:

**Table 1: Orientation aids**

	Tube side icon, indicating the side that faces the X-ray tube
	Patient orientation marker, filled rectangle printed at the corner of the detector, for consistent orientation relative to the patient

For an overview of the operation controls of the DR detector, refer to the user manual of the DR detector.

The DR detector may come in contact with the patient.



**Note** DR detectors that operate wireless contain an RF transmitter. For detailed information, refer to the DR detector user manual.

## Storage bin

The configuration with wireless DR Detector has a storage bin with slots for the specific components of the system.



1. A box or roll of protective bags for the detector

The slot can be used for storing the Allen wrench that is used to uncouple the wheels from the motors.

2. Wireless DR Detector, large format

Slot for positioning the detector to cover it in a protective bag.

3. Detector batteries

(Battery size depends on detector model.)

4. Wireless DR Detector, small format

5. Notepad

**Figure 12: Storage bin**

To cover the DR Detector in a protective bag:



**Figure 13: DR Detector tilted forward in the front slot of the storage bin**

1. Position the DR Detector tilted forward in the front slot of the storage bin.
2. Take a protective bag.
3. Slide the protective bag over the DR Detector.

To clean the storage bin on the inside, take out the partitions of the storage bin.

### Related information

[Storage of Allen wrench](#) on page 33

## System Documentation

---

The documentation shall be kept with the system for easy reference. The most extensive configuration is described within this manual, including the maximum number of options and accessories. Not every function, option or accessory described may have been purchased or licensed on a particular piece of equipment.

Technical documentation is available in the product service documentation which is available from your local support organization.

The user documentation consists of:

- DX-D 100 User Documentation CD (digital media).
- NX User Documentation CD (digital media).
- User documentation for the supported DR Detectors.
- DX-D 100 Owner's Manual (paper binder).
- Getting Started material.
- [The DX-D 100 User Documentation contains:](#) on page 26
- [The Getting Started material contains:](#) on page 26

**The DX-D 100 User Documentation contains:**

- DX-D 100 User Manual (this document), document 0187.
- DX-D 100 Mobile X-Ray Unit User Manual, document 0188.
- DX-D DR Detector Calibration Key User Manual, document 0134.

**The Getting Started material contains:**

- Getting Started with NX, document 4417.
- Getting started with DX-D 100, document 0186.

## Product Complaints

---

Any health care professional (for example a customer or a user) who has any complaints or has experienced any dissatisfaction with the quality, durability, reliability, safety, effectiveness, or performance of this product must notify Agfa.

If, during the use of this device or as a result of its use, a serious incident has occurred, please report it to the manufacturer and/or its authorised representative and to your national authority.

Manufacturer address:

Agfa Service Support - local support addresses and phone numbers are listed on [www.agfa.com](http://www.agfa.com)

Agfa - Septestraat 27, 2640 Mortsel, Belgium

Agfa - Fax +32 3 444 7094

## Classification

Type of protection against electric shock	Class 1 Equipment
Degree of protection against electric shock	Type B Applied Part 
Degree of protection against ingress of liquids	IPX0 as defined in IEC60529. Ordinary equipment (enclosed equipment without protection against ingress of liquids).
Methods of disinfection recommended by the manufacturer	Disinfectable equipment (or elements)
Degree of safety of application in the presence of flammable anesthetic mixture with air or with oxygen or with nitrous oxide	Equipment for use in environments where no flammable gases or vapors are present
Mode of operation	Suitable for continuous operation with intermittent load
Labelling	CE label: 93/42 EEC 'Medical Devices' (Europe), EN 60601-1 CUL label: CSA 22.2 No 601.1 (Canada)
Remarks for HF-emission and immunity	This equipment generates, uses and can radiate radio frequency (RF) energy and, if not installed and used in accordance with the instructions, may cause harmful interference to other devices in the vicinity. In any circumstance; however, there is no guarantee that interference will not occur in a particular installation.

## Compliance

---

The DX-D 100 has been designed in accordance with the MEDDEV Guidelines relating to the application of Medical Devices and have been tested as part of the conformity assessment procedures required by 93/42/EEC MDD (European Council Directive 93/42/EEC on Medical Devices).

The system is compliant with specific directives and standards:

- IEC 60601-1
- IEC 60601-1-2
- [For USA](#) on page 29

### For USA

The system conforms to DHHS radiation Standards of 21CFR subchapter J as of the date of manufacture.

## Connectivity

---

DX-D 100 requires a TCP/IP network to exchange information with a number of other devices. The recommended minimum network performance is 100 Mbit for wired ethernet and IEEE 802.11 g for wireless network.



**Note** A wireless network operating on variable speed or subject to interruptions will cause delays on the NX workstation.

DX-D 100 communicates with other devices in the hospital network using one of the following protocols:

- DICOM
- IHE

DX-D 100 can be connected to a RIS system (input scheduling), a PACS system (output image/data management) and to a hardcopy device (output image).

- [Connecting DX-D 100 to a wired network](#) on page 31
- [Connecting USB devices](#) on page 32

## Connecting DX-D 100 to a wired network

To connect DX-D 100 to a wired network:

1. Place the unit in parking position.

Refer to the DX-D 100 Mobile X-Ray Unit User manual to find out how to do this.

2. Extract the network cable and plug it into a network socket.



**Figure 14: Indication of network cable**

## Connecting USB devices



**Warning:** Only USB devices powered via the USB cable may be connected to a USB port of the PC of the mobile X-ray system. The use of USB devices powered by an AC/DC power supply is strictly forbidden.



**Caution:** The USB device must have been certified acc. to CISPR11 or CISPR22 (or EN 55011 or EN 55022 accordingly), class A (minimum).



**Caution:** If the USB device causes radio interference or disrupts the operation of nearby equipment, it may be necessary re-orient or relocate the device or shielding the location.

## Installation

---



**Caution:** Selecting the wrong DR detector can cause the need to retake the image.

On a configuration with multiple wireless DR Detectors of the same type, it is required to apply labeling to the DR Detector containing a unique nickname for each DR Detector. The nicknames must be configured on the NX workstation. The DR Detector Switch shows which DR Detector is active and shows its status, by means of the nickname of the DR Detector.

- [Storage of Allen wrench](#) on page 33

### Storage of Allen wrench







The unit is delivered with an Allen wrench that is used to uncouple the wheels from the motors in order to move the unit manually. Store the Allen wrench on a fixed location in or near the unit, where it can be easily retrieved in case the motorized movement fails and the unit must be moved manually. The preferred location is the storage bin. On the configuration with wireless DR Detector, the Allen Wrench can be stored in the slot where the protective bags are stored.

#### Related information

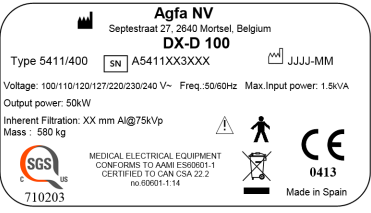
[Storage bin](#) on page 24

## Labels

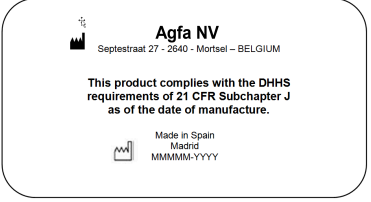
The labels are listed and explained in the relevant modules of the DX-D 100 User Documentation.

 <p>Agfa NV Septestraat 27 - 2640 Mortsel - Belgium <b>DX-D 100</b> Type 5411/400 SN A5411XX3XXX JJJJ-MM Voltage: 100/110/120/127/200/230/240 V~ Freq.:50/60Hz Max.Input power: 1.5kVA Output power: 50kW Inherent Filtration: XX mm Al@75kVp Mass : 580 kg SGS 710203 MEDICAL ELECTRICAL EQUIPMENT CONFORMS TO AAMI ES60601-1 CERTIFIED TO CAN CSA 222 R66001.1:14 CE 0413 Made in Spain</p> <p>(Sample of subtype 5411/300)</p>	<p>Type label positioned on the column.</p> <p>The type label information for each combination of X-ray tube and X-ray generator is available in the technical data.</p>
	<p>This mark shows compliance of the equipment with Directive 93/42/EEC (for European Union).</p>
	<p>Type B applied part</p>
	<p>Date of manufacture</p>
 <p>Agfa NV Septestraat 27 - 2640 - Mortsel - BELGIUM  This product complies with the DHHS requirements of 21 CFR Subchapter J as of the date of manufacture.  Made in Spain Madrid MMMM-YYYY</p>	<p>The 21 CFR Subchapter J label is positioned close to the type label.</p>
 <p>Segurança SGS OCP 0040 Compulsório INMETRO</p>	<p>The INMETRO label is positioned close to the type label.</p>

## Messages

---

Under certain conditions the system shows a dialog box in the middle of the screen containing a message, or a message is displayed in a fixed message area in the user interface. This message informs the user that either a problem has occurred or that a requested action cannot be performed. The user must read these messages carefully. It will provide information on what to do from then on. This will be either performing an action to resolve the problem or to contact the service organization. Details on the contents of messages can be found in the service documentation which is available to service personnel.

## Cleaning and Disinfecting

---

All appropriate policies and procedures should be followed to avoid contamination of the user/staff, patients and other equipment. All necessary precautions shall be taken to avoid patient contact or contact with potential sources of contamination. Cleaning agents and disinfectants should only be used by trained people with required knowledge to complete the cleaning and disinfecting task in a safe and effective way. The selection of the appropriate, legally marketed disinfecting agents and procedures is the responsibility of the hospital. The selection shall be performed according, amongst others, to the severity of the contamination.

- [Cleaning](#) on page 37
- [Disinfecting](#) on page 38
- [Approved disinfectants](#) on page 39

## Cleaning

To clean the exterior of the equipment:

1. Stop the system.



**Caution:** Wet cleaning of the equipment while it is connected to the electric circuit includes the risk of electric shock and of short circuit.

2. Wipe the exterior of the device with a clean, soft, damp cloth. Use a mild soap or detergent if required. Do not use any corrosive, dissolving or abrasive cleaning or polishing agents. Make sure no liquid gets in the device.



**Caution:** Clean the equipment with only a little moisture.



**Note** Do not open the equipment for cleaning. No components inside the device require cleaning by the user.

Using unsuitable cleaning agents or methods can damage the property when surface becomes dull and brittle (e.g. alcohol-containing agents).

3. Start up the system.

## Disinfecting



**Warning:** To disinfect the device, use only disinfectants and disinfection methods that are approved by Agfa and that correspond to the national regulation and guidelines as well as explosion protection.

If you plan to use other disinfectants, approval of Agfa is needed before use, as most disinfectants can damage the device. UV disinfection is also not allowed.

Perform the procedure following the instructions for use, the disposal instructions and the safety instructions of the selected disinfectants and tools and of the hospital.

Items contaminated with blood or body fluids, which may contain blood-borne pathogens, should be cleaned and then receive intermediate level disinfection with a product having an EPA-registered claim for activity against hepatitis B.

## Approved disinfectants

Refer to the Agfa website for specifications on the disinfectants that have been found compatible with the cover material of the device and can be used on the outer surface of the device.

<https://www.agfa.com/he/global/en/internet/library/overview.jsp?ID=41651138>

## Patient data security

---

The user must ensure that the patients' legal requirements are met and that the security of the patient data is guarded.

The user must define who can access patient data in which situations.

The user must have a strategy available on what to do with patient data in case of a disaster.

- [RFID key lost or stolen](#) on page 40

### RFID key lost or stolen

The user must have a process in place to revoke lost or stolen RFID keys.









## Maintenance

---

Maintenance procedures are described in the DX-D 100 Mobile X-Ray Unit User Manual and in the DR Detector user manuals.







## Safety Directions

---

-  **Warning:** Only qualified and authorized personnel shall operate this system. In this context ‘qualified’ means those persons legally permitted to operate this equipment in the jurisdiction in which the equipment is being used, and ‘authorized’ means those persons authorized by the authority controlling the use of the equipment. Full use must be made of all radiation protection features, devices, systems, procedures and accessories.
-  **Warning:** Improper changes, additions, maintenance or repair of the equipment or the software can lead to personal injury, electrical shock and damage to the equipment. Safety is only guaranteed when changes, additions, maintenance or repairs are carried out by an Agfa certified field service engineer. A non certified engineer performing a modification or service intervention on a medical device, acts on his own responsibility and makes the warranty void.
-  **Warning:** System unavailability due to hardware or software failure. If the product is used in critical clinical workflows, a backup system has to be foreseen.
-  **Warning:** Do not connect the equipment with anything other than specified. Doing so may result in fire or electric shock.
-  **Warning:** Do not connect additional extensions cords or multiple power socket outlets to the system.
-  **Warning:** According to MDD/93/42/EEC, this unit is equipped with EMC filters. The lack of proper grounding may produce electrical shock.
-  **Warning:** To avoid risk of electric shock, do not remove any covers. Changes, additions, maintenance or repairs must be carried out by an Agfa certified field service engineer.
-  **Warning:** Do not drive the unit on ramps with an inclination higher than 5 degrees.
-  **Warning:**

To avoid the risk of overbalance, the mobile unit must not be in stationary position on surfaces with the following inclination angles:

  - with the arm in parking position: greater than 10°
  - with the arm out of parking position: greater than 5°

if for any reason the unit exceeds the indicated inclination angles and loses the verticality, the arm could rise sharply to the top of the column. This could cause personal injury and/or damage to the equipment.
-  **Warning:** Exceeding speed while driving from a ramp. To drive from a ramp safely, reduce the speed by intermittently releasing the drive handle.
-  **Warning:** Do not operate the touch screen monitor with wet hands.
-  **Warning:** Do not let liquids come in contact with the touch screen while the system is powered on.
-  **Warning:** Always double check your exposure parameter settings prior to exposing the patient.
-  **Warning:** As the cables of the equipment are long, be careful not to entangle the cables during use. Also, be careful not to trip over the cables. Falls could result in injury.
-  **Warning:** Unplugging the detector immediately after exposure may cause image loss.



**Caution:** Avoid unnecessary dose by checking before exposure if the DR Detector Switch displays the name of the DR Detector that is being used and if the status of the DR Detector is ready for exposure.



**Caution:** The unit is equipped with a safety switch in the drive handle. If the drive handle is released the unit will stop. In case of unintended movement, do not try to correct the units' movement via the drive handle but release the drive handle immediately to stop the unit. If you experience unintended movement, the unit has to be taken out of operation. Please notify your Agfa service contact at once.



**Caution:** Excessive ambient temperature may impact performance of DR Detectors and cause permanent damage to the equipment. Refer to the related user manual for environmental conditions for the DR detector. If ambient temperature and humidity is outside the specified range, do not operate the system or use air conditioning. Frost due to low temperatures can damage internal circuits. Warranty will be void if it is obvious that operating conditions are not met.



**Warning:** Damaged grid. Reduced image quality. Please handle the grids with special care.

For directions concerning X-ray radiation safety, electrical safety and electromagnetic safety, refer to the DX-D 100 Mobile X-Ray Unit User Manual, document 0188.

- [Cleaning the system](#) on page 44
- [Disinfection of the system](#) on page 44
- [Emergency stop button](#) on page 45

## **Cleaning the system**

- Shut down the system properly before cleaning.
- No moisture may penetrate into the system.
- Refer also to the relevant modules of the DX-D 100 User Documentation.

## **Disinfection of the system**

- Shut down the system before cleaning.
- Only those disinfection methods which satisfy the applicable regulations and directives as well as explosion protection may be used.
- Refer also to the relevant modules of the DX-D 100 User Documentation.

## Emergency stop button

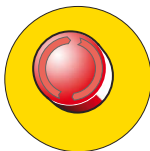

**Figure 15: Emergency stop button**

If a system malfunction causes an emergency situation involving the patient, operating personnel or any system component, activate the emergency stop. The mobile X-ray unit will be turned off.

For detailed information about the emergency button/switch, refer to the DX-D 100 Mobile X-Ray Unit User Manual (document 0188).



**Caution:** Using the emergency stop also shuts down the NX application and can cause image loss.



**Caution:** After an examination, send images to a hardcopy printer and/or PACS as soon as possible.

To stop DX-D 100 under normal conditions, refer to the procedure for stopping DX-D 100.

### Related information

[Stopping DX-D 100](#) on page 64

## Environmental protection

---



Figure 16: WEEE symbol

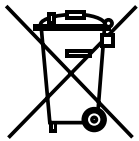

Li

Figure 17: Battery symbol

### WEEE end user notice

The directive on Waste Electrical and Electronic Equipment (WEEE) aims to prevent the generation of electric and electronic waste and to promote the reuse, recycling and other forms of recovery. It therefore requires the collection of WEEE, recovery and reuse or recycling.

Due to the implementation into national law, specific requirements can be different within the European Member States. The WEEE symbol on the products, and/or accompanying documents means that used electrical and electronic products should not be treated as, or mixed with general household waste. For more detailed information about take-back and recycling of this product please contact your local service organization and/or dealer. The recycling of materials will help to conserve natural resources.



**Caution:** By ensuring this product is disposed of correctly, you will help prevent potential negative consequences for the environment and human health, which could otherwise be caused by inappropriate waste handling of this product.

### Battery notice

The battery symbol on the products, and/or accompanying documents means that the used batteries should not be treated as, or mixed with general household waste. The battery symbol on batteries or its packaging may be used in combination with a chemical symbol. In cases where a chemical symbol is available it indicates the presence of respective chemical substances. If your equipment or replaced spare parts contain batteries or accumulators please dispose of them separately according to local regulations.

For battery replacements please contact your local sales organization.

# Getting started

---

- [Starting DX-D 100](#) on page 48
- [Operating DX-D 100](#) on page 50
- [Stopping DX-D 100](#) on page 64
- [Stopping the MUSICA Acquisition Workstation by logging out of Windows](#) on page 65

## Starting DX-D 100

To start DX-D 100:

1. Unplug the unit from the mains power.
2. Unlock the device.
  - To unlock the device using the key, switch the key on the control panel to the “ON” position.

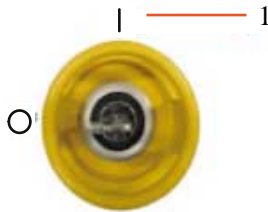

**1. “ON” position**

- To unlock the device using the on/off keypad, press and hold the power button until the green status indicator light starts blinking, dial the four digit access code and press the enter button.



**1. Power button**

**2. Enter button**

The X-ray generator is powered on.

The Windows log in window appears.

3. Log in to Windows.
  - To log in using your password, enter your user name and password and click **OK**.
  - To log in using the optional RFID reader, select the Aloaha login method, touch the RFID reader with your personal RFID key and click **OK**.

The NX application and the software console become available on the control console.

For detailed information about starting up NX, refer to the NX User Manual, document 4420.

4. On the control panel, check the battery levels.
 

If the red indicator is blinking, operation is not allowed. In that case, it is necessary to charge the batteries.
5. In a configuration with a wireless DR Detector, power on the DR Detector:
  - attach a fully charged battery pack to the DR Detector.
  - turn on the DR Detector.
  - if needed, register the DR Detector to the DX-D 100 X-Ray System.
6. At the start of each day and when the selected tube has not been in use for approximately one hour, perform the X-ray tube warm-up as follows:
  - Close the collimator blades fully.
  - On the Control Console, display the software console by clicking the **SC** button.
  - Select the free exposure workstation.
  - Select 70 kV, 100 mAs, 200 mA and 500 ms exposure.
  - Make sure that no one will be exposed.

- Make a total of three exposures, 15 seconds apart.

## Operating DX-D 100

---

The DX-D 100 can be operated in two different ways: connected to a wired network or using a wireless network.

In the basic workflow described below, the situation using a wireless network is described. Whenever the situation with a wired network requires an exception this is clearly indicated.

- [Displacement and positioning workflow](#) on page 51
- [Basic imaging workflow](#) on page 53
- [Using the 'virtual keyboard'](#) on page 56
- [Barcode reader](#) on page 57
- [Charging a DR Detector battery](#) on page 58
- [Charging a DR detector in the storage bin](#) on page 59
- [Managing the access codes for the on/off keypad](#) on page 60
- [Managing the RFID reader for user authentication](#) on page 61

## Displacement and positioning workflow



**Caution:** Before using DX-D 100, check the battery levels on the control panel. If the red indicator is blinking, operation is not allowed. In that case, it is necessary to charge the batteries.

### Driving the unit



**Note** If you use a wired network the network cable must be unplugged to be able to perform this step.

1. Grip and hold the locking bar towards the handlebar.

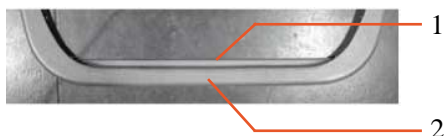

1. Locking bar
  2. Handlebar
2. Push the handlebar with both hands to drive forwards.  
Apply different pressure on the left and the right to steer the unit.
  3. Release the locking bar to block motion.

### Releasing the arm

1. Press the brake control at the tube-collimator handles to release the arm from parking position.



2. Press and hold the brake control while using the handles to rotate the column and move the arm horizontally and vertically.



**Warning:** Monitor with special care the patient position or anyone present, to avoid injury caused by unit movements. Intravenous tubing, catheters and other patient connected lines should be routed away from moving equipment.

### Positioning the unit

Use the motion controls to adjust the position of the unit with respect to the patient.

The four buttons on the tube-collimator handles control the motion of each driving wheel (forwards/backwards).

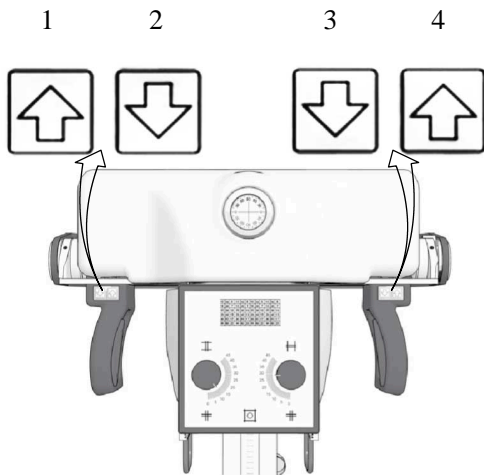

1. Backwards to the right
2. Forwards to the right
3. Forwards to the left
4. Backwards to the left

#### **Positioning the X-ray tube and collimator**

Use the tube-collimator handles to rotate the X-ray tube on its transversal or horizontal axis or to rotate the collimator on its vertical axis.

## Basic imaging workflow

### Retrieving the patient info



**Note** If you use a wired network the network cable must be plugged in to be able to perform this step.

1. On the RIS, schedule the examinations.
2. In NX, query the RIS.
3. Define the patient info for the examination.
4. Start the examination.



**Note** If the patient cannot be retrieved from the RIS you should enter patient data manually. In that case, you can use the 'virtual keyboard'.

### Related information

[Using the 'virtual keyboard'](#) on page 56

### Selecting the exposure

In NX, select the thumbnail for the exposure in the Image Overview pane of the Examination window.

The DR Detector is activated. The DR Detector Switch shows which DR Detector is active and shows its status.

The DX-D 100 software console is displayed and the default X-ray exposure parameters for the selected exposure are displayed.

### Preparing the exposure

1. Check the position of the X-ray unit and the patient.



**Warning:** Liquids ingressing the DR Detector may cause malfunction and contamination.

If there is a chance that the detector comes in contact with liquids (bodily fluids, disinfectants,...), the DR Detector must be wrapped in a protective plastic bag while performing the examination.

- If a filter is used, mount the filter to the collimator.
- If a grid is used, attach the grid to the detector.

2. Switch on the light localizer on the collimator. Adapt collimation if required.



**Figure 18: Collimator light**



**Caution:** Misalignment of the DR Detector and the X-ray tube causes unnecessary exposure of the patient to radiation.

## Checking the exposure settings

### On the NX application

1. Check if the DR Detector Switch displays the name of the DR Detector that's being used
2. If a wrong DR Detector is displayed, select the right DR Detector by clicking the drop down arrow on the DR Detector Switch.

### On a DR Detector that has a status indicator

Check if the status of the DR Detector is ready for exposure. If the status is not ready for exposure, the DR Detector cannot be used for making an exposure.

### On the Software Console

1. Check if the exposure settings displayed on the console are suitable for the exposure.  
If other exposure values are required than those defined in the NX exam, use the console to overwrite the default defined exposure settings.
2. Check if the status of the DR Detector is ready for exposure.

### On the control panel



**Warning:** Check if the led beacon light lights up green.

This indicates that the wireless DR Detector and the X-ray generator are ready for making an exposure.

## Executing the exposure

1. Take a safe distance from the X-ray tube.



**Caution:** Excessive user or operator radiation exposure. Always keep a distance of at least 2 meters from the focal spot and X-ray beam, protect body and do not expose hands, arms or other parts of the body to the primary beam.

2. On the handswitch or on the remote control, press the exposure button to execute the exposure.

The exposure is sent to NX.



**Warning:** During exposure ionizing radiation is emitted by the X-ray system. To indicate the presence of ionizing radiation, the radiation indicator on the control console lights up.



**Caution:** Do not select another thumbnail until the preview image is visible in the active thumbnail. The acquired image may be linked to the wrong exposure.

In NX:

- While the acquisition is ongoing, the X-ray on indicator is displayed on the software console. The led beacon light lights up yellow.
- The image is acquired from the DR Detector and displayed in the thumbnail.
- The software console disappears.
- If collimation is applied, the image is automatically cropped at the collimation borders.
- The actual X-ray exposure parameters are shown in the Image Detail pane.

## Performing a quality control

In NX:

1. Select the image on which quality control is to be performed.
2. Prepare the image for diagnosis by using e.g. L/R markers or annotations.
3. If the image is OK, send the image to a hardcopy printer and/or PACS (Picture Archiving and Communication System).



**Note** If you use a wired network, the MUSICA Acquisition Workstation can only send images if the network cable is plugged in.





**Note** If you use a wired network, the MUSICA Acquisition Workstation may display error messages while working unplugged because it cannot send images. To prevent error messages being displayed, halt the send queue and restart it when plugging in the network cable. Refer to the MUSICA Acquisition Workstation User Manual.

## Using the 'virtual keyboard'

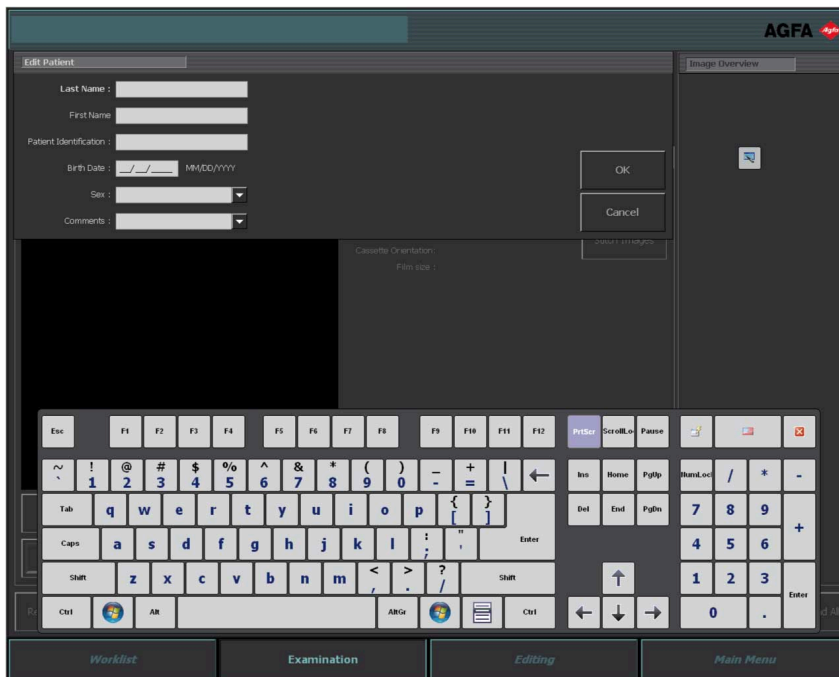
When selecting a text field, the virtual keyboard is displayed:

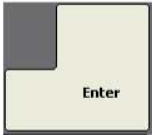

Button	Function
	Enter button
	Close button
	Floating virtual keyboard button

After entering text, select another text field to continue typing or hide the virtual keyboard by clicking the Enter button.

If the virtual keyboard is not displayed automatically or if the virtual keyboard is in the way, click the floating virtual keyboard button.

 **Note** Clicking the Close button may cause the virtual keyboard to remain hidden when entering the text field again.

### Restriction on the use of virtual keyboard software

DX-D 100 contains software components licensed from Comfort Software Group. These products may only be used as part of and in connection with DX-D 100.

 **Note** For using the virtual keyboard, it is recommended to use the IntelliTouch stylus pen that is delivered with the system.

**Barcode reader**

Refer to the Agfa website for specifications of supported barcode readers.

<https://www.agfa.com/he/global/en/internet/library/overview/?ID=80502528>

## Charging a DR Detector battery

Depending on the configuration, the grid holder includes a charger for a specific model of DR Detector batteries.

To charge a DR Detector battery:

1. Insert the battery in the charger.
2. Lock the battery in place if it has a fixation mechanism.

The DR Detector battery is being charged while the mobile X-ray unit is in operation or while it is connected to the mains power.

## Charging a DR detector in the storage bin

Depending on the configuration, the storage bin is equipped with a cable that can be connected to an XD 10, XD\*10, XD 14, XD\*14, XD 17, XD\*17, XF\*10, XF\*14 or XF\*17 detector, to charge the DR detector battery.

To charge a DR detector battery:

1. Insert the DR detector in the storage bin with the cable connector facing upwards.
2. Connect the cable to the DR detector.

The battery status can be read from the DR detector status display.

The DR detector battery is being charged while the mobile X-ray unit is in operation or while it is connected to the mains power.

3. While the cable is not in use, attach its connector safely to the connector holder.

## Managing the access codes for the on/off keypad

One or more access codes can be configured for unlocking the on/off keypad.



1. Power button
2. Status indicator lights
3. Enter button

### Modifying the access code

1. Shut down the system.
2. Press and hold the power button until the green status indicator light starts blinking.
3. Press and hold the enter button until the blue status indicator light starts blinking.
4. Dial the access code and press the enter button.

The blue status indicator light is lit.

5. Press and hold the number 2 button until the blue status indicator starts blinking fast.
6. Dial the new four digit access code and press the enter button.

The green status indicator light is blinking.

The new access code replaces the original access code.

### Adding an extra access code

1. Shut down the system.
2. Press and hold the power button until the green status indicator light starts blinking.
3. Press and hold the enter button until the blue status indicator light starts blinking.
4. Dial the access code and press the enter button.

The blue status indicator light is lit.

5. Press and hold the number 1 button until the blue status indicator starts blinking fast.
6. Dial the new four digit access code and press the enter button.

The green status indicator light is blinking.

The device can now be unlocked using the new access code as well.

### Deleting an access code

1. Shut down the system.
2. Press and hold the power button until the green status indicator light starts blinking.
3. Press and hold the enter button until the blue status indicator light starts blinking.
4. Dial the access code and press the enter button.

The blue status indicator light is lit.

5. Press and hold the number 3 button until the blue status indicator starts blinking fast.

The blue status indicator light is blinking fast for a while, then the green status indicator light is blinking.

The access code cannot be used anymore to unlock the device.

## Managing the RFID reader for user authentication

In order for a user to be able to log in to Windows using his personal RFID key, the user must be configured on the DX-D 100.

Each RFID key must be linked to a Windows user account.

Multiple RFID keys can be linked to the same Windows user account.

An RFID key can be configured on more than one DX-D 100 system.

### Adding an RFID key card to the configuration of the RFID reader

1. On the NX workstation, go to the **Main Menu**.
2. Click the **Show Desktop** action button.  
The Windows desktop is shown.
3. Go to the Windows **Start menu** > **Aloaha** > **Keycard Credentials** and click **Keycard Credentials**.

The **Keycard Credentials** dialog is displayed.

**Figure 19: Keycard Credentials**

4. Enter the Windows username
5. Enter the domain name if needed.  
For a local user, leave the field blank.
6. Enter the password.
7. Enter the password again.
8. Enter PIN code 0102.
9. Touch the RFID reader with the new RFID key.
10. Click **Save**.

A confirmation dialog is displayed.

11. Click **OK**.

### Updating the password of a user

If the password of a user has been changed on Windows, the user password must also be updated in the Keycard Credentials tool.

If multiple RFID keys are linked to this Windows user account, the procedure must be repeated for each RFID key.

To do this, you need the user's keycard and the new password.

1. Go to the Windows **Start menu** > **Aloaha** > **Keycard Credentials** and click **Keycard Credentials**.

The **Keycard Credentials** dialog is displayed.

**Figure 20: Keycard Credentials**

2. Touch the RFID reader with the user's RFID key.
3. Enter PIN code 0102.
4. Push the button **Refresh list above**.  
In the **Accounts for card** field, the connected user will appear.
5. Click the user account.  
The user name is copied to the **Username** field.
6. Enter the new password.
7. Enter the new password again.
8. Click **Save**.  
A confirmation dialog is displayed.

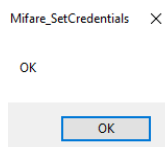

9. Click **OK**.

### Removing an RFID key card from the configuration of the RFID reader

If a card is lost, or the card needs to be configured for another user, it is best to remove the card's configuration from the configuration list.

1. Read the card's serial number.

- Method 1.

Use a smartphone with NFC reader possibilities and read the serial card number.

- Method 2.

Use an existing application from Aloaha

C:\Program files (x86)\Aloaha\Keycard\_ChangePIN.exe

Start the application, apply a card to the reader and press the **Serials** button. The serial number will be shown.

2. Go to `C:\Program Files(x86)\Aloaha\SerialStore`
3. Find the file that matches the card's serial number and delete the file.

### **Copying the configuration of the RFID reader to another DX-D 100 system**

The configuration of the RFID reader can be copied to other systems.



**Note** A configuration can only be copied if the windows usernames and password are the same on both systems.

1. Go to `C:\Program Files(x86)\Aloaha\SerialStore`.
2. Copy all the txt files to the same directory on the other system.

## Stopping DX-D 100

To stop DX-D 100:

1. Stop NX and shut down the PC from the Windows Start menu or login window.
2. Put the unit in parking position.
  - a) Use the tube-collimator handles to restore the default position of the collimator and the X-ray tube.
  - b) Press and hold the brake control while using the handles to fully retract the telescopic arm and turn the column until the parking detent is aligned with the catch.
  - c) Lower the arm and fully insert the parking detent into the catch.



**Warning:** Lowering the arm when the telescopic arm is not fully retracted, can trigger the handle bar and cause unintended displacement of the equipment. Fully retract the telescopic arm before lowering the arm.

3. Lock the device.
  - To lock the device using the key, switch the key on the control panel to the “OFF” position.

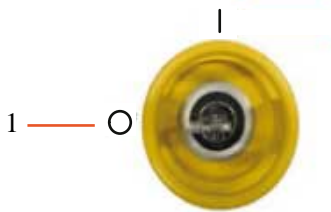

1. “OFF” position

- To lock the device using the on/off keypad, press and hold the power button until the green status indicator light goes out.



1. Power button
2. Enter button

Two minutes remain before shutdown. The X-ray generator and the DR Detector are powered off.

4. In a configuration with wireless DR Detector, power off the DR Detector:
  - a) turn off the DR Detector,
  - b) remove the battery pack.

## Stopping the MUSICA Acquisition Workstation by logging out of Windows

---

1. Go to the **Main Menu**.
2. Click the **Log Off** button.

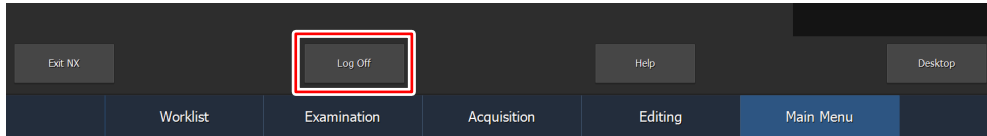

**Figure 21: Log Off button**

3. The third step.

As a result:

- The NX software is closed.
- The Windows user is signed out.
- It is still possible to drive the unit.

## Problem solving

---

- [Corner area of detector not exposed](#) on page 67
- [Motorized movement has stopped and unit cannot be moved](#) on page 68

## Corner area of detector not exposed

Details	A small area in the corner of the detector has not been exposed.
Cause	When making an exposure with small source-image distance (e.g. 1 m) and with the collimator in rotated position (e.g. 45°), the X-ray field does not reach to the outer corners of the collimated area.
Solution	Increase the source-image distance.

## Motorized movement has stopped and unit cannot be moved

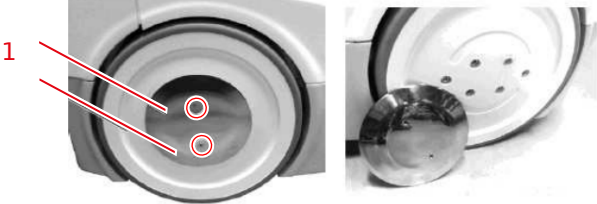
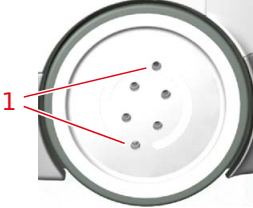
Details	The motorized movement has stopped because the unit is switched off or a problem has occurred. The unit cannot be moved.
Cause	The wheels are blocked.
Solution	<p>To move the unit manually:</p> <ol style="list-style-type: none"> <li>1. If the wheels have a hubcap, dismount the hubcap from the wheel rim by removing the two fixing screws. Take care not to lose these screws and the spacers located behind the hubcap.</li> </ol>  <ol style="list-style-type: none"> <li>1. Hubcap fixing screws</li> <li>2. Remove the two clutch screws (Allen type) located on each wheel using the Allen wrench provided with the unit.</li> </ol> <p>This will uncouple the wheels from the motors (releasing the brakes) allowing the free motion of the unit.</p>  <ol style="list-style-type: none"> <li>1. Clutch screws</li> <li>3. To reassemble the hubcap, place the two spacers in the original position, mount the hubcap and secure it with the two fixing screws.</li> </ol>

### Related information

[Storage of Allen wrench](#) on page 33

[Storage bin](#) on page 24

## Technical Data

---

- [DX-D 100 Technical Data](#) on page 69

### DX-D 100 Technical Data

---

The technical data are provided in this chapter or in the User Manual of the component.

**Table 2: Electrical connection**

Rated power supply	100 / 110 / 120 / 127 / 220 / 230 / 240 VAC Single-phase 50 / 60 Hz Automatic Line Compensation $\pm 10\%$ VAC Connection to standard outlets with GND that complies with local regulations
Standard outlet	The general circuit breaker installed in the mobile unit is 10 A (1P +N curve type D), the power line installation should be provided with a differential of 30 mA sensitivity and with a thermomagnetic wswitch / circuit breaker of: $\geq 13$ A (curve type D) or $\geq 20$ A (curve type C) or $\geq 32$ A (curve type B).
Line resistance	1.2 $\Omega$ for 110 VAC, 2.5 $\Omega$ for 230 VAC

**Table 3: Environmental conditions of the mobile X-ray unit**

Environmental Conditions (during storage and transport)	
Temperature (ambient)	between -20 and 40 degrees Celsius
Humidity (non condensing)	between 10 and 90 % relative humidity
Atmospheric pressure	between 50 and 106 kPa
Environmental Conditions (during normal operation)	
Temperature (ambient)	between 10 and 35 degrees Celsius
Humidity (non condensing)	between 30 and 75 % relative humidity
Atmospheric pressure	between 70 and 106 kPa

For overall system environmental conditions, the environmental conditions of the portable DR detector should be taken into account. Refer to the DR Detector User Manual for environmental conditions for the DR detector.

- [DR Detector Technical Data](#) on page 70
- [Mobile X-Ray Unit Technical Data](#) on page 70

## **DR Detector Technical Data**

Refer to the DR Detector User Manual.

## **Mobile X-Ray Unit Technical Data**

Refer to the DX-D 100 Mobile X-Ray Unit User Manual (document 0188).