

XD 14, XD+14

FXRD-3643VAW
FXRD-3643VAW PLUS

User Manual



Contents

Legal Notice.....	5
Introduction to this Manual.....	5
Scope.....	6
About the safety notices in this document.....	7
Disclaimer.....	8
Introduction to the DR Detector.....	8
Intended use.....	9
Intended User.....	10
Configuration.....	11
Equipment Classification.....	12
Non-medical equipment.....	12
Options and Accessories.....	13
Anti-scatter grids.....	13
Operation Controls.....	14
XD 14, XD*14.....	15
DR detector charging stand.....	17
DR Detector dual battery charger.....	18
System Control Unit.....	19
System Control Unit Lite.....	20
DR detector cable.....	21
DR Detector Switch.....	22
System Documentation.....	24
Wireless access point.....	24
Training.....	25
Product Complaints.....	26
Compatibility.....	27
Compliance.....	28
General.....	29
Safety.....	29
Electromagnetic Compatibility.....	29
Radio Frequency.....	30
Connectivity.....	31
Wireless Communication.....	32
Wired communication.....	33
Installation.....	34
Environment of Use.....	34
Messages.....	36
Labels.....	37
Additional labeling of the DR detector.....	40
Additional labeling of the DR detector battery.....	41
Additional labeling of the DR detector charging stand.....	42
Additional labeling of the DR detector dual battery charger.....	43
Additional Labeling of the System Control Unit.....	44
Additional Labeling of the Mini System Control Unit.....	45
Additional Labeling of the System Control Unit Lite.....	46

Cleaning and Disinfecting.....	47
Cleaning.....	48
Use of protective plastic bag.....	49
Disinfecting.....	50
Approved disinfectants.....	51
Safety directions for disinfection.....	52
Maintenance.....	53
Daily inspection.....	54
Half-yearly inspection.....	55
Regular Inspection and Maintenance.....	56
Replacement Parts Support.....	57
Repair.....	58
Patient data security.....	59
Requirements on the operating environment.....	59
Environmental Protection.....	61
Safety Directions.....	62
Safety directions for the power supply.....	65
Safety directions for the System Control Unit.....	66
Safety directions for the DR detector battery.....	67
Getting started.....	68
Starting the DR detector.....	69
Basic Workflow DR Detector.....	71
Step 1: retrieve the patient info.....	72
Step 2: select the exposure.....	72
Step 3: prepare the exposure.....	73
Step 4: check the exposure settings.....	74
Step 5: execute the exposure.....	75
Step 6: perform a quality control.....	76
Positioning the XD 14, XD*14.....	77
Offline image acquisition workflow.....	80
Guidelines for Pediatric Applications.....	83
Stopping the DR detector.....	84
Automatic exposure detection.....	85
Attaching the handle unit with anti-scatter grid.....	86
Attaching the handle unit without anti-scatter grid.....	87
Advanced Operating.....	87
Viewing the detector status.....	88
Battery status.....	89
Connection status.....	90
Charging a battery.....	91
Charging the DR detector in the DR detector charging stand.....	92
Charging the DR detector using the power adapter.....	93
Charging the battery using the DR detector cable.....	94
Charging a battery in the dual battery charger.....	95
Replacing the battery.....	96
Managing network connections in client mode configuration.....	97
Connecting to another MUSICA Acquisition Workstation (client mode).....	97
Managing network connections in access point mode configuration.....	98
Switching between the wireless DR detector and the wireless hospital network.....	99
Switching temporarily to client mode.....	101
Connecting the MUSICA Acquisition Workstation to another DR detector (access point mode).....	102

Problem solving.....	102
Artifact in DR Detector images.....	103
DR detector not ready for exposure.....	104
The MUSICA Acquisition Workstation is connected to the DR detector, but the DR detector is not active (access point mode).....	105
Images are not sent to the printer or to the PACS archive.....	106
Identifying problems.....	107
Technical Data.....	107
XD 14, XD*14 technical data.....	109
DR detector battery technical data.....	111
DR detector charging stand technical data.....	112
DR detector dual battery charger technical data.....	113
System Control Unit.....	114
Mini System Control Unit.....	115
System Control Unit Lite.....	116
Remarks for HF-emission and immunity.....	116
EMC (Electromagnetic Compatibility) Statements.....	117
Electromagnetic emissions.....	118
Electromagnetic immunity.....	119
For U.S.A.....	121

Legal Notice



2460



Vieworks Co., Ltd., 41-3, Burim-ro 170beon-gil, Dongan-gu, Anyang-si, Gyeonggi-do, 14055 Republic of Korea

For more information on Agfa products, please visit agfaradiologysolutions.com.

Agfa and the Agfa rhombus are trademarks of Agfa-Gevaert N.V., Belgium or its affiliates. XD 14 and XD*14 are trademarks of Agfa NV, Belgium or one of its affiliates. All other trademarks are held by their respective owners and are used in an editorial fashion with no intention of infringement.

Agfa NV makes no warranties or representation, expressed or implied, with respect to the accuracy, completeness or usefulness of the information contained in this document and specifically disclaims warranties of suitability for any particular purpose. Products and services may not be available for your local area. Please contact your local sales representative for availability information. Agfa NV diligently strives to provide as accurate information as possible, but shall not be responsible for any typographical error. Agfa NV shall under no circumstances be liable for any damage arising from the use or inability to use any information, apparatus, method or process disclosed in this document. Agfa NV reserves the right to make changes to this document without prior notice. The original version of this document is in English.

Copyright 2024 Agfa NV

All rights reserved.

Published by Agfa NV

2640 Mortsels - Belgium.

No part of this document may be reproduced, copied, adapted or transmitted in any form or by any means without the written permission of Agfa NV

Introduction to this Manual

- [Scope](#) on page 6
- [About the safety notices in this document](#) on page 7
- [Disclaimer](#) on page 8

Scope

This manual contains information for the safe and effective operation of the XD 14 and XD*14 wireless DR detectors and peripheral equipment, further referred to as the DR detector.

About the safety notices in this document

The following samples show how warnings, cautions, instructions and notes appear in this document. The text explains their intended use.



DANGER: A danger safety notice indicates a hazardous situation of direct, immediate danger for a potential serious injury to a user, service engineer, patient or any other person.



Warning: A warning safety notice indicates a hazardous situation which can lead to a potential serious injury to a user, service engineer, patient or any other person.



Caution: A caution safety notice indicates a hazardous situation which can lead to a potential minor injury to a user, service engineer, patient or any other person.



An instruction is a direction which, if it is not followed, can cause damage to the equipment described in this manual or any other equipment or goods and can cause environmental pollution.



A prohibition is a direction which, if it is not followed, can cause damage to the equipment described in this manual or any other equipment or goods and can cause environmental pollution.



Note Notes provide advice and highlight unusual points. A note is not intended as an instruction.

Disclaimer

Agfa assumes no liability for use of this document if any unauthorized changes to the content or format have been made.

Every care has been taken to ensure the accuracy of the information in this document. However, Agfa assumes no responsibility or liability for errors, inaccuracies or omissions that may appear in this document. To improve reliability, function or design Agfa reserves the right to change the product without further notice. This manual is provided without warranty of any kind, implied or expressed, including, but not limited to, the implied warranties of merchantability and fitness for a particular purpose.



Note In the United States, Federal law restricts this device on order of a physician for prescription use only.

Introduction to the DR Detector

- [Intended use](#) on page 9
- [Intended User](#) on page 10
- [Configuration](#) on page 11
- [Equipment Classification](#) on page 12
- [Options and Accessories](#) on page 13
- [Operation Controls](#) on page 14
- [System Documentation](#) on page 24
- [Training](#) on page 25
- [Product Complaints](#) on page 26
- [Compatibility](#) on page 27
- [Compliance](#) on page 28
- [Connectivity](#) on page 31
- [Installation](#) on page 34
- [Messages](#) on page 36
- [Labels](#) on page 37
- [Cleaning and Disinfecting](#) on page 47
- [Maintenance](#) on page 53
- [Patient data security](#) on page 59
- [Environmental Protection](#) on page 61
- [Safety Directions](#) on page 62

Intended use

Indications for use

The XD 14 and XD*14 DR detectors are a digital X-ray imaging solution. They acquire images by detecting X-rays that has been passed through the human body. When X-ray photons pass through the scintillator in the detector, the photons convert to visible ray, and the visible ray is converted to electronic signals through TFTs – thin film transistors (a-Si). Then the detector digitalizes X-ray images and transfers them to the PC (workstation) for diagnostic review using an image display monitor. Advanced digital image processing also allows efficient diagnosis, information management, and sharing of image information over the network.

The XD 14 and XD*14 DR detectors are used to examine patients with or suspected of muscle and bone injury, respiratory diseases. It is intended for general patients such as adults, children, and infants, but all radiography should be reviewed by a doctor in charge prior to beginning the examination. The radiologist should use a proper technique considering the patient's size to decrease the radiation dose when acquiring diagnostic images.

The XD 14 and XD*14 DR detectors are not intended for mammography applications.

The XD 14 and XD*14 DR detectors can also be used for veterinary applications.

Intended User

This manual is written for trained users of Agfa products. Users are considered as the persons who actually handle the equipment as well as the persons having authority over the equipment. Before attempting to work with this equipment, the user must read, understand, note and strictly observe all warnings, cautions and safety markings on the equipment.

Only a physician or a legally certified operator should use this product.

Configuration

The DR detector is a component that can be integrated in an X-ray system and that communicates to a workstation. Multiple DR detectors can communicate to a single MUSICA Acquisition Workstation. A DR detector can be used on more than one MUSICA Acquisition Workstation.

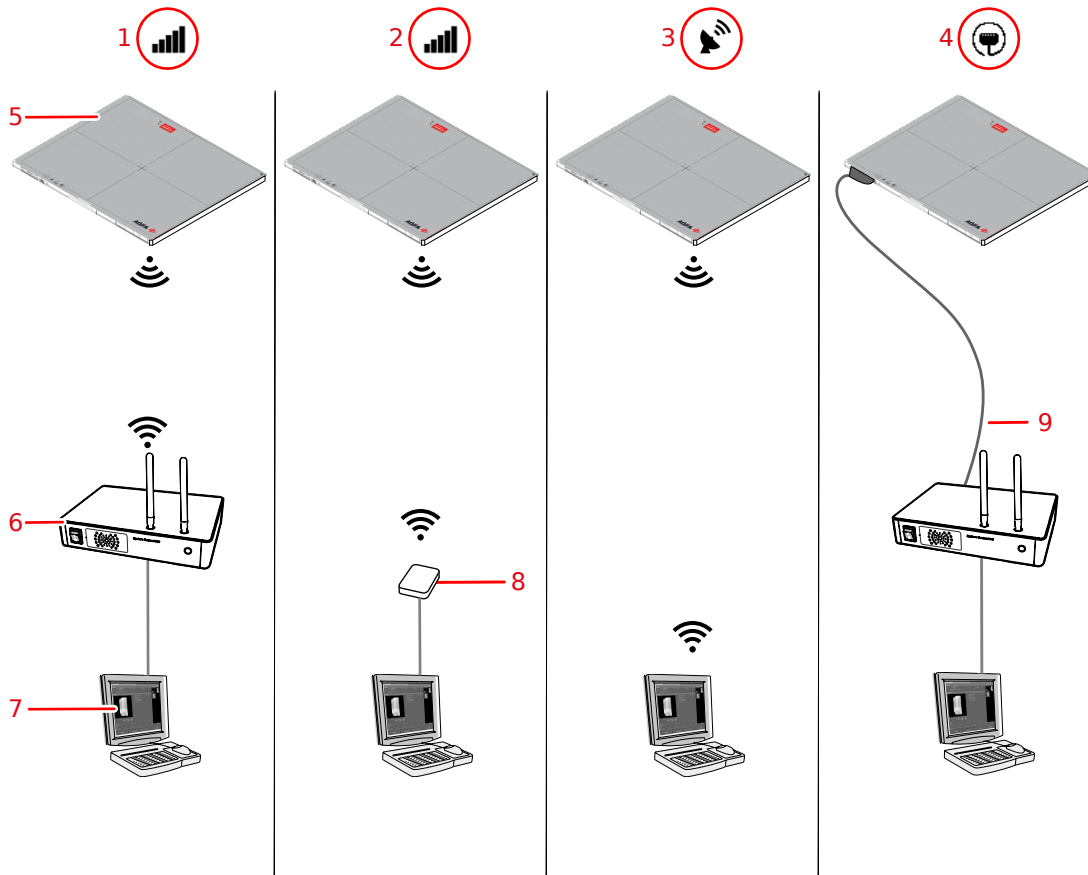

1. **Client mode:** the detector connects to the workstation via the built-in access point of the System Control Unit (SCU).
2. **Client mode:** the detector connects to the workstation via a wireless access point.
3. **Access point mode:** the workstation connects to the detector, which is acting as an access point.
4. **Wired mode:** the detector communicates to the workstation via the DR detector cable.
5. DR detector
6. System Control Unit (including a wireless access point)
7. Workstation
8. Wireless access point
9. DR detector cable

Figure 1: Configurations

A DR detector is during installation configured either in client mode or in access point mode.

Related information

[Managing network connections in client mode configuration](#) on page 97

[Managing network connections in access point mode configuration](#) on page 98

Equipment Classification

Per EN/IEC60601-1, Medical Electrical Equipment, General Requirements for Safety, the DR Detector, including the battery pack, is classified as following.

Type of protection against electrical shock	Internally powered (wireless configuration) Class I equipment (wired configuration)
Degree of protection against electrical shock	Type B applied parts
Degree of protection against ingress of water and dust	IP67 (degrees of protection against ingress of water and dust provided by enclosure)
Flammable anesthetics	This device is not suitable for use in the presence of a flammable anesthetic mixture with air, or in presence of a flammable anesthetic mixture with oxygen or nitrous oxide.
Operation	Continuous operation.
Applied Parts	The DR detector tube side is an applied part.
Expected service life	Up to seven (7) years (if regularly serviced and maintained according to Agfa instructions)

- [Non-medical equipment](#) on page 12

Non-medical equipment

Following components are classified as non-medical equipment:

- System Control Unit (SCU)
- DR detector charging stand
- DR detector battery charger
- Workstation

Options and Accessories

- DR detector charging stand
- DR detector battery
- Power adapter with USB Type-C cable
- DR detector battery charger
- Wireless power transmitter

The delivery contains a set of labels. When using multiple DR Detector, on the labels a nickname is written to identify the DR Detector. An identical label is attached to the bucky of the X-ray system to identify the dedicated workspace of each DR Detector.

- [Anti-scatter grids](#) on page 13

Anti-scatter grids

Anti-scatter grids are used to reduce scattered radiation and improve image quality. Grids are available as an option.

Refer to the Agfa website for specifications on the anti-scatter grids that have been found compatible with the system and the DR Detectors.

<http://www.agfahealthcare.com/global/en/library/overview.jsp?ID=54332498>

Operation Controls

- [XD 14, XD*14](#) on page 15
- [DR detector charging stand](#) on page 17
- [DR Detector dual battery charger](#) on page 18
- [System Control Unit](#) on page 19
- [System Control Unit Lite](#) on page 20
- [DR detector cable](#) on page 21
- [DR Detector Switch](#) on page 22

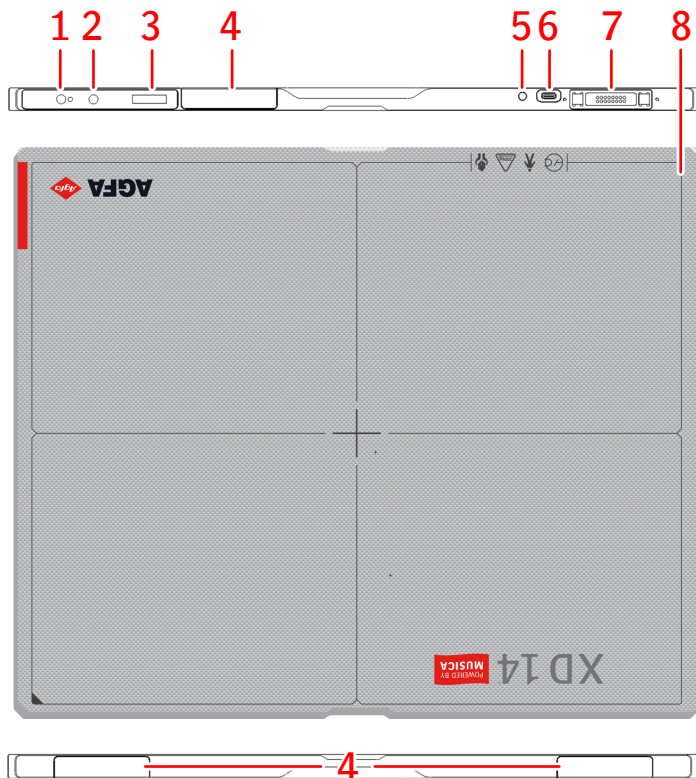
XD 14, XD*14

- 1.** Power button with indicator light
 - Press to start the DR detector or to display the status of the DR detector.
 - Press and hold for 3 seconds to stop the DR detector.
- 2.** **AP mode** button
 - Press to display the status of the DR detector.
 - Press and hold for 3 seconds to change the network connection.
- 3.** Status display
 - Battery status
 - Connection status
 - IP address
 - SSID name
- 4.** Antenna of the wireless network adapter
 - Operation in wireless configuration.
- 5.** Battery status indicator
- 6.** Connector for power adapter (USB Type-C)
- 7.** DR detector connector
 - Operation in wired configuration.
 - Charging the battery.
- 8.** Effective imaging area border and center position indication

Figure 2: DR detector operation controls

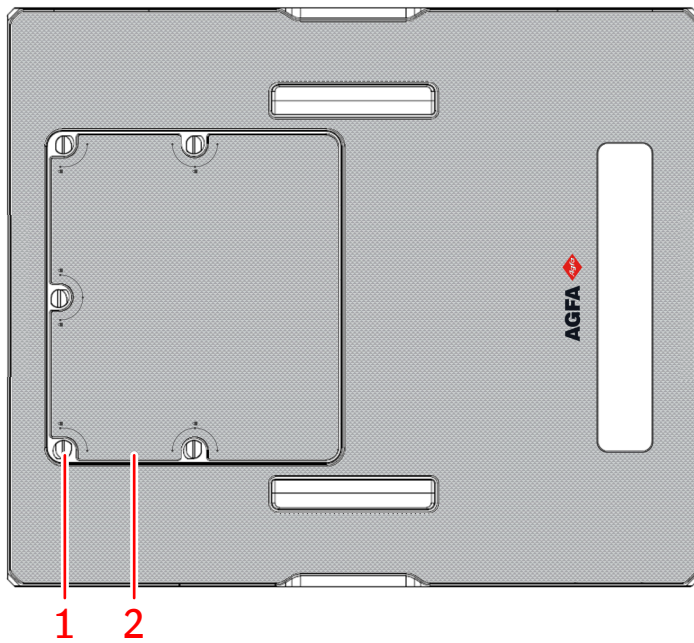

1. Knobs securing the battery cover plate.
2. Cover plate for the DR detector battery

The battery supplies power to the detector during wireless communication.

Figure 3: DR detector rear side

Related information

[Advanced Operating](#) on page 87

[XD 14, XD*14 technical data](#) on page 109

DR detector charging stand

The battery charging stand has two slots to insert a DR detector.

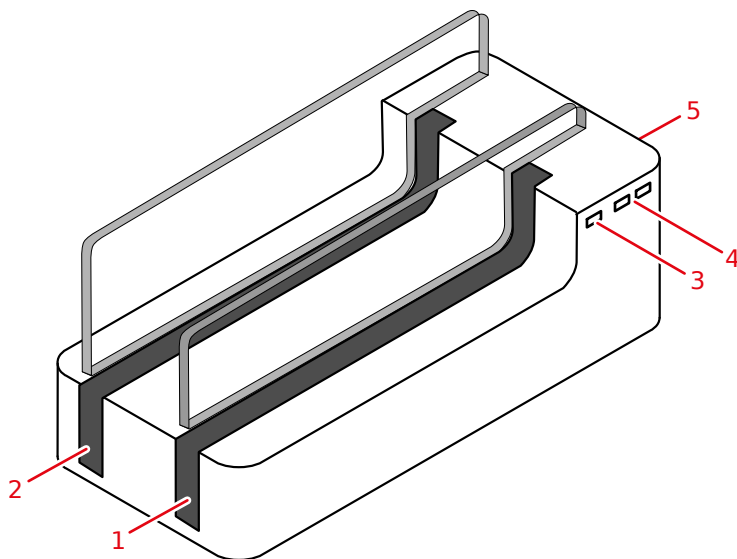

1. Slot A
2. Slot B
3. Power status indicator
4. Status indicators for slot A and slot B
 - Yellow to indicate that the battery is charging.
 - Green to indicate that the battery is fully charged.
5. At the rear side:
 - Power button
 - Connector for power adapter

Figure 4: DR detector charging stand



Warning: Do not use the DR detector charging stand within the patient's vicinity.

Related information

[Charging the DR detector in the DR detector charging stand](#) on page 92

[DR detector charging stand technical data](#) on page 112

[Safety directions for the power supply](#) on page 65

DR Detector dual battery charger

The dual battery charger is available depending on the configuration of the system.

The battery charger has two slots to insert a battery.

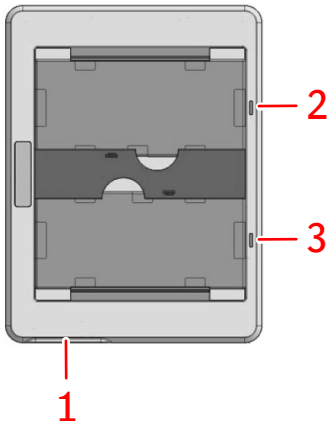

1. Connector for power adapter
 2. Status indicator of the top slot
 3. Status indicator of the bottom slot
- Orange to indicate that the battery is charging.
 - Green to indicate that the battery is fully charged.

Figure 5: DR detector battery charger



Warning: Do not use the battery charger within the patient's vicinity.

System Control Unit

The System Control Unit is connected to the DR Detector via wireless network or via the DR Detector cable.

The System Control Unit is connected to the X-ray generator to synchronize the exposure, in a configuration with X-ray generator synchronization.

The System Control Unit is connected to the workstation via wired network.

Depending on the configuration, the System Control Unit may not be part of the system.

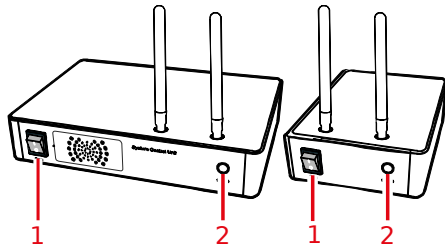

1. Power switch
2. Status indicator

- Blinking green: starting up
- Green: ready
- Blue: communicating to the detector

Figure 6: System Control Unit (SCU) and Mini System Control Unit (Mini SCU)



Warning: Do not use the System Control Unit within the patient's vicinity.

Related information

[System Control Unit](#) on page 114

[Mini System Control Unit](#) on page 115

[Safety directions for the System Control Unit](#) on page 66

[Safety directions for the power supply](#) on page 65

System Control Unit Lite

The System Control Unit Lite is connected to the DR Detector via the DR Detector cable.

The System Control Unit Lite is connected to the X-ray generator to synchronize the exposure, in a configuration with X-ray generator synchronization.

The System Control Unit Lite is connected to the workstation via wired network.

Depending on the configuration, the System Control Unit Lite may not be part of the system.

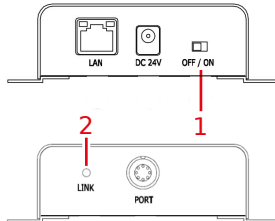

1. Power switch
2. Status indicator

- Green or orange: ready

Figure 7: System Control Unit Lite



Warning: Do not use the System Control Unit within the patient's vicinity.

Related information

[Safety directions for the power supply](#) on page 65

[System Control Unit Lite](#) on page 116

[Safety directions for the System Control Unit](#) on page 66

DR detector cable

The DR detector cable connects the DR detector to the System Control Unit.

The DR detector cable can be used for charging the battery of the DR detector, to power the DR detector and to transmit image data.

Related information

[Charging the battery using the DR detector cable](#) on page 94

[Wired communication](#) on page 33

DR Detector Switch

The **DR Detector Switch** is available in the title bar of the MUSICA Acquisition Workstation. The **DR Detector Switch** shows which DR detector is active and shows its status. The **DR Detector Switch** can be used to activate another DR detector.



Figure 8: DR Detector Switch

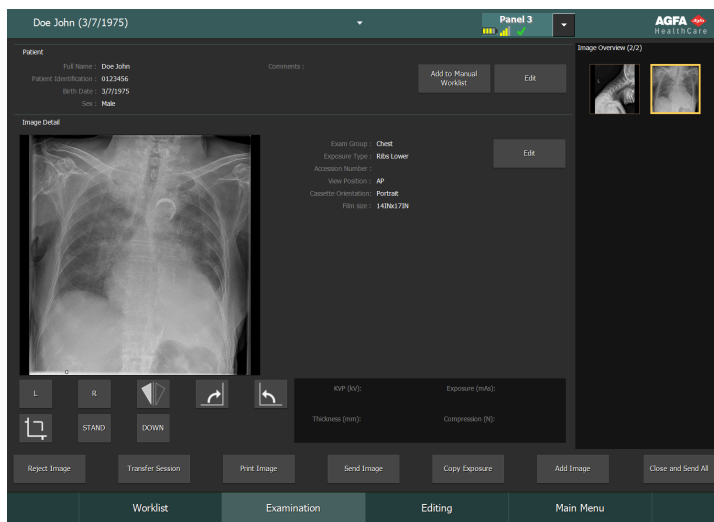

Figure 9: Title bar with DR Detector Switch

Battery status icon					(empty)
Meaning	Full	Medium	Low	Empty	Wired DR Detector Wireless DR detector is off or disconnected

Connection status icon (wifi/wired)					(empty)
Meaning	Good	Low	Bad	Wired DR detector	DR detector is off or disconnected

DR Detector status icon				(empty)
Meaning	DR detector is ready for exposure	DR detector is initializing for exposure	DR detector is off or disconnected or in error	DR detector is inactive (no thumbnail selected)

DR Detector exposure synchronization

Automatic exposure detection icon	A	(empty)
Meaning	The active DR Detector is using automatic exposure detection	The active DR Detector is using X-ray generator synchronization



Note Depending on the installed software version, the icon may not be displayed.

System Documentation

The documentation consists of a User manual (this document) and related documentation:

- MUSICA Acquisition Workstation user manual (document 4420).
- MUSICA Acquisition Workstation key user manual (document 4421).
- DR detector calibration key user manual (document 0134).
- DR system user documentation (if applicable).

The documentation shall be kept with the system for easy reference.

The most extensive configuration is described within this manual, including the maximum number of options and accessories. Not every function, option or accessory described may have been purchased or licensed on a particular piece of equipment.

Technical documentation is available in the product service documentation which is available from your local support organization.

The most recent version of this document is available on <https://www.agfa.com/he/global/en/internet/library>

- [Wireless access point](#) on page 24

Wireless access point

The wireless access point is delivered with its own user documentation.

Training

The user must have received adequate training on the safe and effective use of the system before attempting to work with it. Training requirements may vary from country to country. The user must make sure that training is received in accordance with local laws or regulations that have the force of law. Your local Agfa or dealer representative can provide further information on training.

The user must note the following information in the system documentation:

- Intended Use.
- Intended User.
- Safety Directions.

Product Complaints

Any health care professional (for example a customer or a user) who has any complaints or has experienced any dissatisfaction with the quality, durability, reliability, safety, effectiveness, or performance of this product must notify Agfa.

For a patient/user/third party in the European Union and in countries with identical regulatory regimes (Regulation 2017/745/EU on Medical Devices); if, during the use of this device or as a result of its use, a serious incident has occurred, please report it to the manufacturer and/or its authorised representative and to your national authority.

Contact address:

Agfa Service Support - local support addresses and phone numbers are listed on www.agfa.com

Agfa - Septestraat 27, 2640 Mortsel, Belgium

Agfa - Fax +32 3 444 7094

Compatibility

The system must only be used in combination with other equipment or components if these are expressly recognized by Agfa as compatible. A list of such equipment and components is available from Agfa service on request.

Changes or additions to the equipment must only be carried out by persons authorized to do so by Agfa. Such changes must comply with best engineering practice and all applicable laws and regulations that have the force of law within the jurisdiction of the hospital.

Compliance

- [General](#) on page 29
- [Safety](#) on page 29
- [Electromagnetic Compatibility](#) on page 29
- [Radio Frequency](#) on page 30

General

- The product has been designed in accordance with Regulation (EU) 2017/745 on medical devices (MDR)
- ISO 13485
- ISO 14971

Safety

- IEC 60601-1
- AAMI ES 60601-1
- CSA C 22.2 No.60601-1

Electromagnetic Compatibility

- IEC 60601-1-2

Radio Frequency

Declaration of conformity

U.S.A.	FCC Part 15.107(b) / Part 15.109(b) FCC Part 15 Subpart E 15.407 FCC Part 15 Subpart C 15.247
European Union (and EEA)	ETSI EN 301 489-1 V2.1.1 ETSI EN 301 489-17 V3.1.1 EN 300 328 V2.1.1 EN 301 893 V2.1.1
South Korea	KN 301 489-1 KN 301 489-17
Brazil	ANATEL This product contains the module WLE900VX 7AA000S-VW, ANATEL ID: 05379-20-05431

Related information

[Remarks for HF-emission and immunity](#) on page 116

Local regulations

This product complies with local radio frequency regulations in the country or region where you purchased the product. Note that it cannot be used in any areas other than the country or region of its purchase.

The radio frequency channel (5 GHz) configured for indoor use may not be usable in outdoor areas, depending on local radio frequency regulations.

If you would like to add other equipment to the environment where this product is installed, or to use this product in other environments, please consult your sales representative or local dealer for details.

Restrictions on outdoor use

There are restrictions on the outdoor use of the U-NII Low (5150-5250 MHz) and U-NII Mid (5250-5350 MHz) bandwidths of the WLAN module incorporated in the device in the following Member States: Belgium (BE), Bulgaria (BG), Czech Republic (CZ), Denmark (DK), Germany (DE), Estonia (EE), Ireland (IE), Greece (EL), Spain (ES), France (FR), Croatia (HR), Italy (IT), Cyprus (CY), Latvia (LV), Lithuania (LT), Luxembourg (LU), Hungary (HU), Malta (MT), Netherlands (NL), Austria (AT), Poland (PL), Portugal (PT), Romania (RO), Slovenia (SI), Slovakia (SK), Finland (FI), Sweden (SE) and United Kingdom (UK).

Specific absorption rate (SAR)



Warning: The SAR limit set by FCC is 2W/kg (for EU and Japan) and 1.6W/kg (for USA and Korea). This equipment complies with FCC&CE SAR regulation. The front side of a detector should be used for image acquisition.





- OET Bulletin 65, Supplement C (edition 01-01)
- EN 62311:2008
- EN 62209-2:2010

Connectivity

- [Wireless Communication](#) on page 32
- [Wired communication](#) on page 33

Wireless Communication

Wireless communication is established between the internal wireless module of the DR detector and the MUSICA Acquisition Workstation via the wireless access point. The DR detector is compliant with IEEE 802.11n/ac (2.4 GHz/5 GHz). The available frequency band varies depending on local radio laws and system requirements. The frequency band (channel) of the DR detector is selected at installation.

-  **Note** Use of multiple pieces of equipment that use the same frequency band (channel) may interfere with each wireless communication and cause a decline in transmission speed.
-  **Note** Before introducing other wireless equipment to the same environment where the DR detector is set up, consult the system engineer or qualified personnel at the medical site.
-  **Note** Do not place obstacles in the way of the wireless access point or of the antenna of the internal wireless module of the DR detector. Otherwise, the properties of wireless communication, such as the throughput and operable distance, may decrease.
-  **Note** Transmitting the image data to the MUSICA Acquisition Workstation takes a number of seconds. After making an exposure, stay with the detector in the direct neighbourhood of the wireless access point until the image is available on the MUSICA Acquisition Workstation.

Wireless communication in the bucky

If the DR detector is configured in access point mode, the properties of wireless communication, such as the throughput and operable distance, may decrease if the DR detector is in the bucky.

For applications using the bucky, it is strongly recommended to install an external access point.

Wired communication

The use of accessories and cables other than those specified or sold by the manufacturer as replacement parts, may result in increased radiation emissions or decreased stability of the equipment.

Accessory equipment connected to the analog and digital interfaces must be certified according to the respective IEC standards. All combinations of equipment must be in compliance with IEC 60601-1-1 system requirements.

Any person who connects additional equipment to the signal input or signal output ports, configures a medical system and is therefore responsible for ensuring that the system complies with the requirements of the system standard IEC 60601-1.

Installation

Installation and configuration is performed by an Agfa trained and authorized service engineer. Contact your local support organization for more information.

On a configuration with multiple DR detectors of the same type, it is required to apply labeling to the DR detector containing a unique nickname for each DR detector. The nicknames must be configured on the MUSICA Acquisition Workstation. The **DR Detector Switch** shows which DR detector is active and shows its status, by means of the nickname of the DR detector.

An identical label is attached to the bucky of the X-ray system to identify the dedicated workspace of each DR detector.

- [Environment of Use](#) on page 34

Environment of Use

The equipment is mainly for use in X-ray exposure rooms, hospital wards and mobile medical examination vehicles. To use it in other places, consult your sales representative or local Agfa dealer.



Warning: Do not install or store the equipment in any of the locations listed below. Doing so may result in failure or malfunction, equipment falling, or fire or injury:

- Close to facilities where water is used
- Where it will be exposed to direct sunlight
- Close to the air outlet of an air-conditioner or ventilation equipment
- Close to a heat source such as a heater
- Where the power supply is unstable
- In a dusty environment
- In a saline or sulfurous environment
- Where temperature or humidity is high
- Where there is freezing or condensation
- In areas prone to vibration
- On an incline or in an unstable area



Warning: This product may malfunction due to electromagnetic interference (EMI) caused by telecommunication devices, transceivers, electronic devices, etc. To prevent the electromagnetic wave from badly influencing the product, be sure to avoid placing it near the product. Or, change direction or position of the product or move into the shielded place to reduce electromagnetic interference.

Do not use the detector near devices generating a strong magnetic field. Doing so may produce image noise or artifacts.

Do not use this equipment in combination with peripherals such as defibrillators or large electric motors as these may cause power-supply noise or power supply voltage variations. Doing so may prevent normal operation of this equipment and peripherals.

Sudden heating of the room in cold areas will cause condensation to form on the equipment. In this case, wait until the condensation evaporates before use. If the equipment is used while condensation is formed on it, problems may occur. When an air-conditioner is used, be sure to raise/lower the temperature gradually so that a difference in temperature in the room and in the equipment does not occur, to prevent condensation.



Warning: Do not use non-medical equipment in the patient's vicinity.

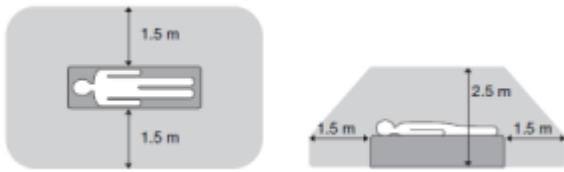

Figure 10: Patient's vicinity

Messages









Under certain conditions the DR detector shows a dialog box containing a message in the middle of the screen of the MUSICA Acquisition Workstation. This message informs the user that either a problem has occurred or that a requested action cannot be performed. The user must read these messages carefully. They will provide information on what to do from then on. This will be either performing an action to resolve the problem or to contact the local service organization. Details on the contents of messages can be found in the service documentation which is available to local service personnel.











Related information





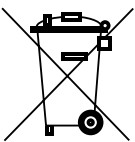

[Problem solving](#) on page 102

[Viewing the detector status](#) on page 88

Labels

Symbol	Explanation
	On (power: connection to the mains)
⊙	On (power: connection to the mains) for part of the equipment
○	Off (power: disconnection from the mains)
◊	Off (power: disconnection from the mains) for part of the equipment
	Tube side
	Direct current
	Alternating current
	Protective earth (ground)
	Equipotential connector: Provides a connection between the equipment and the potential bus bar of the electrical system as found in medical environments. It is recommended to use the equipotential connection as additional safety measure.
	Type B applied part
	Handle with care
	Maximum patient weight over the whole area of the detector surface
	Device contains a transmitter module that generates non-ionizing radiation.

Symbol	Explanation
	Manufacturer
	Date of manufacture
	Medical device
	Serial number
	This mark shows compliance of the equipment with Directive 93/42/EEC (for European Union).
	Indicates the authorized representative in the European Community
	This mark shows compliance with both Canadian and U.S. safety requirements. With respect to electric shock, fire, and mechanical hazards only.
	This mark shows compliance with both Canadian and U.S. safety requirements. With respect to electric shock, fire, and mechanical hazards only.
	FCC Declaration of Conformity label
	This symbol on the products, and/or accompanying documents means that used electrical and electronic products should not be treated as, or mixed with general household waste.
	This wheeled bin symbol on the products, and/or accompanying documents means that the used batteries should not be treated as, or mixed with general household waste.



Symbol	Explanation
	Medicine that can only be given by a prescription from a doctor or a doctor's recommendation to use a certain medicine. (for U.S.A. only)
	Read and understand all instructions and warning labels in the product documentation before using the equipment. Keep manual for future reference.
	Safety warning, indicating that the manuals should be consulted.
	General warning, caution, risk of danger.
	Dangerous voltage
	This mark shows the compliance with China RoHS for 10 years.
	General Mandatory action.

- [Additional labeling of the DR detector](#) on page 40
- [Additional labeling of the DR detector battery](#) on page 41
- [Additional labeling of the DR detector charging stand](#) on page 42
- [Additional labeling of the DR detector dual battery charger](#) on page 43
- [Additional Labeling of the System Control Unit](#) on page 44
- [Additional Labeling of the Mini System Control Unit](#) on page 45
- [Additional Labeling of the System Control Unit Lite](#) on page 46





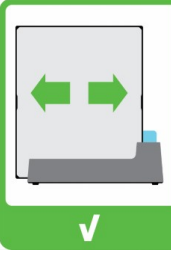
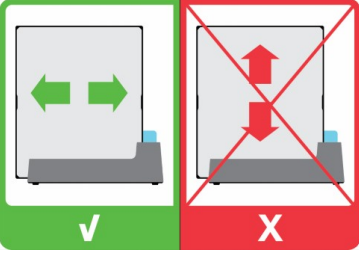

Additional labeling of the DR detector battery

	<p>Type label on the back side of the battery.</p>
---	--









Additional labeling of the DR detector charging stand

<p>VIVIX-S Detector Cradle</p> <p>Model No (240) : FXRR-01A SN (21) :</p> <p>Rating : 24V \approx Max. 6.66A</p> <p> Date of Manufacture (11) : RN :</p> <p></p> <p>CE 2460</p> <p>EC REP European Representative : Obelis s.a St. General Wehns 53 1030 Brussels, BELGIUM</p> <p> Manufacturer : VIEWWORKS Co., Ltd. • Headquarter : 41-3, Buriin-ro, 170beon-gil, Dongan-gu, Anyang-si, Gyeonggi-do, 14055 Republic of Korea • Hwaseong Site : 25-7, Jeongnamsaandan 2-gil, Jeongnam-myeon, Hwaseong-si, Gyeonggi-do, 18514 Republic of Korea MADE IN KOREA</p>	<p>Type label on the bottom side of the DR detector charging stand.</p>
<p></p> <p></p>	<p>Slide the detector horizontally into the charging stand. Inserting it vertically may damage the contact pins.</p>

Additional labeling of the DR detector dual battery charger







<p>VIVIX-S Battery Charger</p> <p>Model No (240) : FXRC-04A SN (21) :</p> <p>Rating : 24V \approx Max. 3.33A</p> <p> Date of Manufacture (11) : RN :</p> <p>    Electric Shock Choc Electrique </p> <p style="text-align: center;">CE</p> <p> Manufacturer : VIEWWORKS Co., Ltd. • Headquarter : 41-3, Bultin-ro, 170beon-gil, Dongan-gu, Anyang-si, Gyeonggi-do, 14055 Republic of Korea • Hwasong Site : 25-7, Jeongnamsandan 2-gil, Jeongnam-myeon, Hwasong-si, Gyeonggi-do, 18514 Republic of Korea MADE IN KOREA</p>	<p>Type label on the bottom side of the DR detector dual battery charger.</p>
---	---

Additional Labeling of the Mini System Control Unit

VIVIX-S System Control Unit	
Model No (210) : FXRS-04A SN (21) :	
Rating : 24V \approx Max. 2A	
	RN :
Date of Manufacture (11) :	
    	
	Electric Shock Choc Electrique
 MSIP-RMM-VJM FXRS-04A	
CE	
CMT ID : 2015A0634 FCC ID : PFRF3XRS04A 5.15-5.35GHz is indoor use only	
 F.NEX Manufacturer : VIEWWORKS Co., Ltd. • Headquarter : 41-3, Burm-ro, 170beon-gil, Dongan-gu, Anyang-si, Gyeonggi-do, 14055 Republic of Korea • Hwasong Site : 25-7, Jeongnamsandan 2-gil, Jeongnam-myeon, Hwasong-si, Gyeonggi-do, 18514 Republic of Korea MADE IN KOREA	

Type label on the bottom side of the Mini System Control Unit.

Additional Labeling of the System Control Unit Lite

<p>VIVIX-S System Control Unit</p> <p>Model No (240) : FXRP-02A SN (21) :</p> <p>Rating : 24V \approx Max. 1.0A</p> <p> Date of Manufacture (11) : RN :</p> <p>     Electric Shock Choc Electrique</p> <p>CE</p> <p> F:NEX Manufacturer : VIEWWORKS Co., Ltd. • Headquarter : 41-3, Burim-ro, 170beon-gil, Dongan-gu, Anyang-si, Gyeonggi-do, 14055 Republic of Korea • Hwaseong Site : 25-7, Jeongnamsandan 2-gil, Jeongnam-myeon, Hwaseong-si, Gyeonggi-do, 18514 Republic of Korea MADE IN KOREA</p>	<p>Type label on the bottom side of the System Control Unit Lite.</p>
--	---

Cleaning and Disinfecting

All appropriate policies and procedures should be followed to avoid contamination of the staff, patients and equipment. All existing universal precautions should be extended to avoid potential contaminations and to avoid patients coming into (close) contact with the device. The user is responsible for selecting a disinfection procedure.

- [Cleaning](#) on page 48
- [Use of protective plastic bag](#) on page 49
- [Disinfecting](#) on page 50
- [Approved disinfectants](#) on page 51
- [Safety directions for disinfection](#) on page 52

Cleaning

To clean the exterior of the equipment:

1. Stop the system



Warning: When the equipment is going to be cleaned, be sure to turn OFF the power of each device, and to unplug the power cord from the AC outlet. Never use anhydrous or high solvency alcohols, benzine, thinner or any other flammable cleaning agent. Otherwise, it may result in fire or electric shock.

2. Wipe the exterior of the system with a cloth slightly moistened with a neutral detergent. Some approved disinfectants can be used for cleaning as well.



Caution: Make sure no liquid gets in the device.



Caution: Clean the equipment with only a little moisture. Do not spray disinfectants or detergents directly on the equipment. Do not pour liquid directly on the equipment.



Caution: Liquids ingressing the DR Detector or the battery may cause malfunction and contamination. Take special care near the battery bay and near the cable connector on the side of the DR Detector.



Caution: Do not use abrasive brush and scraper to clean the product.



Note Do not open the equipment for cleaning. No components inside the device require cleaning by the user.

3. Start up the system.

Related information

[Approved disinfectants](#) on page 51

Use of protective plastic bag



Warning: Liquids ingressing the DR Detector may cause malfunction and contamination.

If there is a chance that the detector comes in contact with liquids (bodily fluids, disinfectants,...), the DR Detector must be wrapped in a protective plastic bag while performing the examination.

It is considered good clinical practice to use a single-use protective bag in all cases where contact of the device or contaminants is expected, to avoid contamination of others.

Make sure that the plastic bag is not wrinkled to avoid the creases showing in the image.

Disinfecting



Warning: To disinfect the device, use only disinfectants and disinfection methods that are approved by Agfa and that correspond to the national regulation and guidelines as well as explosion protection.

If you plan to use other disinfectants, approval of Agfa is needed before use, as most disinfectants can damage the device. UV disinfection is also not allowed.

Perform the procedure following the instructions for use, the disposal instructions and the safety instructions of the selected disinfectants and tools and of the hospital.









Items contaminated with blood or body fluids, which may contain blood-borne pathogens, should be cleaned and then receive intermediate level disinfection with a product having an EPA-registered claim for activity against hepatitis B.

Approved disinfectants

Refer to the Agfa website for specifications on the disinfectants that have been found compatible with the cover material of the device and can be used on the outer surface of the device.

<https://www.agfa.com/he/global/en/internet/library/overview.jsp?ID=41651138>

Safety directions for disinfection

-  **Warning:** When the equipment is going to be cleaned, be sure to turn OFF the power of each device, and to unplug the power cord from the AC outlet. Otherwise, it may result in fire or electric shock.
-  **Warning:** Do not pour liquid directly on the equipment. Always use a clean, low-linting cloth dampened (not dripping) with the solution.
-  **Warning:** Use in well-ventilated areas.
-  **Warning:** Do follow the instructions of use as provided with the cleaning or disinfection product.
-  **Warning:** Consult the manufacturer's Material Safety Data Sheets (MSDS) and recommendations on the product label for additional information prior to use.
-  **Caution:** Clean the equipment with only a little moisture. Do not spray disinfectants or detergents directly on the equipment. Do not pour liquid directly on the equipment.
-  **Caution:** Be sure that all surfaces are thoroughly dry before returning the equipment to use.
-  **Caution:** Make sure that the equipment is properly decontaminated and disinfected before shipment or servicing.

Maintenance

Always consult the Agfa Service documentation and an Agfa trained and authorized service engineer for complete maintenance schedules.

In order to ensure that the equipment is used safely and normally, be sure to inspect the equipment before use. If any problem is found during the inspection and cannot be corrected, please contact your sales representative or local dealer.

- [Daily inspection](#) on page 54
- [Half-yearly inspection](#) on page 55
- [Regular Inspection and Maintenance](#) on page 56
- [Replacement Parts Support](#) on page 57
- [Repair](#) on page 58

Daily inspection



Warning: For safety reasons, be sure to turn OFF the power to each piece of equipment before performing the following. Otherwise, an electric shock may result.

1. Ensure that cables are not damaged and cable jackets are not torn.
2. Ensure that the power cord plugs are securely connected to both the equipment AC inlet and the AC outlet.
3. Ensure that there are no loose screws or breaks.

Turn on the power. Start the MUSICA Acquisition Workstation and perform a test exposure.

Half-yearly inspection

To indicate when the half-yearly calibration is due, a message is displayed on the MUSICA Acquisition Workstation.

Perform calibration half-yearly or when exposure conditions have changed significantly. For details, refer to the DR Detector Calibration Key User Manual (0134).

Regular Inspection and Maintenance

In order to ensure the safety of patients, operating personnel and third parties, and to maintain the performance and reliability of the equipment, be sure to perform regular inspection at least once a year. Clean up the equipment, make adjustments, or replace consumables. There may be cases where overhaul is recommended depending on the conditions. Contact your sales representative or local dealer for regular inspections or maintenance.



Caution: Clean the plug of the power cord periodically by unplugging it from the AC outlet and removing dust or dirt from the plug, its periphery and AC outlet with a dry cloth. If the cord is kept plugged in for a long time in a dusty, humid or sooty place, dust around the plug will attract moisture. This could cause insulation failure resulting in a fire.



Caution: Do not perform maintenance and inspection while the equipment is used for a patient.

Replacement Parts Support

Parts required to maintain the functioning of the product will be stocked for seven years after discontinuance of production, to allow for repair.

Repair

The product can only be repaired in the factory.

Patient data security

The user must ensure that the patients' legal requirements are met and that the security of the patient data is guarded.

The user must define who can access patient data in which situations.

The user must have a strategy available on what to do with patient data in case of a disaster.

- [Requirements on the operating environment](#) on page 59

Requirements on the operating environment

These operating environment requirements for information security and privacy (ISP), set in compliance with point 17(4) and 18(8) of Annex I of the EU Medical Device Regulation 2017/745, must be implemented and used in connection with the use of the Agfa medical device by the Customer (User). These are minimum requirements and designed to protect against unauthorised access that could hamper the device from functioning as intended.

Although Agfa has defined these ISP Operating Environment Requirements for implementation by the Customer, Agfa makes no warranties, expressed or implied regarding those ISP Operating Environment Requirements.

Agfa disclaims all liability if a security incident would occur despite the implementation of these ISP Operating Environment Requirements by the Customer.

Agfa reserves the right to revise these ISP Operating Environment Requirements and to make changes to them at any time. Possible revisions of the ISP Operating Environment Requirements will only be available in an electronic form, on request, via our website, by using the user documentation request form <https://www.agfa.com/he/global/en/internet/library>.

The information presented herein is sensitive and is company confidential. Without written authority from Agfa, further distribution outside the company is not allowed.

- Perimeter firewalls shall be in place and appropriately configured in order to ensure that communications between medical devices and external resources are either denied or restricted to just the communications that are essential for the medical devices to properly function.
- Network Intrusion Detection/Prevention Systems (NIDS/NIPS) shall be in place at the perimeter and appropriately configured, in order to provide early warning of an attack attempt or successful compromise of a medical device as well as to attempt to prevent compromise of medical devices.
- A Network Time Protocol Server shall be configured in the medical devices in order to synchronize the time in the audit logs with the time on the NTP server.
- Medical devices shall be on an isolated network segment that restricts communication of the medical devices to the systems that are required for the device to function.
- Internal firewalls shall be put in place to improve upon network segmentation and to further restrict communications of medical devices to the systems (internal and external) that they need to interact with.
- Medical device configurations shall be backed up in a secure separate device.
- Security controls shall be put in place to ensure that physical access to medical devices is limited only to authorized individuals and that physical theft of the device is prohibited.
- An incident response plan detailing responsibilities and how to react and recover from incidents, shall be in place. Staff involved in the incident response plan shall be trained to respond appropriately and effectively.
- A formal user provisioning and de-provisioning process shall be implemented to enable the appropriate management of access rights to medical devices.
- Users shall be assigned unique accounts to medical devices.

- User access rights to medical devices shall be reviewed for appropriateness and corrected as needed, at regular intervals not exceeding once a year.

Environmental Protection

Disposal of this product in an unlawful manner may have a negative impact on health and on the environment. Therefore, when disposing of this product, be absolutely sure to follow the procedure which is in conformity with the laws and regulations applicable in your area.



Figure 11: WEEE end user information

The directive on Waste Electrical and Electronic Equipment (WEEE Directive 2012/19/EU) aims to prevent the generation of electric and electronic waste and to promote the reuse, recycling and other forms of recovery. It therefore requires the collection of WEEE, recovery and reuse or recycling.

Due to the implementation into national law, specific requirements can be different within the European Member States.

This symbol on the products, and/or accompanying documents means that used electrical and electronic products should not be treated as, or mixed with general household waste

For more detailed information about take-back and recycling of this product please contact your local Agfa service organization and/or Agfa dealer. By ensuring this product is disposed of correctly, you will help prevent potential negative consequences for the environment and human health, which could otherwise be caused by inappropriate waste handling of this product. The recycling of materials will help to conserve natural resources.

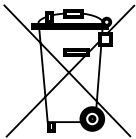

















Figure 12: Battery Notice

This wheeled bin symbol on the products, and/or accompanying documents means that the used batteries should not be treated as, or mixed with general household waste.

This wheeled bin symbol on batteries or its packaging may be used in combination with a chemical symbol. In cases where a chemical symbol is available it indicates the presence of respective chemical substances. If your equipment or replaced spare parts contain batteries or accumulators please dispose of them separately according to local regulations.

For battery replacements please contact your local sales organization.

Safety Directions

-  **Warning:** Safety is only guaranteed when an Agfa certified field service engineer has installed the product.
-  **Warning:** Improper changes, additions, maintenance or repair of the system can lead to personal injury, electrical shock and damage to the equipment. Safety is only guaranteed when changes, additions, maintenance or repairs are carried out by an Agfa certified field service engineer. A non certified engineer performing a modification or service intervention on a medical device, acts on his own responsibility and makes the warranty void.
-  **Warning:** Do not use or store the equipment near flammable chemicals such as alcohol, thinner, benzene, etc. If chemicals are spilled or evaporate, it may result in fire or electric shock through contact with electric parts inside the equipment. Also, some disinfectants are flammable. Take care when using them.
-  **Warning:** Do not connect the equipment with anything other than specified. Doing so may result in fire or electric shock.
-  **Warning:** Never disassemble or modify the equipment. Doing so may result in fire or electric shock. Also, since the equipment incorporates parts that may cause electric shock as well as other hazardous parts, touching them may cause death or serious injury.
-  **Warning:** Never modify the cables. Doing so may damage them and result in fire or electric shock.
-  **Warning:** Never remove or modify files on the workstation that are associated to the equipment software. Only use the tools provided with the product.
-  **Warning:** Do not place any objects on top of the equipment. The object may fall and cause an injury. Also, if metal objects such as needles, staples or clips fall into the equipment, or if liquid is spilled, it may result in fire or electric shock. If liquid or water flows into an electrical component, turn off the power, mark it as "Out of Order" and contact service.
-  **Warning:** Do not hit or drop the equipment. The equipment may be damaged if it receives a strong jolt, which may result in fire or electric shock if the equipment is used without being repaired.
-  **Warning:** If an X-ray image is taken while the patient is moving, the quality of the image may be affected. Make sure that the patient maintains a fixed posture as much as possible.
-  **Warning:** To avoid electric shocks and burns caused by use of the wrong type of fire extinguisher, make sure that the fire extinguisher at the site has been approved for use on electrical fires.
-  **Caution:** Strictly observe all warnings, cautions, notes and safety markings within this document and on the product.
-  **Caution:** All Agfa medical products must be used by trained and qualified personnel.
-  **Caution:** This device is not intended to supply heat to a patient. However, during normal use, surfaces will become heated due to power dissipation. Patient contact surfaces will not exceed 48 °C under normal use conditions. The operator should monitor and evaluate how much of the patient's body area is in contact with these surfaces and for how long.
-  Operating the detector in an environment at maximum ambient temperature (40 °C) can make temperatures exceed 41 °C (45.6 °C highest recorded) on a patient-applied part (the front side of the detector). It is up to the operator to determine if this temperature is too high based upon the condition of the patient and, if so, to ensure the ambient temperature of the environment is 35 °C or below. Normally, the detector can be used safely if the patient contact time on the front side of the detector is less than 10 minutes. If the ambient temperature

is higher than 35 °C and the patient contact time is more than 10 minutes, the thermal energy on the detector surface can sometimes have a detrimental effect on the patient. Therefore, in this case, the ambient temperature should be lowered to 35 °C or below.

 **Caution:** Excessive ambient temperature may impact performance of DR Detectors and cause permanent damage to the equipment. If ambient temperature and humidity is outside the range of 0 - 40 °C and 5 - 90% RH, do not operate the system or use air conditioning. Warranty will be void if it is obvious that operating conditions are not met.

 **Caution:** Turn OFF the power to each piece of equipment for safety when not being used.

 **Caution:** Handle the equipment carefully. Do not submerge the equipment in water. The internal image sensor may be damaged if something hits against it, or if it is dropped, or receives a strong jolt.

 **Caution:**
Do not place excessive weight on the detector. Avoid the whole weight of the patient body to rest on the detector. Otherwise, the internal image sensor may be damaged. Load limit - Uniform load: 400 kg over the whole area of the detector surface. Load limit - Local load: 200 kg on an area 40 mm in diameter.

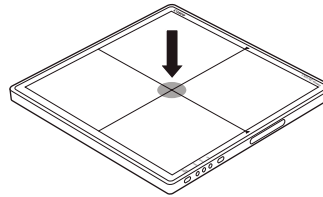
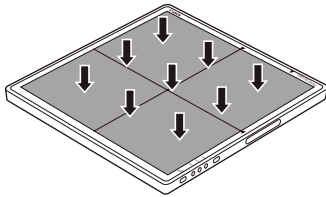

 **Caution:** Be sure to use the detector on a flat and rigid surface so it will not bend. Otherwise, the internal image sensor may be damaged. Be sure to securely hold the detector while using it in upright positions. Otherwise, the detector may fall over, resulting in injury to the user or patient, or may flip over, resulting in damage to the inner device.

 **Caution:**
If a malfunction occurs, do not use this device until qualified personnel correct the problem. Should any of the following occur, immediately turn OFF the power to each piece of equipment, unplug the power cord from the AC outlet, and contact your sales representative or local dealer:

- When there is smoke, an odd smell or abnormal sound
- When liquid has been spilled into the equipment or a metal object has entered through an opening
- When the equipment has been dropped and is damaged

 **Caution:** Observe great care when handling the DR Detector. The detector is shock sensitive and drops should be avoided. Warranty will be void if it is obvious that operating conditions are not met.













 If the DR Detector has been dropped:

1. Visually check the DR Detector for deformations.
2. Perform a calibration of the DR Detector. For instructions, refer to the *DX-D DR Detector Calibration Key User Manual (document 0134)*.
3. Perform a flat field exposure and check the image for visible artifacts. Typical flat field exposure settings are 75 kV, 10 μ Gy, large focus and using 1.5 mm Cu filter without grid.

 **Warning:** Damaged grid. Reduced image quality. Please handle the grids with special care.

- [Safety directions for the power supply](#) on page 65
- [Safety directions for the System Control Unit](#) on page 66
- [Safety directions for the DR detector battery](#) on page 67

Safety directions for the power supply

-  **Warning:** Do not operate the equipment using any type of power supply other than the one indicated on the rating label. Otherwise, it may result in fire or electric shock.
-  **Warning:** Do not use any power cords other than the one provided with this equipment. Otherwise, it may result in fire or electric shock.
-  **Warning:** To avoid risk of electric shock, this equipment must only be connected to a supply mains with protective earth. Make sure that all components of the system are connected to a common earth point.
-  **Warning:** Do not handle the equipment with wet hands. You may experience an electric shock that could result in death or serious injury.
-  **Warning:** Do not place heavy objects such as medical equipment on cables and cords, or do not pull, bend, bundle or step on them to prevent their sheath from being damaged, and do not alter them neither. Doing so may result in fire or electric shock.
-  **Warning:** Do not supply power to more than one piece of equipment using the same AC outlet. Doing so may result in fire or electric shock.
-  **Warning:** Do not connect a multiple portable socket-outlet or extension cord to the system. Doing so may result in a fire or electric shock.
-  **Warning:** Securely plug the power cord into the AC outlet. If contact failure occurs, or if dust or metal objects come into contact with the exposed metal prongs of the plug, fire or electric shock may result.
-  **Warning:** Be sure to turn off the power to each piece of equipment before connecting or disconnecting the cords. Otherwise, you may get an electric shock that could result in death or serious injury.
-  **Warning:** Do not connect the AC or DC power cable to the product with the power applied. Failure to do so may result in damage to the product.
-  **Warning:** Be sure to hold the plug or connector to unplug the power cord. If you pull the power cord, the core wire may be damaged, resulting in fire or electric shock.
-  **Warning:** When using the power supply, care must be taken to ensure that there is either a mains plug or an all-cable disconnecting device in the internal installation fitted near the device and that it is easily accessible in case of emergency.
-  **Caution:** Position the power supply so that it is possible to disconnect it from the mains power if required.

Safety directions for the System Control Unit



Warning: Do not block the ventilation ports to prevent overheating. Overheating can cause system malfunction and damages.



Warning: Ensure continuous power supply to the system, with voltage and current according to the product specifications. If power failures are frequent, an uninterrupted power supply (UPS) should be installed to avoid loss of data.



Caution: The System Control Unit and the X-ray generator must be grounded to a common protective earth. Always connect the three-core power cord plug to a grounded AC power outlet.

Safety directions for the DR detector battery



Warning:

Keep the battery pack at room temperature (20±5°C).

Keep the battery pack in dry condition.

The remaining battery level should be 20% to 60% when not in use for a long time.

Charging stops once the battery is fully charged, and it is safe to keep the battery in the charger or detector. It does not have any impact on battery life.

Do not use any means for charging the battery other than that specifically provided for use with the equipment.

The battery is used with the DR Detector. Do not use them in other combinations.

Use only a power adapter complying with IEC 60601-1, IEC 60950-1 or IEC 62368-1.

Make sure to turn off the detector before detaching a battery pack.

When replacing the battery, only use batteries that are designated for the Agfa DR detectors. If you use a battery other than the specified one, the battery may explode, or electrolyte may spill out, resulting in a fire or electrical shock.

When the detector is not to be used for some time, remove the battery pack. Otherwise, over discharge may occur resulting in the shortened battery life.

Securely plug the power cord of the charger into the AC outlet. If contact failure occurs, or if dust/metal objects come into contact with the exposed metal prongs of the plug, fire or electric shock may result.

Always check the remaining amount of the battery pack during use of the detector. If performance of the battery pack has some problems, consult your local Agfa representative.

The battery charger is designed for the dedicated battery pack. Do not use the battery charger other than the dedicated one. Otherwise, a battery explosion or a battery leak may occur, resulting in fire or electrical shock.

Do not operate the battery charger using any type of power supply other than the one indicated on the rating label.

Do not handle the product with wet hands.

Do not attempt to disassemble, alter, or apply heat to the product.

Avoid dropping or subjecting the product to severe impacts. To avoid the risk of injury, do not touch the internal parts of the battery if it has been cracked or otherwise damaged.

Stop using the battery pack immediately if it emits smoke, a strange smell, or otherwise behaves abnormally.

Do not let the battery pack and battery charger come into contact with water or other liquids and do not allow them to get wet.

Do not clean with substances containing organic solvents such as alcohol, benzene, thinner, or other chemicals. Otherwise, fire or electrical shock may result.

Do not allow dirt or metal objects (such as hair pins, clips, staples or keys) to contact the terminals. Otherwise, battery explosion or leakage of electrolyte may occur, resulting in fire, injury or pollution of surrounding area. If the battery leaks and the electrolytes come into contact with your eyes, mouth, skin or clothing, immediately wash it away with running water and seek medical attention.

Do not leave, store, or place the product in a location near heat sources, or in a place subject to direct sunlight, high temperature, high humidity, excessive dust, or mechanical shock.

Otherwise, battery leakage, overheating or damage to the product may occur, resulting in electrical shock, burns, injury or fire.

If the battery pack becomes heated or swollen, immediately replace the battery with a new one before using it. Otherwise, overheat, smoke, explosion, or fire may occur.

The Lithium ion/polymer battery is recyclable.

Battery slowly discharges even if not in use. The battery pack is a consumable item. If a fully charged battery is consumed quickly, use a new and fully charged battery pack.

Be sure to charge the battery periodically (once a year) if it is not used for an extended period of time. The battery pack cannot be charged if it has been over discharged.

Before discarding the battery pack, cover the terminals with adhesive tape or other insulators. Contact with other metal materials may cause fire or explosion.

Getting started

- [Starting the DR detector](#) on page 69
- [Basic Workflow DR Detector](#) on page 71
- [Offline image acquisition workflow](#) on page 80
- [Guidelines for Pediatric Applications](#) on page 83
- [Stopping the DR detector](#) on page 84
- [Automatic exposure detection](#) on page 85
- [Attaching the handle unit with anti-scatter grid](#) on page 86
- [Attaching the handle unit without anti-scatter grid](#) on page 87

Starting the DR detector

To start the DR detector:

1. If the DR detector is connected to the System Control Unit via the DR detector cable, check if the power cable of the System Control Unit is connected to the mains power.
2. Turn on the System Control Unit using the power switch.

The status indicator is green.

Skip to step 6.

Depending on the configuration, the System Control Unit may not be part of the system.

3. Fully charge the DR detector.

Charge the DR detector on the day of examination or on the previous day.

✔ **Note** The battery slowly discharges even if not in use. The battery pack may have expired if it discharges immediately after being fully charged. You can purchase a new battery pack to replace an exhausted one.

4. Take the DR detector out of the charging stand.

⚠ **Warning:** When taking the DR detector out of the charging stand by lifting it upwards, shock may be applied to the detector. Always take the DR detector out of the charging stand by pulling it forward.

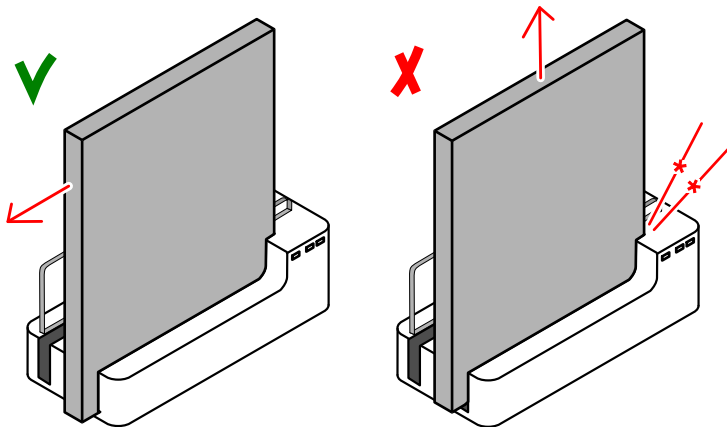

Figure 13: Pull the DR detector forward to take it out of the charging stand

5. Turn on the detector.

✔ **Note** Before operating the detector, start up the MUSICA Acquisition Workstation.

Press and hold the power button for 1 second.



Figure 14: Power button

During startup the power indicator is blinking green. After startup the power indicator is green.

6. Check the DR detector status icon on the **DR Detector Switch**.

If the displayed status is error, following step is required:

- If the DR detector is configured in client mode and the displayed status is error, connect the DR detector to the MUSICA Acquisition Workstation.
- If the DR detector is configured in access point mode, use the Windows wifi setting to connect the MUSICA Acquisition Workstation to the wireless network of the DR detector.

The DR detector is ready.

Before exposure make sure to check the equipment daily and confirm that it works properly.

Related information

[Viewing the detector status](#) on page 88

[Managing network connections in client mode configuration](#) on page 97

[Managing network connections in access point mode configuration](#) on page 98

[DR detector not ready for exposure](#) on page 104

Basic Workflow DR Detector

- [Step 1: retrieve the patient info](#) on page 72
- [Step 2: select the exposure](#) on page 72
- [Step 3: prepare the exposure](#) on page 73
- [Step 4: check the exposure settings](#) on page 74
- [Step 5: execute the exposure](#) on page 75
- [Step 6: perform a quality control](#) on page 76
- [Positioning the XD 14, XD*14](#) on page 77

Step 1: retrieve the patient info

At the MUSICA Acquisition Workstation:

1. When a new patient comes in, define the patient info for the exam.
2. Start the exam.

If the workstation is connected to a second monitor that is positioned outside the operator room, make sure that the patient data is not exposed to unauthorized persons.

Step 2: select the exposure

1. At the MUSICA Acquisition Workstation, select the thumbnail for the exposure in the **Image Overview** pane of the **Examination** window.

The selected DR detector is activated.

The **DR Detector Switch** shows the active DR detector and shows its status.

- Flashing: starting up
 - Green (constant): ready for exposure
2. At the X-ray generator console, select the exposure settings suitable for the exposure.

Step 3: prepare the exposure

In the examination room:

1. Position the DR Detector.

When using the bucky, check that the identification labels on the DR Detector and on the bucky match. Do not use a DR Detector that is dedicated to another bucky.

2. Position the patient.

Apply radiation protective measures for the patient if needed.

3. Check if the X-Ray system position is suitable for the exposure.

4. Position the X-Ray tube with respect to the DR Detector and the patient.

5. Set the correct distance between DR Detector and X-Ray tube.

6. Switch on the light on the collimator. Adapt collimation if required.

Take care that the collimated area is not larger than the detector.



Warning: Monitor the patient position (hands, feet, fingers, etc.) with special care to avoid injury to the patient caused by unit movements. Patient hands must be kept away from mobile components of the unit. Intravenous tubing, catheters and other patient connected lines should be routed away from moving equipment.

Step 4: check the exposure settings

On the DR Detector Switch:

1. Check if the DR Detector Switch displays the name of the DR Detector that's being used
2. If a wrong DR Detector is displayed, select the right DR Detector by clicking the drop down arrow on the DR Detector Switch.
3. Check the DR Detector Status icon.

On the X-ray system:

1. Check if the exposure settings displayed on the console are suitable for the exposure.
2. Check if no error messages are displayed on the X-ray system.

Exposure synchronization

Depending on the configuration, the DR Detector synchronizes to the exposure using one of these methods:

- X-ray generator synchronization
- Automatic exposure detection



Warning: In a configuration using automatic exposure detection, the X-ray system allows executing an exposure, even if the DR Detector is not ready. Avoid unnecessary dose by checking the status of the DR Detector before exposure. The DR Detector Switch displays the DR Detector status icon.

Related information

[Automatic exposure detection](#) on page 85

Step 5: execute the exposure

Press the exposure button to execute the exposure.



Make sure the generator is ready for exposure before you press the exposure button.



Warning: The radiation indicator on the control console lights up during exposure release.



Warning: Do not select another thumbnail until the preview image is visible in the active thumbnail.

At the MUSICA Acquisition Workstation:

- The image is acquired from the DR detector and displayed in the thumbnail.
- If collimation is applied, the image is automatically cropped at the collimation borders.

Step 6: perform a quality control

At the MUSICA Acquisition Workstation:

1. Select the image on which quality control is to be performed.
2. Prepare the image for diagnosis by using e.g. L/R markers or annotations.
3. If the image is OK, send the image to a hardcopy printer and/or PACS (Picture Archiving and Communication System).

Connecting the MUSICA Acquisition Workstation to the hospital network

If the DR detector is configured in access point mode, use the Windows wifi setting to connect the MUSICA Acquisition Workstation to the hospital network, to send images to the printer or to the PACS archive.

Related information

[Switching between the wireless DR detector and the wireless hospital network](#) on page 99

Positioning the XD 14, XD*14

Warning: Because the equipment cable is long, take care that cables do not become tangled during use. Also, be careful not to get your feet caught in the cable. It may cause a malfunction of the equipment or injury to the user from tripping over the cable.

Caution: Take care not to bend or wind the cable too tightly. Otherwise, the cable may be damaged, causing fire or electric shock.

When performing an exposure, keep in mind the following detector orientation aids:

- tube side
- patient orientation marker

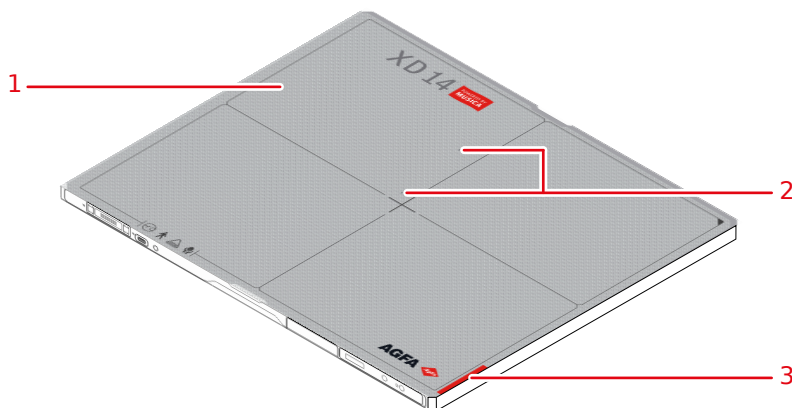

Figure 15: Detector orientation aids

1. Tube side of the detector
2. Position of the sensor for automatic exposure detection
3. Location of the patient orientation marker

The detector must be positioned with the patient orientation marker at the lower side of the region of interest.

The detector orientation and the patient orientation are exposure settings on the MUSICA Acquisition Workstation. The detector orientation is displayed on the MUSICA Acquisition Workstation as cassette orientation.

The user is responsible for the correct and clear marking on the left or right side of the image to eliminate possible errors.

Below some examples to illustrate the importance of the detector orientation marker.

Table 1: Skull AP portrait

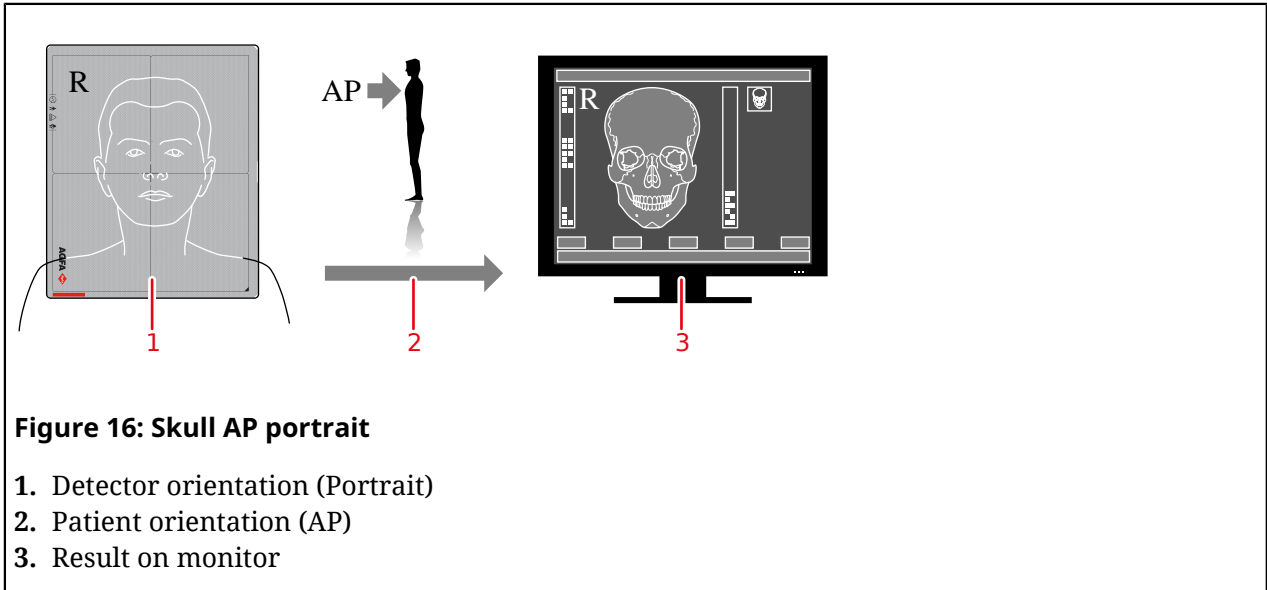

Table 2: Chest PA Landscape

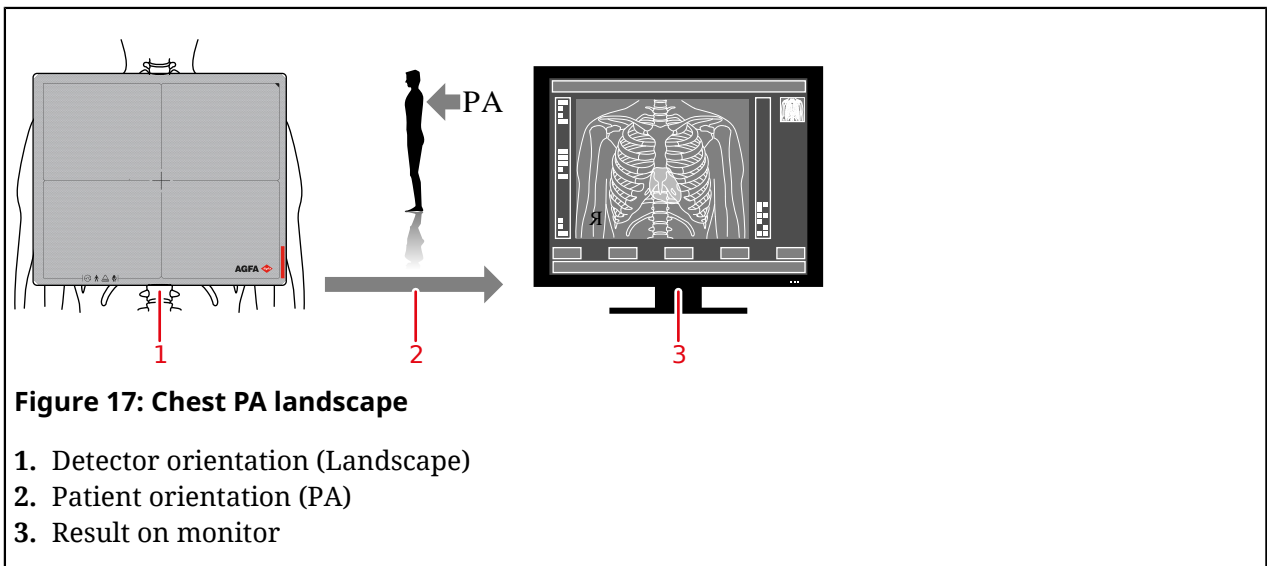

Table 3: Table with bucky

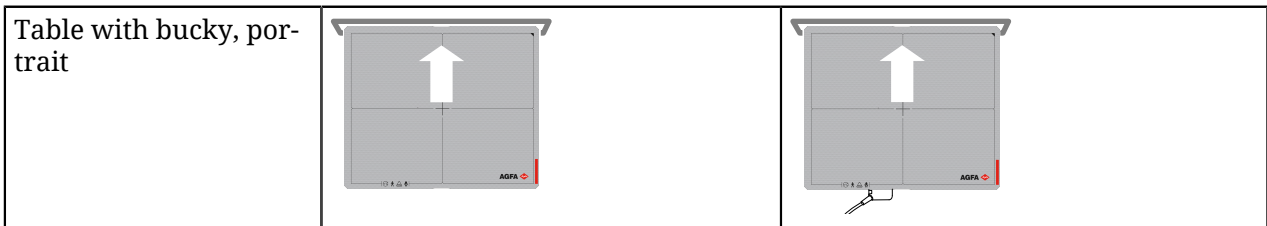
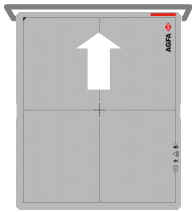
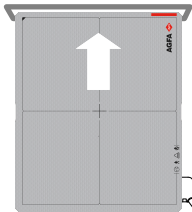
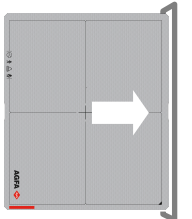
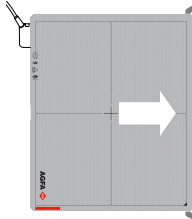
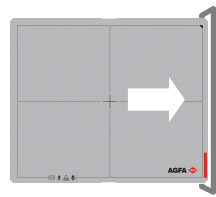
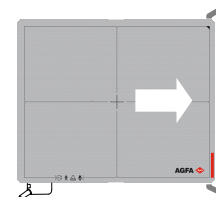
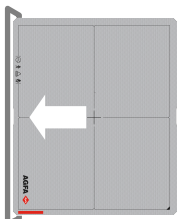
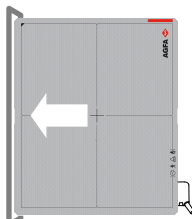
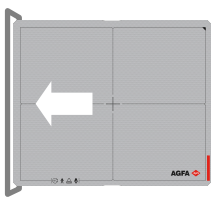
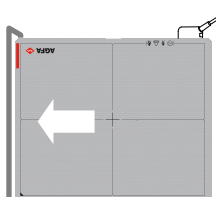

Table with bucky, landscape		
-----------------------------	---	--

The MUSICA Acquisition Workstation is configured for a specific patient orientation, either head left (default) or head right.

Table 4: Wallstand bucky

Wallstand with left loading bucky, portrait		
Wallstand with left loading bucky, landscape		
Wallstand with right loading bucky, portrait		
Wallstand with right loading bucky, landscape		

Depending on the design of the bucky, the wired configuration may not support the use of the DR Detector in the bucky.

Offline image acquisition workflow

A prerequisite for the offline image acquisition workflow is that the DR detector is configured to use automatic exposure detection.

The offline image acquisition workflow is only intended for DR detectors that are used in a DR Retrofit solution.

The DR detector can acquire multiple images without being connected to the MUSICA Acquisition Workstation. After reconnecting the DR detector, the images are uploaded to the MUSICA Acquisition Workstation and become available as recovery examinations, processed using a default exposure type. The patient data and image details of the images must be edited manually and the images must be transferred to the right patient.



Warning: Maximum 200 images can be stored on the DR detector during this workflow. Making more exposures will cause the first images to be deleted from the DR detector.



Warning: The user has to write down the demographic data and exposure timestamp for each image. The user is responsible for assigning the right images to the right patient after finishing the offline image acquisition workflow.



Warning: Do not turn off the DR detector during the offline image acquisition workflow. If the detector is turned off, reconnect it to the MUSICA Acquisition Workstation. The images that were already acquired will be downloaded. To acquire new images offline, restart the workflow.



Warning: On NX software with version "Type 22.--" or older, the timestamp on the recovery images does not contain the time when the image was acquired, so it cannot be used to identify the images. An alternative solution is to use lead markers that make the acquisition time or the patient identification visible in the image. Open **About NX** in the **Main Menu** to view the version number.

To acquire images offline:

1. Start a new examination.

This examination will contain only the first of the images that are acquired offline. The other images will each arrive in a separate recovery examination.

If the patient data for the first image are known, they can be filled in, otherwise, leave the patient data blank.

2. Add a thumbnail for the offline workflow to the examination.

The special exam type for offline imaging must be preconfigured on the MUSICA Acquisition Workstation.

- a) In the **Examination** window, click **Add Image**.

The **Add Image** window appears.

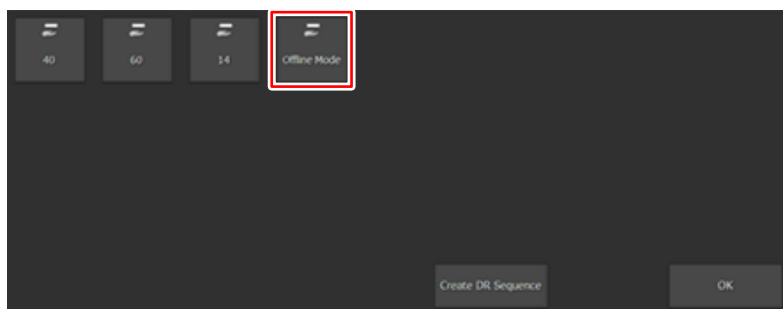

Figure 18: Offline Mode exam type

b) Select the exam type named **Offline Mode** and click **OK**.

The offline imaging thumbnail is added to the **Image Overview** pane.

3. Select the new thumbnail in the **Image Overview** pane.

A message is displayed to warn that the acquired images do not contain patient data and exam type, and to instruct that extra measures must be taken to avoid patient mix-up.

The selected DR detector is activated and set up for offline imaging.

4. Take the DR detector to the location where the image acquisition is performed.

The network connection between the DR detector and the MUSICA Acquisition Workstation is lost.

5. Perform the exposures using the DR detector.

Wait at least 15 seconds between exposures. The detector status display shows "**Send image**" while the detector is busy saving the acquired image.

The images are stored on the DR detector.

For each image, write down the patient identification and the relevant image details (exposure type, view position, image laterality,...), together with the timestamp when the exposure was made. After completing the workflow, the images will be identified using this timestamp.

To keep the images from different patients apart, you can e.g. use lead markers or make an empty exposure between patients.

6. Return the DR detector to the MUSICA Acquisition Workstation.

If the DR detector is configured for client mode, the network connection is automatically re-stored.

If the DR detector is configured for access point mode, use the Windows wifi setting to connect the MUSICA Acquisition Workstation to the wireless network of the DR detector.

The images are downloaded from the DR detector.

A message is displayed.

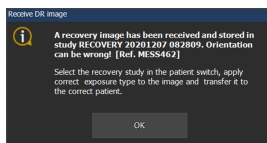

Figure 19: A recovery image has been received

- The first image is stored on the thumbnail of the original examination.
- The other images are stored in recovery examinations. They are listed in the **Worklist** window and in the drop-down list in the title bar.



Warning: A default image processing is applied, which may not be optimal for the acquired images. Exposure type, view position and image laterality are unknown while processing the image and thus not taken into account.

7. Perform following steps for each image, starting with the first image, that is available in the **Offline Mode** exam, and then the subsequent images in the recovery exams.

8. Double click the examination in the worklist or select it from the drop-down list in the title bar. Sort the **Worklist** by patient name to see the examinations in chronological order.

The image is opened in the **Examination** window.

9. Click the **Edit** button in the **Image Detail** pane to apply the correct image settings.

Check the notes that were made while acquiring the offline images to apply the correct image settings.

10.Assign the image to the right patient.

Check the notes that were made while acquiring the offline images to match the image to the right patient.

- If patient data is entered manually and this is the first image in the offline workflow for the current patient, click the **Edit** button in the **Patient** pane and fill in the correct patient data.
- In the other case, transfer the image to the examination with the correct patient data.

a. Return to the **Worklist** window.

Make sure not to select another exam!

b. Click **Transfer Images**.

The Transfer Images wizard opens.

c. In the **Image Overview** pane, select the image.

The image is displayed in the wizard.

d. Click **Continue**.

e. In the **Worklist** window, select the examination with the correct patient data.

The patient data is displayed in the wizard.

f. Click **Continue**.

A transfer overview is displayed to check if all information is correct.

g. Click **Finish**.

The recovery image is transferred to the examination.

11.Repeat steps 8 to 10, until all recovery images are assigned to the right patient and have the correct image settings applied.**12.**Clean up the empty recovery examinations.

Repeat following steps for all remaining empty recovery examinations.

a) Double click an empty recovery examination in the worklist or select it from the drop-down list in the title bar.

The **Add Image** window appears.

b) Click **OK**.

c) Click **Close and Send All**.

13.Close the examinations that contain the acquired images.

Open the examinations one by one. Perform quality control. If all images in the examination are OK, click **Close and Send All**.

Recovery examinations appear as open examinations. If the maximum number of open examinations is exceeded, transferring a recovery image to a worklist entry will fail. To solve this, first close the recovery examinations (click **Close and Send All** in the Examination window). The examinations can now be opened one by one from the **Closed Exams** list.

Depending on the configuration, editing patient data may be prohibited. If patient data is not available from the RIS, manually create new examinations in the worklist for each patient, into which the images from the offline workflow can be transferred.

The DR detector is still set up for offline imaging. If an exposure is made, a new recovery image may arrive. To end offline imaging, open an examination with an empty thumbnail that is configured for that detector and click the thumbnail.

Guidelines for Pediatric Applications



Caution: Use special care when imaging patients outside the typical adult size range. Children are more radiosensitive than adults.

Reducing dose for radiographic procedures while maintaining acceptable clinical image quality will benefit patients.

Adopting the Image Gently campaign guidelines and reducing dose for radiographic procedures while maintaining acceptable clinical image quality will benefit patients. Please review the following link and reduce pediatric technique factors accordingly: <http://www.imagegently.org>

As a general rule, next recommendations shall be observed in pediatrics:

- X-Ray Generator must have short exposures times.
- AEC must be used carefully, preferably use manual technique setting, applying lower doses.
- If possible, use high kVp techniques.

Positioning the pediatric patient: Pediatric patients are not as likely as adults to understand the need to remain still during the procedure. Therefore it makes sense to provide aids to maintaining stable positioning. It is strongly recommended the use of immobilizing devices such as bean bags and restraint systems (foam wedges, adhesive tapes, etc.) to avoid the need of repeating exposures due to the movement of the pediatric patients. Whenever possible use techniques based on the lowest exposure times.

Shielding: We recommend you provide extra shielding of radiosensitive organs or tissues such as eyes, gonads and thyroid glands. Applying a correct collimation will help to protect the patient against excessive radiation as well. Please review the following scientific literature regarding pediatric radiosensitivity: GROSSMAN, Herman. "Radiation Protection in Diagnostic Radiography of Children". *Pediatric Radiology*, Vol. 51, (No. 1): 141–144, January, 1973:

<http://pediatrics.aappublications.org/cgi/reprint/51/1/141>.

Technique factors: You should take steps to reduce technique factors to the lowest possible levels consistent with good image acquisition and to limit the duration of fluoroscopy sequences and rapid sequences.

For example if your adult abdomen settings are: 70–85 kVp, 200–400 mA, 15–80 mAs, consider starting at 65–75 kVp, 100–160 mA, 2.5–10 mAs for a pediatric patient. Whenever possible use high kVp techniques and large SID (Source Image Distance).

Summary:

- Image only when there is a clear medical benefit.
- Image only the indicated area.
- Use the lowest amount of radiation for adequate imaging based on size of the child (reducing tube output – kVp and mAs, limiting the duration of dynamic imaging).
- Try to use always short exposure times, large SID values and immobilizing devices.
- Avoid multiple scans and use alternative diagnostic studies (such as ultrasound or MRI) when possible.

Stopping the DR detector

Depending on the configuration, the DR detector turns off automatically when the NX software is stopped.

To stop the DR detector manually:

1. If the DR detector is connected to the System Control Unit via the DR detector cable, turn off the System Control Unit using the power switch.
Depending on the configuration, the DR detector will be stopped automatically.

2. Turn off the detector.

Press and hold the power button for 3 seconds.

The power indicator light is off.

3. Put the detector in an empty slot of the DR detector charging stand to charge the battery.

Insert the DR detector with the tube side to the right.

The status indicator for the slot in which the detector is inserted, lights up yellow. The battery is charging.



Note When the power supply of the battery charger is switched off (e.g. when it's powered from a DR system that is shut down), the battery of the DR detector will slowly discharge. To prevent this, turn off the DR detector.



Note When the detector will not be used for some time, remove the battery. Otherwise, overdischarge may occur, leading to a shorter battery life.



Note When not in use, keep the detector, handle unit with grid in a designated location or in a location where they are safe and cannot fall down.

Related information

[Charging the DR detector in the DR detector charging stand](#) on page 92

Automatic exposure detection

Depending on the configuration, the DR detector detects X-ray exposure to automatically perform the image acquisition.

Before performing the exposure, the DR detector must be ready. Check the status of the DR detector in the DR Detector Switch.



Warning: The sensor for automatic exposure detection must be in the exposed area. Positioning the sensor for automatic exposure detection outside the exposed area can cause failure to trigger the image acquisition.



Warning: Very short exposure time can cause failure to trigger the image acquisition. Use an exposure time of at least 3 ms.



Warning: Specific exposure conditions (use of grid, thickness of the exposed object) can cause failure to trigger the image acquisition or horizontal artifacts in the acquired image.

Related information

[Positioning the XD 14, XD*14](#) on page 77

Attaching the handle unit with anti-scatter grid

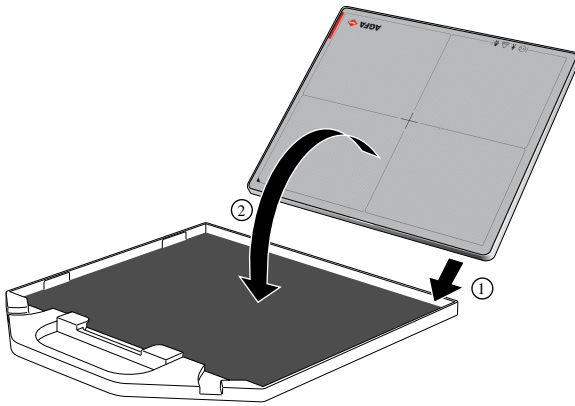

Caution: To safely attach the handle unit for making exposures using the grid, follow these instructions.

1. Lay down the grid on a flat surface.
2. Lay the DR detector in the grid, bottom edge first, with the tube side facing down (1).
3. Attach the grid to the DR detector (2).



Warning: Use only the grid that is supplied as option to the DR detector.

Attaching the handle unit without anti-scatter grid

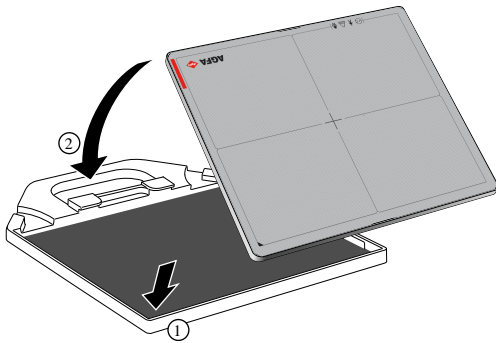

To attach the handle unit for making exposures without using the grid

1. Lay down the handle unit on a flat surface.
2. Lay the DR detector in the handle unit, bottom edge first, with the tube side facing up (1).
3. Attach the handle unit to the DR detector (2).

Advanced Operating

- [Viewing the detector status](#) on page 88
- [Charging a battery](#) on page 91
- [Replacing the battery](#) on page 96
- [Managing network connections in client mode configuration](#) on page 97
- [Managing network connections in access point mode configuration](#) on page 98

Viewing the detector status

The status display on the side of the DR detector is turned off by default.

The status display is controlled by pressing the power button (or the **AP mode** button).

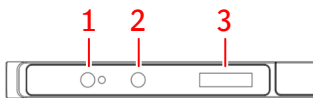

1. Power button with indicator light
2. **AP mode** button
3. Status display

Figure 20: DR detector status display

1. Press the power button for about 1 second.

The status display turns on and shows the status of the DR detector:

- Battery status.
- Connection status.

2. Press the power button again.

The status display shows the IP address of the DR detector.

3. Press the power button again.



The status display shows the SSID name used by the DR detector.

The status display is turned off automatically after 60 seconds.

- [Battery status](#) on page 89
- [Connection status](#) on page 90

Battery status

Table 5: Battery status

	No battery is present, or battery charge level is below the minimum. If two batteries are in the detector, the minimum charge level is 2%. If one battery is in the detector, the minimum charge level is 5%.
	The battery is being charged. The bar inside the battery icon represents the current charge level.
	The battery is in use. The bar inside the battery icon represents the current charge level.

Connection status

Table 6: Access point mode: the DR detector is acting as access point for wireless network

	The DR detector is acting as access point for wireless network
---	--

Table 7: Client mode: the DR detector is connected to a wireless network









Sy	Preset Identifier (Default "Sy" if not using Preset switching)
	Wifi connection status is very good
	Wifi connection status is good
	Wifi connection status is normal
	Wifi connection status is bad
	Wifi connection status is very bad
	DR detector is disconnected

Table 8: The DR detector is connected via the DR detector cable

	Wired DR detector (connection speed 1 Gbps)
	Wired DR detector (connection speed below 100 Mbps)

Charging a battery

There are 4 ways to charge a battery (depending on the available accessories):

- Put the detector in an empty slot of the DR detector charging stand.
- Connect the power adapter with the USB Type-C cable to the DR detector.
- Connect the DR detector cable to the DR detector and switch on the System Control Unit.
- Remove the battery from the DR detector and insert it in an empty slot of the DR detector dual battery charger.

The charge level of the battery is monitored and it is kept at maximum level until the battery is removed from the battery charger.

The DR detector can be configured to reduce the maximum charge level to 90%, in order to preserve battery life in installations where the detector is charging most of the time. This option is not available on all detector versions.

A battery level for recharging can be configured, meaning that when connecting the detector to a charger, it will not start charging the battery if the battery level is still higher than the configured level for recharging. This is indicated by the LED blinking eight times. On the DR detector charging stand a series of eight beeps will notify the user that the battery is not being charged.

- [Charging the DR detector in the DR detector charging stand](#) on page 92
- [Charging the DR detector using the power adapter](#) on page 93
- [Charging the battery using the DR detector cable](#) on page 94
- [Charging a battery in the dual battery charger](#) on page 95

Related information

[Safety directions for the DR detector battery](#) on page 67

[Safety directions for the power supply](#) on page 65

Charging the DR detector in the DR detector charging stand

A DR detector can be charged in either of both slots of the DR detector charging stand, or two detectors can be charged simultaneously.

1. Hold the DR detector with the tube side facing right.
2. Insert the DR detector in an empty slot of the DR detector charging stand.

Slide the detector in horizontally. Inserting it vertically may damage the contact pins.

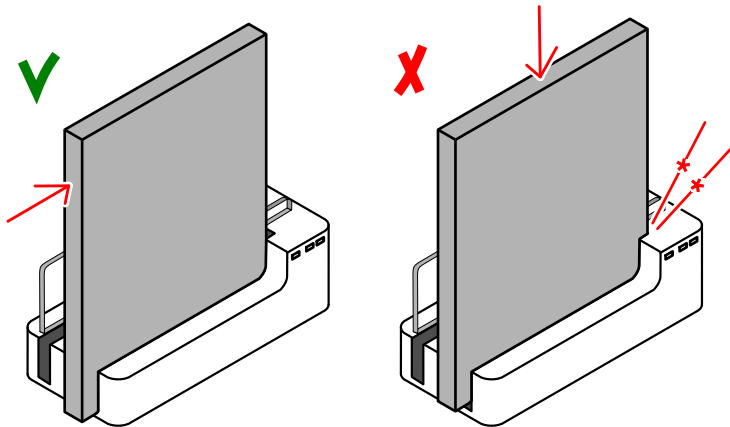

Figure 21: Inserting the DR detector in the DR detector charging stand

The corresponding status indicator lights up orange to indicate that the battery is charging.

When the battery is fully charged, the status indicator light turns green.

Related information

[DR detector charging stand](#) on page 17

Charging the DR detector using the power adapter



Caution: Charge the battery in an environment within a temperature range of 15 to 35 °C. Not doing so may result in battery leakage, overheating or damage. Not doing so may also lead to a decrease in the battery efficiency or capacity.

1. Plug the AC-DC power adapter into the wall socket.
2. Connect the USB Type-C cable to the connector on the DR detector.

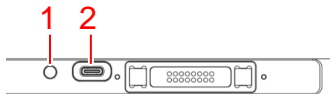

1. Battery status indicator
2. Connector for power adapter (USB Type-C)

Figure 22: Connector for power adapter (USB Type-C)

The battery status indicator lights up orange to indicate that the battery is charging.

3. When the DR detector is turned on, the battery status can be read from the status display.

When the battery is fully charged, the batterystatus indicator light turns green.

Charging the battery using the DR detector cable

Connect the DR detector cable to charge the battery that is attached to the DR detector. The battery status can be read from the **DR Detector Switch** on the MUSICA Acquisition Workstation.

While charging, the DR detector can still be used. The DR detector can also be used with the DR detector cable connected without a battery.

Related information

[DR detector cable](#) on page 21

Charging a battery in the dual battery charger

A battery can be charged in either of both slots of the battery charger, or two batteries can be charged simultaneously.

1. Insert a battery in an empty slot of the battery charger.

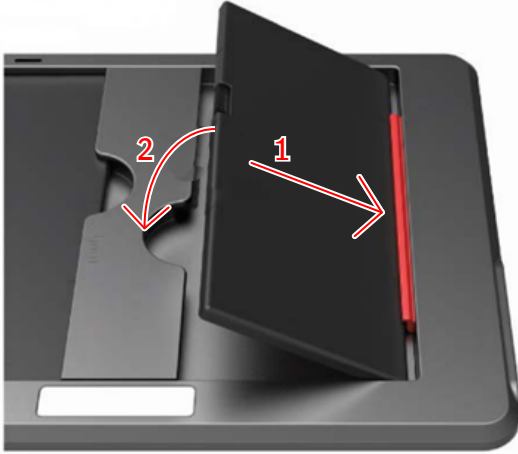

Figure 23: Inserting the battery in the battery charger

The corresponding status indicator lights up orange to indicate that the battery is charging.

2. Remove the battery when the status indicator for the slot turns green.

Replacing the battery

To replace the battery, a flat-head screwdriver is required.

For regular use, the other means for charging the DR detector are recommended. Battery replacement may be required if the battery is broken or if there is no time for regular charging and a back-up battery is available.

1. Turn off the DR detector.

Press and hold the power button (approx. 3 seconds).

2. Use the flat-head screwdriver to loosen the knobs that secure the battery cover plate.

Turn the knobs counterclockwise a quarter turn.

3. Take off the cover plate.

4. Remove the battery.

5. Insert the fresh battery.

Make sure that the orientation of the battery is correct, so that the electrical contacts of the battery connect to the electrical contacts of the DR detector.

6. Put the cover plate in place.

7. Use the flat-head screwdriver to secure the battery cover plate.

8. Turn the knobs clockwise a quarter turn.

9. Turn on the detector.

Press and hold the power button for 1 second.

Managing network connections in client mode configuration

The DR detector is configured for client mode.



Figure 24: Client mode

Each workstation has an access point or a System Control Unit.

Multiple DR detectors can be connected to a MUSICA Acquisition Workstation simultaneously.

The DR detector can be used for examinations on multiple MUSICA Acquisition Workstation.

- [Connecting to another MUSICA Acquisition Workstation \(client mode\)](#) on page 97

Connecting to another MUSICA Acquisition Workstation (client mode)

The DR detector is configured in client mode.

To connect the DR detector to another MUSICA Acquisition Workstation:

1. Take the DR detector near the MUSICA Acquisition Workstation.
2. Press and hold the **AP mode** button for 3 seconds.



Figure 25: AP mode button

The detector status display shows "**AP scan**", indicating that the wireless network is being scanned. From a list of access points that is configured upon installation, the one with the highest signal strength is automatically selected. After a while the detector display shows "**Change AP**".

Note that if the DR detector was already connected, that access point will be ignored, even if it has the highest signal strength. To avoid confusion, always check the SSID name of the access point to which the DR detector is connected.

3. Wait until the connection to the MUSICA Acquisition Workstation is established. The detector status display shows the signal strength.



4. Press the **AP mode** button for 1 second to display the SSID name of the access point to which the DR detector is connected.

Related information

[Configuration](#) on page 11

Managing network connections in access point mode configuration

The DR detector is configured for access point mode.



Figure 26: Access point mode

Multiple DR detectors can be used on the same MUSICA Acquisition Workstation, but they cannot be connected simultaneously.

The DR detector can be used for examinations on a single MUSICA Acquisition Workstation. The MUSICA Acquisition Workstation connects to the detector, which is acting as an access point. The user must manually switch the wireless connection between the hospital network and the DR detector.

Additionally, the DR detector can be switched to client mode. The detector can be configured up-on installation with another MUSICA Acquisition Workstation (with access point or System Control Unit) to which it will connect in this status.

- [Switching between the wireless DR detector and the wireless hospital network](#) on page 99
- [Switching temporarily to client mode](#) on page 101
- [Connecting the MUSICA Acquisition Workstation to another DR detector \(access point mode\)](#) on page 102

Switching between the wireless DR detector and the wireless hospital network

The MUSICA Acquisition Workstation can be configured to connect to a wireless DR detector as well as to a wireless hospital network.

In a configuration without System Control Unit or without a wireless access point that is connected to the workstation, the DR detector communicates via the internal wireless adapter of the MUSICA Acquisition Workstation. Only one connection can be active at a time. The user must manually switch between the wireless connection to the hospital network and the wireless connection to the DR detector.



Warning: If the network connection is interrupted, the MUSICA Acquisition Workstation may reconnect to different access point if the option **Connect automatically** in the Windows wifi settings is enabled. Do not enable the option **Connect automatically** when connecting to the hospital network or to a DR detector.

To switch between wireless networks:

1. Swipe in from the right side of the screen.

The Windows **action center** is displayed.

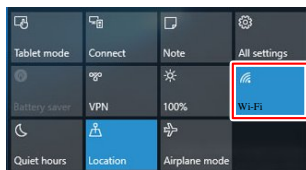

Figure 27: Windows action center with Wifi button highlighted

2. Touch the **Wifi** button
The available wireless networks are displayed.
3. Select the wireless network.

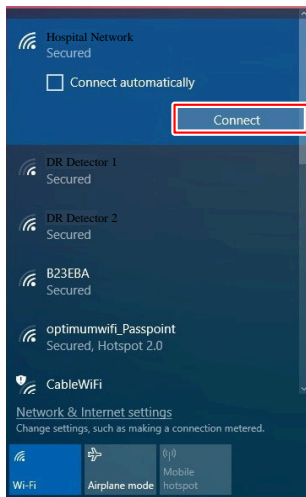

Figure 28: Available wireless networks

- To connect to the hospital network, select name of the hospital network.

The MUSICA Acquisition Workstation is connected to the hospital network to retrieve data from the RIS or to print or archive images.

No communication to the DR Detector is possible, no exposures can be performed.

- To connect to the wireless DR Detector, select the name of the detector.

The MUSICA Acquisition Workstation is connected to the DR Detector to make exposures.

No communication to the hospital network is possible, e.g. to RIS or PACS.

4. Touch the **Connect** button.

The network connection is switched to the selected wireless network.

Related information

[Configuration](#) on page 11

Switching temporarily to client mode

The DR detector is configured in access point mode.

The DR detector can be temporarily switched to client mode, to connect to another MUSICA Acquisition Workstation. The detector can be configured upon installation with a single MUSICA Acquisition Workstation (with access point or System Control Unit) to which it will connect in this status.

To switch the DR detector to client mode:

1. Take the DR detector near the MUSICA Acquisition Workstation with the access point.
2. Press and hold the **AP mode** button for 3 seconds.



Figure 29: AP mode button

The detector status display shows "**STA Mode Start**", indicating that the client mode is being activated.

3. Wait until the connection to the MUSICA Acquisition Workstation is established. The detector status display shows the signal strength.



4. Perform the examinations.
5. To return the DR detector to access point mode, press and hold the **AP mode** button for 3 seconds.

The detector status display shows "**AP Mode Start**", indicating that the access point mode is being activated.

After a while, the detector status display shows the access point icon.



Related information

[Configuration](#) on page 11

Connecting the MUSICA Acquisition Workstation to another DR detector (access point mode)

The DR detector is configured in access point mode.



Warning: If the network connection is interrupted, the MUSICA Acquisition Workstation may reconnect to different access point if the option **Connect automatically** in the Windows wifi settings is enabled. Do not enable the option **Connect automatically** when connecting to the hospital network or to a DR detector.

To connect the MUSICA Acquisition Workstation to another DR detector:

1. On the MUSICA Acquisition Workstation, swipe in from the right side of the screen.

The Windows **action center** is displayed.

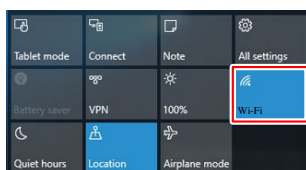

Figure 30: Windows action center with Wifi button highlighted

2. Touch the **Wifi** button
The available wireless networks are displayed.
3. Select the name of the DR detector.
4. Touch the **Connect** button.

The MUSICA Acquisition Workstation is connected to the DR detector.

Related information

[Configuration](#) on page 11



Problem solving

- [Artifact in DR Detector images](#) on page 103
- [DR detector not ready for exposure](#) on page 104
- [The MUSICA Acquisition Workstation is connected to the DR detector, but the DR detector is not active \(access point mode\)](#) on page 105
- [Images are not sent to the printer or to the PACS archive](#) on page 106
- [Identifying problems](#) on page 107

Artifact in DR Detector images

Details	An artifact is visible in the images produced by a DR Detector.
Cause	Exposure conditions have changed significantly since latest calibration.
Brief Solution	Perform calibration of the DR Detector. For details, refer to the DR Detector Calibration Key User Manual (document 0134).

DR detector not ready for exposure

Details	The DR detector is turned on. The DR detector status icon on the DR Detector Switch is not green.
Cause (only if the DR detector is configured in client mode and used on more than one MUSICA Acquisition Workstation)	The DR detector is not connected to the MUSICA Acquisition Workstation.
Brief Solution	Connect the DR detector to the MUSICA Acquisition Workstation.
Cause (only if the DR detector is configured in access point mode)	The AP mode button has been pushed accidentally.
Brief Solution	<p>Check the detector status display.</p> <ul style="list-style-type: none"> If the DR detector is in client mode, the connection status is displayed.  <ul style="list-style-type: none"> If the DR detector is in access point mode, the access point icon is displayed.  <p>If the status does not match the way it should communicate to the workstation, press and hold the AP mode button for 3 seconds.</p> <p>The DR detector switches to the other communication mode.</p>
Cause (only if the DR detector is configured in access point mode)	The MUSICA Acquisition Workstation is not connected to the DR detector via the wireless network.
Brief Solution	Use the Windows wifi setting to connect the MUSICA Acquisition Workstation to the wireless network of the DR detector.

Related information

[Viewing the detector status](#) on page 88

[Connecting to another MUSICA Acquisition Workstation \(client mode\)](#) on page 97

[Switching between the wireless DR detector and the wireless hospital network](#) on page 99

[Switching temporarily to client mode](#) on page 101

[Connecting the MUSICA Acquisition Workstation to another DR detector \(access point mode\)](#) on page 102

The MUSICA Acquisition Workstation is connected to the DR detector, but the DR detector is not active (access point mode)

Details	The DR detector is configured for access point mode. The Wifi settings in Windows show that the MUSICA Acquisition Workstation is connected to the DR detector, but the DR Detector Switch shows an error status for the DR detector.
Cause	Another MUSICA Acquisition Workstation is still connected to the DR detector.
Brief Solution	On the other MUSICA Acquisition Workstation, switch to the wireless hospital network to disconnect from the DR detector.

Images are not sent to the printer or to the PACS archive

Details	The exam is closed, but the images are not sent to the printer or to the PACS archive.
Cause (only if the DR detector communicates via the internal wireless adapter of the workstation)	The MUSICA Acquisition Workstation has not been connected to the hospital network.
Brief solution	Use the Windows wifi setting to connect the MUSICA Acquisition Workstation to the hospital network. The images will be sent automatically as soon as a connection to the hospital network is active.

Related information

[Switching between the wireless DR detector and the wireless hospital network](#) on page 99

Identifying problems

Please refer to the details of following symptoms or error messages. If the problem persists, turn off the detector and consult your sales representative or local dealer.



Warning: Improper changes, additions, maintenance or repair of the system can lead to personal injury, electrical shock and damage to the equipment. Safety is only guaranteed when changes, additions, maintenance or repairs are carried out by an Agfa certified field service engineer. A non certified engineer performing a modification or service intervention on a medical device, acts on his own responsibility and makes the warranty void.

Symptom	Cause	Remedy
The detector will not turn on.	The battery is not attached.	Attach the battery.
	The battery pack is not charged.	Fully charge the battery pack.
	The battery pack is broken.	Replace the battery pack.
The status indicator of the System Control Unit does not light up.	The power cord is unplugged from the AC outlet.	Connect the plug to the AC outlet firmly. If it still does not work, replace the System Control Unit.
The status indicator of the System Control Unit does not light up in green.	A hardware error has occurred.	Turn off the System Control Unit and turn it on again. If it still does not work, replace the System Control Unit.
The detector status display shows an error number (e.g. "ERR_01").	An error has occurred.	Turn off the DR Detector and turn it on again. Follow the instructions for starting up the DR detector. If the error persists call Service.
A fully charged battery is consumed quickly.	The battery capacity decreases.	The DR Detector battery can deteriorate because of its characteristics and structure. For purchase of consumables, contact your sales representative or local dealer.
	The battery was charged or used in low temperatures.	In low temperatures the battery capacity decreases. Use a battery charged in normal temperatures.
The battery bay is unusually hot.	The battery is malfunctioning.	Stop using the battery and consult your sales representative or local dealer.

Technical Data

- [XD 14, XD*14 technical data](#) on page 109

- [DR detector battery technical data](#) on page 111
- [DR detector charging stand technical data](#) on page 112
- [DR detector dual battery charger technical data](#) on page 113
- [System Control Unit](#) on page 114
- [Mini System Control Unit](#) on page 115
- [System Control Unit Lite](#) on page 116

XD 14, XD*14 technical data

Commercial name	XD 14, XD*14
Manufacturer	
Manufacturer DR Detector	Vieworks Co., Ltd. 41-3, Burim-ro 170beon-gil, Dongan-gu, Anyang-si, Gyeonggi-do, 14055 Republic of Korea
Distributor DR Detector	Agfa NV Septestraat 27, B-2640 Mortsels - Belgium
Original manufacturer model name	
XD 14	FXRD-3643VAW
XD*14	FXRD-3643VAW PLUS
Electrical connection	
System Control Unit with DR detector cable	DC 24 V, max. 0.625 A
Power adapter with USB Type-C cable	DC 18 V, max. 2.78 A
Power consumption	max. 24 W max. 80 W (while battery is charging)
Operating time using one battery (early in the battery life)	7 hours (image acquisition each 100 seconds) 8 hours (standby)
Operating time using two batteries (early in the battery life)	15 hours (image acquisition each 100 seconds) 16 hours (standby)
Network connection	
Wireless connection	IEEE 802.11n/ac (2.4 GHz/5 GHz)
Environmental conditions (during normal operation)	
Room temperature	between 0 °C and +40 °C
Humidity (non condensing)	between 5% and 90% RH (non-condensing)
Atmospheric pressure	between 700 hPa and 1060 hPa
Environmental conditions (during storage and transport)	
Temperature (ambient)	between -15 °C and +55 °C
Humidity (non condensing)	between 5% and 90% (non-condensing)
Atmospheric pressure	between 500 and 1060 hPa
Dimensions	

Dimensions width x length x height	approx. 384.0 x 460.0 x 15.0 mm
Weight XD 14	2.95 kg (incl. one battery) 3.15 kg (incl. two batteries)
Weight XD*14	3.10 kg (incl. one battery), 3.30 kg (incl. two batteries)
Load	
Maximum load	200 kg on an area of 40 mm in diameter
Maximum total load	400 kg over the whole detector surface
Vibration tolerance	2 G during normal operation 5G during storage and transport
Shock tolerance	20 G during normal operation 30 G during storage and transport
Drop limit	1000 mm (once)
Image acquisition	
Image acquisition time (minimum cycle time)	4 s
Conversion screen	CsI
Pixel size	140 μm
Active pixel matrix	2560 x 3072
Effective pixel matrix	2536 x 3048
Detector type	amorphous silicium
Active area size	358 mm x 430 mm
Effective area size	355.0 mm x 426.7 mm

DR detector battery technical data

Type of product	Rechargeable lithium ion polymer battery pack
Part number	FXRB-04A
Dimensions	
Dimensions (length x width x height)	189.0 mm x 89.0 mm x 6.65 mm
Weight	185 g
Battery output	
Output voltage	DC +11.55 V
Capacity	3400 mAh
Charging time	
Using the DR detector cable	Max. 7 hours
Using the battery charger Using the DR detector cradle Using the Power adapter	Max. 2 hours (approx. 70% of charge within 1 hour)
Lifecycle	
Preventive maintenance frequency.	No preventive maintenance required.
Estimated product life	Estimated product life: 800 charge cycles

DR detector charging stand technical data

Type of product	Lithium ion battery pack charger
Part number	FXRR-01A
Simultaneous charging	2 detectors
Dimensions	
Dimensions (width x height x depth)	410.0 mm x 159.0 mm x 168.0 mm
Weight	4040 g
Electrical connection	
Rated Power Supply	DC +24V, 2 A max.
Lifecycle	
Preventive maintenance frequency.	No preventive maintenance required.

DR detector dual battery charger technical data

Type of product	Lithium ion battery pack charger
Part number	FXRC-04A
Simultaneous charging	2 batteries
Dimensions	
Dimensions (length × width × height)	304.0 mm × 230.0 mm × 15.0 mm
Electrical connection	
Rated power supply	DC +24 V, 3.33 A max.
Lifecycle	
Preventive maintenance frequency.	No preventive maintenance required.

System Control Unit

Part number	FXRS-03A
Rated power supply (input)	AC100 to 240V, 50/60Hz, Max. 2.0-0.8A
Rated power supply (output)	DC +24V 3.25A, 78W
Wireless connection	IEEE 802.11n (2.4 GHz/5 GHz)
Dimensions (width x height x depth)	300 mm x 236 mm x 58 mm (140 mm antenna height)
Weight	2.8 kg

Mini System Control Unit

Part number	FXRS-04A
Rated power supply (input)	DC +24V 2A max
Wireless connection	IEEE 802.11n (2.4 GHz/5 GHz)
Antenna	137mm (2EA, dual band)
Cable connection port	Gigabit Ethernet port (3EA) PoE (Power over Ethernet) Port (1EA)
Dimensions (width x height x depth)	210 mm x 170 mm x 45 mm (140 mm antenna height)
Weight	1.2 kg

System Control Unit Lite

Part number	FXRP-02A
Rated power supply (input)	DC +24V 1A max
Cable connection port	Gigabit Ethernet port (1EA) PoE (Power over Ethernet) Port (1EA)
Dimensions (width x height x depth)	109 mm x 108 mm x 29.5 mm
Weight	0.33 kg

Remarks for HF-emission and immunity

- [EMC \(Electromagnetic Compatibility\) Statements](#) on page 117
- [Electromagnetic emissions](#) on page 118
- [Electromagnetic immunity](#) on page 119
- [For U.S.A.](#) on page 121

EMC (Electromagnetic Compatibility) Statements



Warning: This device has been tested for EMI/EMC compliance, but interference can still occur in an electromagnetically noisy location. Attempt to maintain a suitable distance between electrical devices to prevent malfunction.



Warning: Obtaining diagnostic images and transferring them to a PC (workstation) are the essential performance of the DR detector. If the required performance is degraded or lost due to electromagnetic interference, images that are not suitable for diagnosis may be obtained or the image may be lost.

Electromagnetic emissions

This device has been tested for a normal hospital environment as described below.

The user of the device should ensure that it is used in such an environment.

Nevertheless the HF-emission and immunity can be influenced by connected data cables depending on length and the manner of installation.

Emissions test	Compliance	Electromagnetic Environment Guidelines
RF emissions in accordance with CISPR 11	Group 1	This device uses RF energy only for its internal function. Therefore, its RF emissions are very low and are not likely to cause any interference in nearby electronic equipment.
RF emissions in accordance with CISPR 11	Class A	The device is directly connected to a low voltage power supply network, and can be used in all facilities except the ones that supply voltage to home facilities or buildings. The emissions characteristics of this equipment make it suitable for use in industrial areas and hospitals (CISPR 11 class A). If it is used in a residential environment (for which CISPR 11 class B is normally required) this equipment might not offer adequate protection to radio-frequency communication services. The user might need to take mitigation measures, such as relocating or re-orienting the equipment.
Harmonic emissions in accordance with IEC 61000-3-2	Class A	
Voltage fluctuations / flicker emissions in accordance with IEC 61000-3-3	Complies (*)	

(*) Applies to regions where the rated voltage is 220 V or higher. Not applicable to regions where the rated voltage is less than 220 V.

Electromagnetic immunity

This DR Detector is intended for operation in the electromagnetic environment given below. The user of the DR Detector should ensure that it is used in such an environment.

Resistance to Jamming Test	IEC 60601 Test Level	Level of Agreement	Electromagnetic Environment Guidelines
Discharge of static electricity in accordance with IEC 61000-4-2	± 8 kV contact discharge ± 15 kV air discharge	± 8 contact discharge ± 15 kV air discharge	Floors should consist of wood, concrete or ceramic tiles. The relative humidity must be at least 30%, if the floor is made of synthetic material.
Fast transient electrical disturbance variables / bursts in accordance with IEC 61000-4-4	± 2 kV for network leads ± 1 kV for entry and outlet leads	± 2 kV for network leads ± 1 kV for entry and outlet leads	The quality of the voltage supplied should correspond to a typical commercial or clinical environment.
Impulse voltages (surges) in accordance with IEC 61000-4-5	± 1 kV push-pull voltage ± 2 kV common mode voltage	± 1 kV push-pull voltage ± 2 kV common mode voltage	The quality of the voltage supplied should correspond to that of a typical commercial or clinical environment.
Voltage breakthroughs, short term interruptions and variations in the voltage supplied in accordance with IEC 61000-4-11	100% reduction for 0.5 cycle at 0, 45, 90, 135, 180, 225, 270 and 315 degrees 100% reduction for 1 cycle 30% reduction for 25/30 cycles at 0 degree 100% reduction for 250/300 cycles (5 sec.)	100% reduction for 0.5 cycle at 0, 45, 90, 135, 180, 225, 270 and 315 degrees 100% reduction for 1 cycle 30% reduction for 25/30 cycles at 0 degree 100% reduction for 250/300 cycles (5 sec.)	The quality of the voltage supply should correspond to that of a typical commercial or clinical environment. If the user wants the DR Detector to work continuously, even when the energy supply is interrupted, it is recommended to use an energy supply free of interruptions or a battery.
Magnetic field at the supply frequency (50/60 Hz) in accordance with IEC 61000-4-8	30 A/m	30 A/m	Magnetic field at the network frequency should correspond to the typical values as they are in a commercial and clinical environment.

Tests of Resistance to Disruption	IEC 60601 Test Level	Level of Agreement	Electromagnetic Environment
-----------------------------------	----------------------	--------------------	-----------------------------

Conducted high frequency disturbance variables in accordance with IEC 61000-4-6	3 V _{eff} 150 kHz to 80 MHz 6 V _{eff} in the ISM bands 150 KHz to 80 MHz	3 V _{eff} 150 kHz to 80 MHz 6 V _{eff} in the ISM bands 150 KHz to 80 MHz	The electromagnetic field strength of a stationary RF transmitter determined by an electromagnetic test survey must be less than the compliance level of each frequency range.
Radiated high frequency disturbance variables in accordance with IEC 61000-4-3	3 V/m 80 MHz to 2.7 GHz	3 V/m 80 MHz to 2.7 GHz	
			Interference may occur in the vicinity of equipment marked with the symbol: 



Note The higher value will apply at 80 MHz and 800 MHz.



Note These Guidelines may not apply to all situations. The dispersion of electromagnetic waves is influenced by absorption and reflections from buildings, objects and people.



Warning: Field strengths from fixed transmitters, such as base stations for radio (cellular/cordless) telephones and land mobile radios, amateur radio, AM and FM radio broadcast and TV broadcast cannot be predicted theoretically with accuracy. To assess the electromagnetic environment due to fixed RF transmitters, an electromagnetic site survey should be considered. If the measured field strength in the location in which this device is used exceeds the applicable RF compliance level above, this device should be observed to verify normal operation. If abnormal performance is observed, additional measures may be necessary, such as re-orienting or relocating this device.



Warning: The field strength will be lower than 3 V/m above the frequency range from 150 kHz to 80 MHz.



Warning: Portable RF communications equipment (including peripherals such as antenna cables and external antennas) should be used no closer than 30cm (12 inches) to any part of the DR detector, including cables specified for use with the equipment. Otherwise, degradation of the performance of this equipment could result.

For U.S.A.

This device complies with Part 15 of the FCC Rules.

Operation is subject to the following two conditions:

- This device may not cause harmful interference.
- This device must accept any interference received, including interference that may cause undesired operation.

This equipment has been tested and found to comply with the limits for a Class A digital device, pursuant to part 15 of the FCC Rules. These limits are designed to provide reasonable protection against harmful interference when the equipment is operated in a residential environment.

This equipment generates, uses, and can radiate radio frequency energy and, if not installed and used in accordance with the instruction manual, may cause harmful interference to radio communications.

However, there is no guarantee that interference will not occur in a particular installation. If this equipment does cause harmful interference to radio or television reception, which can be determined by turning the equipment off and on, the user is encouraged to try to correct the interference by one or more of the following measure.

- Reorient or relocate the receiving antenna.
- Increase the separation between the equipment and receiver.
- Connect the equipment into an outlet on a circuit different from where the receiver is connected.
- Consult the distributor or an experienced radio/TV technician for help.

FCC WARNING:

Changes or modifications not expressly approved by the party responsible for compliance could void the user's authority to operate the equipment.