

# Valory (system with floor mounted column)

5540/100

---

## User Manual

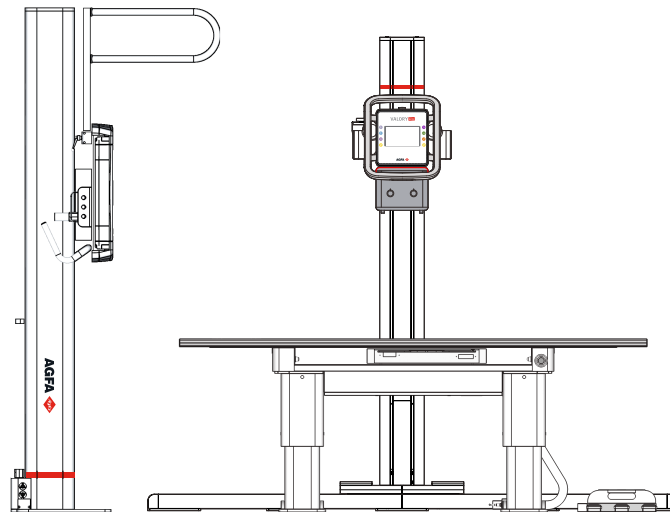

# Contents

<b>Legal Notice.....</b>	<b>6</b>
<b>Introduction to this Manual.....</b>	<b>6</b>
Scope of this Manual.....	7
About the safety notices in this document.....	8
Disclaimer.....	9
<b>Introduction.....</b>	<b>9</b>
Intended Use.....	10
Intended User.....	11
System overview.....	12
Options and Accessories.....	14
Operation Controls.....	15
Radiographic table.....	16
Radiographic wall stand.....	17
X-ray tube head unit.....	18
MUSICA Acquisition Workstation (NX).....	20
Software Console.....	21
DR Detector Switch.....	22
X-ray generator mini console (Spellman).....	23
Manual collimator.....	25
Portable DR detector.....	26
Emergency stop button.....	27
Emergency shutdown power switch.....	28
Power off behaviour.....	29
Installation.....	30
HF-emission and immunity.....	30
Radiation Protection.....	31
Monitoring of Personnel.....	32
Protected area and significant zones of occupancy.....	33
Guidelines for Pediatric Applications.....	38
Effect of SID on patient dose.....	39
Labels.....	40
Warning labels on the radiographic table.....	42
Warning labels on the radiographic wall stand.....	43
Warning labels on the floor mounted column and tube head unit.....	44
Type label.....	45
Additional labeling of the radiographic table.....	46
Additional labeling of the radiographic wall stand.....	47
Additional labeling of the floor mounted column and tube head unit.....	48
Additional labeling of the main control box.....	49
Labeling of the X-ray generator mini console.....	50
Type labels of accessories.....	51
DR Detector identification label.....	53
About the software.....	54
Cleaning and disinfecting.....	55
Maintenance.....	58

Maintenance actions.....	59
Checklist before and after operation.....	61
Checklist for the floor mounted column and tube head unit.....	63
Checklist for the radiographic table.....	64
Checklist for the radiographic wall stand.....	65
<b>Safety Directions.....</b>	<b>65</b>
General Safety Directions.....	66
Safety Directions for the X-Ray System.....	68
Safety Directions for the radiographic table.....	69
Safety directions for the floor mounted column.....	70
<b>Basic Workflow.....</b>	<b>70</b>
Starting the System.....	71
Automated workflow for warming-up of X-ray tube.....	71
Performing an exposure using the DR Detector.....	73
Step 1: retrieve the patient info.....	74
Step 2: select the exposure.....	75
Step 3: Prepare the exposure.....	76
Step 4: Check the exposure settings.....	77
Step 5: execute the exposure.....	78
Step 6: perform a quality control.....	78
Performing an exposure using a CR cassette.....	79
Step 1: retrieve the patient info.....	80
Step 2: select the exposure.....	81
Step 3: prepare the exposure.....	82
Step 4: check the exposure settings.....	82
Step 5: execute the exposure.....	83
Step 6: repeat steps 2 to 5 for the next subexposures.....	83
Step 7: digitize the image.....	83
Step 8: perform a quality control.....	83
Stopping the System.....	84
<b>Software Console.....</b>	<b>84</b>
X-ray modality status frame.....	85
Ready for exposure status.....	86
Modality Position.....	87
DR Detector Switch.....	88
Filter Status.....	89
Anti-scatter grid status.....	90
Radiation status.....	91
Unknown status.....	92
Generator controls.....	93
One point, two point and three point working modes.....	94
Radiographic Parameters.....	95
Focal Spot Indicator.....	96
Automatic Exposure Control (AEC).....	97
X-ray tube load.....	100
DAP Value.....	101
Heat Units.....	102
X-ray modality controls.....	103
System messages screen.....	104

<b>Tube head display.....</b>	<b>105</b>
Status information on the tube head display.....	106
<b>Positioning the X-Ray Tube.....</b>	<b>108</b>
Stop positions.....	110
Centering the tube head on the table.....	111
Centering the tube head on the wall stand.....	113
<b>Positioning the Radiographic Table.....</b>	<b>114</b>
Positioning the floating tabletop.....	115
Adjusting height.....	116
Positioning the bucky.....	117
<b>Radiographic Table Accessories.....</b>	<b>117</b>
Mounting the patient hand grips.....	118
Lateral cassette holder.....	119
Lateral Exposures.....	119
Mounting the compression belt.....	120
Mattress.....	121
<b>Positioning the Radiographic Wall Stand.....</b>	<b>121</b>
<b>Radiographic Wall Stand Accessories.....</b>	<b>121</b>
Patient hand grips.....	122
Mounting the lateral arm rest.....	123
<b>Bucky.....</b>	<b>123</b>
Loading of the bucky in the table.....	125
Loading of the bucky in the wall stand.....	126
Unloading of the bucky in the table.....	127
Unloading of the bucky in the wall stand.....	128
Anti-scatter grids.....	129
Anti-scatter grids.....	130
Anti-scatter grid focal distance color indication.....	131
Storage box for DR detector and anti-scatter grids.....	132
Automatic Exposure Control (AEC).....	133
<b>X-Ray Generator Mini Console.....</b>	<b>133</b>
Starting and stopping the generator.....	134
X-ray tube start-up modes.....	135
X-ray generator messages and warning signals (Spellman).....	136
<b>Problem solving.....</b>	<b>136</b>
Restoring connection between generator and NX after generator failure.....	137
DR Detector is Exceeding the Maximum Working Temperature.....	138

DR detector must be recalibrated.....	139
Radiographic Parameter Limits.....	140
Warning messages.....	141

## **Product Information..... 141**

Compatibility.....	142
Connectivity.....	143
Compliance.....	144
General.....	145
Safety.....	145
Electromagnetic Compatibility.....	146
X-Ray Safety.....	146
X-Ray Accuracy.....	146
Environmental Compliance.....	146
Biocompatibility.....	146
Usability.....	146
Equipment Classification.....	147
Foot pedals.....	148
Applied Parts.....	149
Patient data security.....	150
Requirements on the operating environment.....	150
Product Complaints.....	151
Environmental protection.....	152
System Documentation.....	153
Training.....	154
Technical Data.....	155
Valory technical data.....	156
Generator Technical Data.....	157
Radiographic Table Technical Data.....	159
Wall stand technical data.....	160
Floor mounted column technical data.....	161
X-Ray Tube Technical Data.....	162
Bucky technical data.....	165
Automatic Exposure Control (AEC) Technical Data.....	166
Manual Collimator Technical Data.....	167
Dose Area Product Meter (IBA DAP) Technical Data.....	168
Portable DR detector technical data.....	169
Portable DR detector technical data (mounted fixed in the bucky).....	170
NX workstation technical data.....	171
Remarks for HF-emission and immunity.....	172
Immunity to RF wireless communication equipment.....	176
Precautions on EMC.....	177
Cables, transducers and accessories.....	178
Maintenance on EMC relevant parts.....	179

## Legal Notice

---

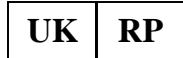

Agfa HealthCare UK Limited, 6-9 The Square, Stockley Park, Uxbridge, Middlesex UB11 1FW, UK

 Agfa NV, Septestraat 27, 2640 Mortsel - Belgium

For more information on Agfa products, please visit [medimg.agfa.com](https://medimg.agfa.com).

Agfa and the Agfa rhombus are trademarks of Agfa-Gevaert N.V., Belgium or its affiliates. Valory is a trademark of Agfa NV, Belgium or one of its affiliates. All other trademarks are held by their respective owners and are used in an editorial fashion with no intention of infringement.

Agfa NV makes no warranties or representation, expressed or implied, with respect to the accuracy, completeness or usefulness of the information contained in this document and specifically disclaims warranties of suitability for any particular purpose. Products and services may not be available for your local area. Please contact your local sales representative for availability information. Agfa NV diligently strives to provide as accurate information as possible, but shall not be responsible for any typographical error. Agfa NV shall under no circumstances be liable for any damage arising from the use or inability to use any information, apparatus, method or process disclosed in this document. Agfa NV reserves the right to make changes to this document without prior notice. The original version of this document is in English.

Copyright 2024 Agfa NV

All rights reserved.

Published by Agfa NV

2640 Mortsel - Belgium.

No part of this document may be reproduced, copied, adapted or transmitted in any form or by any means without the written permission of Agfa NV

## Introduction to this Manual

---

- [Scope of this Manual](#) on page 7
- [About the safety notices in this document](#) on page 8
- [Disclaimer](#) on page 9

## **Scope of this Manual**

---

This User Manual describes the features of the Valory system, an integrated X-Ray imaging system. It explains how the different components of the Valory system work together.

## About the safety notices in this document

---

The following samples show how warnings, cautions, instructions and notes appear in this document. The text explains their intended use.



**DANGER:** A danger safety notice indicates a hazardous situation of direct, immediate danger for a potential serious injury to a user, service engineer, patient or any other person.



**Warning:** A warning safety notice indicates a hazardous situation which can lead to a potential serious injury to a user, service engineer, patient or any other person.



**Caution:** A caution safety notice indicates a hazardous situation which can lead to a potential minor injury to a user, service engineer, patient or any other person.



An instruction is a direction which, if it is not followed, can cause damage to the equipment described in this manual or any other equipment or goods and can cause environmental pollution.



A prohibition is a direction which, if it is not followed, can cause damage to the equipment described in this manual or any other equipment or goods and can cause environmental pollution.



**Note** Notes provide advice and highlight unusual points. A note is not intended as an instruction.

## Disclaimer

---

Agfa assumes no liability for use of this document if any unauthorized changes to the content or format have been made.

Every care has been taken to ensure the accuracy of the information in this document. However, Agfa assumes no responsibility or liability for errors, inaccuracies or omissions that may appear in this document. To improve reliability, function or design Agfa reserves the right to change the product without further notice. This manual is provided without warranty of any kind, implied or expressed, including, but not limited to, the implied warranties of merchantability and fitness for a particular purpose.



**Note** In the United States, Federal law restricts this device on order of a physician for prescription use only.

## Introduction

---

- [Intended Use](#) on page 10
- [Intended User](#) on page 11
- [System overview](#) on page 12
- [Options and Accessories](#) on page 14
- [Operation Controls](#) on page 15
- [Installation](#) on page 30
- [Radiation Protection](#) on page 31
- [Labels](#) on page 40
- [Cleaning and disinfecting](#) on page 55
- [Maintenance](#) on page 58

## Intended Use

---

### Indications for Use

The Valory system is a General Radiography X-ray imaging system used in hospitals, clinics and medical practices by radiographers, radiologists and physicists to make, process and view static X-ray radiographic images of the skeleton (including skull, spinal column and extremities), chest, abdomen and other body parts on adults and pediatric patients.

Applications can be performed with the patient in sitting, standing or lying position.

The system is not intended for use in Mammography applications

## Intended User

---

This manual has been written for trained users of Agfa products and trained diagnostic X-Ray clinical personnel who have received proper training.

Users are those persons who actually handle the equipment and those who have authority over the equipment.

Before attempting to work with this equipment, the user must read, understand, note and strictly observe all warnings, cautions and safety markings on the equipment.

## System overview

---

Valory is a digital radiography X-ray system.

Valory is a modular system. This manual describes the system with the X-ray tube head on a **floor mounted column**.

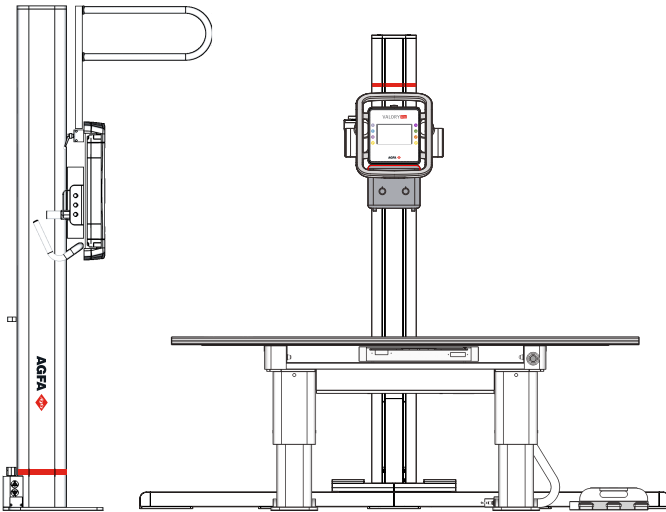

**Figure 1: Valory (system with floor mounted column)**

The complete system consists of the following components:

- Floor mounted column with X-ray tube and tube head display
- Manual collimator
- Radiographic table with motorized movement and a bucky to insert a DR Detector
- Radiographic wall stand with manual movement and a bucky to insert a DR Detector
- X-ray generator
- MUSICA Acquisition workstation (NX workstation)
- Automatic Exposure Control (AEC)
- Dose Area Product Meter (DAP, optional)

This configuration supports following functionality:

- automatic centering of the radiographic table
- bucky of the radiographic table tracks the longitudinal displacement of the X-ray tube

The use of the DR detector bucky is restricted to detectors with a size equivalent to 14x17 inch (35x43 cm) or to 17x17 inch (43x43 cm).

Alternative components:

- Radiographic table with fixed height
- Radiographic wall stand with fixed DR detector

Limited configurations:

- configuration without radiographic wall stand
- configuration without radiographic table
- configuration with only a floor mounted column with X-ray tube head

X-ray parameters are controlled using the software console on the MUSICA Acquisition workstation. The software console is available on the MUSICA Acquisition workstation, to synchronize the X-ray exposure parameters with the generator.

Valory can be used in combination with a CR digitizer and CR cassettes. The use of the bucky is restricted to CR cassettes with a size of 14x17 inch (35x43 cm) or 17x17 inch (43x43 cm). After each exposure, remove the CR cassette from the bucky and insert it in the digitizer. The system does not prevent double exposure of a CR cassette in the bucky.

Valory can be used in combination with a CR digitizer and a CR full body cassette holder to perform full leg full spine examinations. Refer to the CR Full Leg Full Spine User Manual (document 4408, part of the MUSICA Acquisition workstation User Documentation).

## Options and Accessories

---

The system is delivered with a set of labels. When using multiple DR Detectors, on the labels a nickname is written to identify the DR Detector. An identical label is attached to the bucky of the X-ray system to identify the dedicated workspace of each DR Detector.

For information on options and accessories, refer to these manuals:

- User manuals for the supported DR Detectors.

### **Related information**

[Radiographic Table Accessories](#) on page 117

[Radiographic Wall Stand Accessories](#) on page 121

## Operation Controls

---

- [Radiographic table](#) on page 16
- [Radiographic wall stand](#) on page 17
- [X-ray tube head unit](#) on page 18
- [MUSICA Acquisition Workstation \(NX\)](#) on page 20
- [Software Console](#) on page 21
- [DR Detector Switch](#) on page 22
- [X-ray generator mini console \(Spellman\)](#) on page 23
- [Manual collimator](#) on page 25
- [Portable DR detector](#) on page 26
- [Emergency stop button](#) on page 27
- [Emergency shutdown power switch](#) on page 28
- [Power off behaviour](#) on page 29

## Radiographic table

The radiographic table is used for positioning of the patient lying or sitting over the detector in the bucky for exposure.

The radiographic table supports the patient and the detector for free exposure.

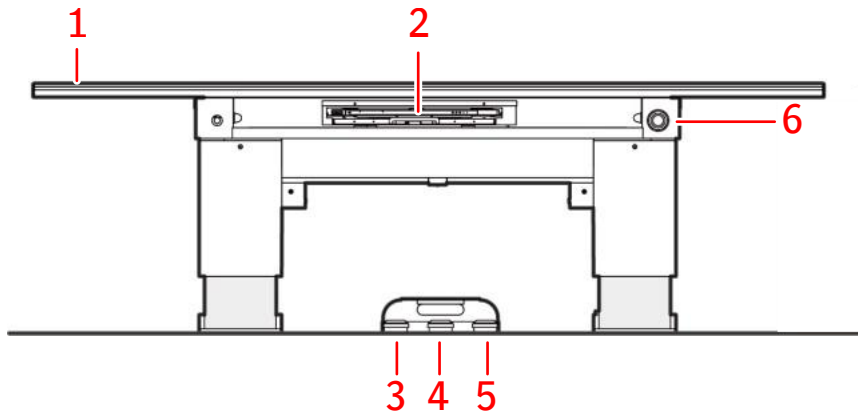

1. Floating tabletop
2. Bucky
3. Foot pedal to lower the table height
4. Foot pedal to release the brake for the floating tabletop
5. Foot pedal to raise the table height
6. Emergency stop button

**Figure 2: Radiographic table with motorized movement**

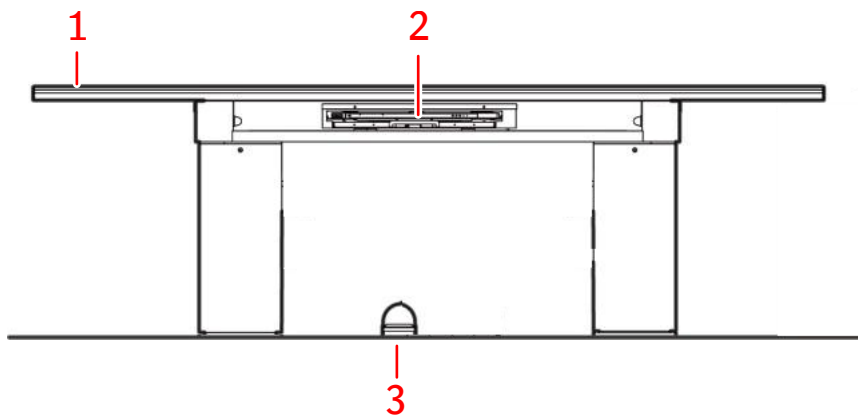

1. Floating tabletop
2. Bucky
3. Foot pedal to release the brake for the floating tabletop

**Figure 3: Radiographic table with fixed height**

### Related information

[Positioning the Radiographic Table](#) on page 114

[Radiographic Table Accessories](#) on page 117

[Radiographic Table Technical Data](#) on page 159

## Radiographic wall stand

The radiographic wall stand is used for positioning of patients standing upright or sitting towards the bucky for exposure.

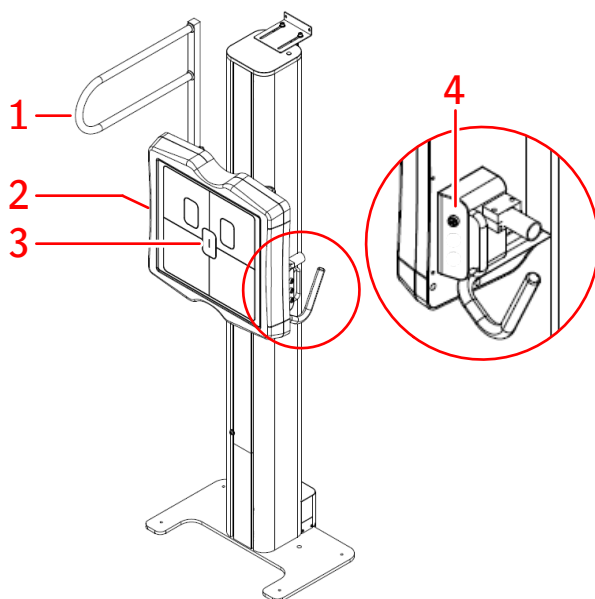

1. Lateral arm rest
2. Bucky unit
3. Indicators for the position of the AEC cells
4. Button to release the manual vertical movement

**Figure 4: Radiographic wall stand with manual movement**



**Caution:** The format indications on the front of the bucky unit show the format and position of the DR detector. Take into account that the actual area for imaging is smaller than indicated. The image of the exposed object is slightly magnified because there is a distance between the DR detector and the front of the bucky unit. The sensitive area of the DR detector may be slightly smaller than the indicated area. Check the technical data of the DR detector for exact values.

### Related information

[Positioning the Radiographic Wall Stand](#) on page 121

[Radiographic Wall Stand Accessories](#) on page 121

[Wall stand technical data](#) on page 160

## X-ray tube head unit

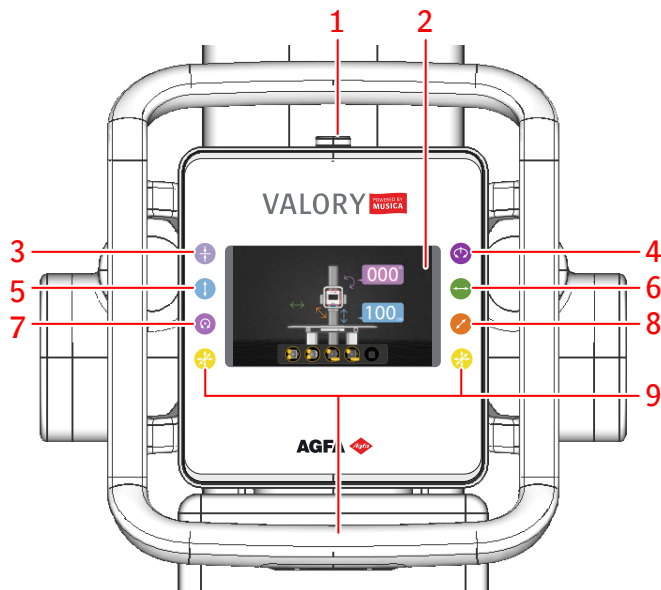

1. Emergency stop button
2. Tube head display showing positioning parameters and status information.

3.



**Figure 6: Position tracking button**

Activate/deactivate automatic centering and position tracking of the radiographic table.

Enable/disable a stop position at the center of the radiographic wall stand.

4.



**Figure 7: Beta rotation button**

Release the brake for rotating the X-ray tube around a vertical axis (beta rotation).

A stop position for centering on the radiographic wall stand is enabled if the position tracking button has been pushed.

5.



**Figure 8: Vertical movement button**

Release the brake for movement in vertical direction (up & down).

6.



**Figure 9: Longitudinal movement button**

Release the brake for movement in longitudinal direction (left & right).

There are stop positions for default SID on the radiographic wall stand.



**Figure 10: Tilting button**

Release the brake for tilting of the X-ray tube (alpha rotation).



**Figure 11: Transversal movement button**

Release the brake for movement in transversal direction (back & forth).

There are stop positions for centering on the radiographic table and on the radiographic wall stand.



**Figure 12: Omni-direction movement button**

Release the brake for movement in transversal, vertical and longitudinal direction.

### **Figure 5: X-ray tube head unit**

#### **Related information**

[Positioning the X-Ray Tube](#) on page 108

## MUSICA Acquisition Workstation (NX)

The MUSICA Acquisition workstation is used to define patient information, select exposures and process images.

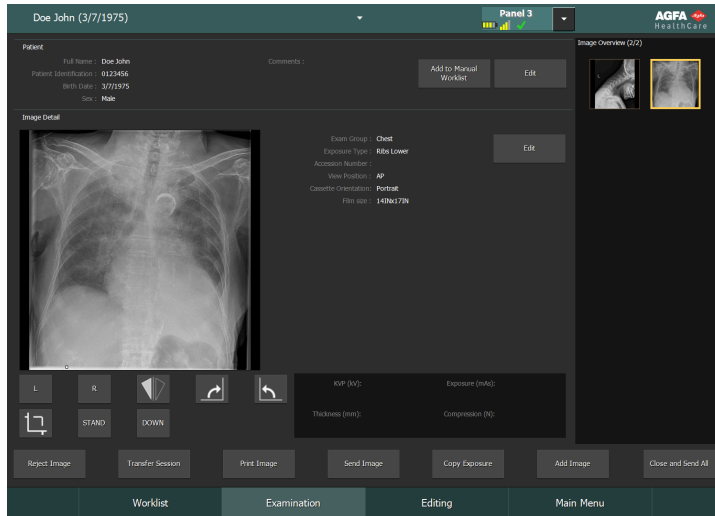

**Figure 13: MUSICA Acquisition workstation software**

The operation of the workstation application is described in the MUSICA Acquisition Workstation User Manual, document 4420.

The software is further referred to as "NX" and the PC on which it runs the "NX workstation".

## Software Console

The Software Console is available to support X-ray exposure and position parameter control on the NX workstation. It is displayed on the NX workstation next to the NX application.

The Software Console is used to control the X-ray exposure settings.

The Software Console contains the DR Detector Switch.

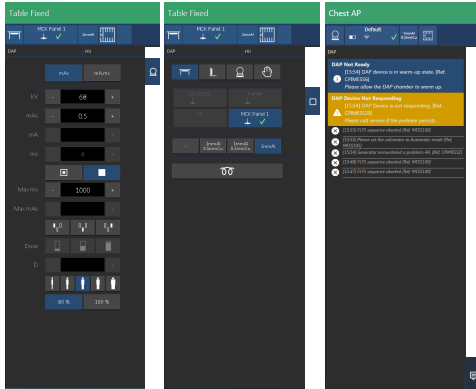

**Figure 14: Software console controls for generator, X-ray modality and system messages**

### Related information

[Software Console](#) on page 84

## DR Detector Switch

The DR Detector Switch shows which DR Detector is active and shows its status. The DR Detector Switch can be used to activate another DR Detector.

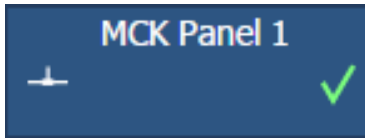

**Figure 15: DR Detector Switch**

## X-ray generator mini console (Spellman)

The X-ray generator mini console is available in the operator room.

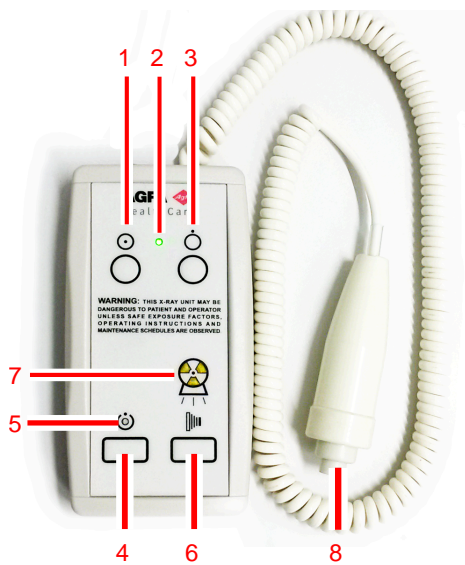

1. Power ON button
2. Power ON indicator
3. Power OFF button
4. Press and hold to prepare for exposure
5. Prepare ready indicator
6. Press and hold to start the exposure
7. Radiation indicator
8. Exposure button

**Figure 16: X-ray generator mini console**

### Exposure button

#### Preparing for exposure

Press the exposure button down to the first pressure point and hold it for approximately 0.5 s to 2 s.



The X-ray tube is prepared for performing an exposure.



**Caution:** Wear of X-ray tube due to prolonged preparing of the X-ray tube.

#### Starting the exposure

Before starting the exposure:

1. Check if the exposure settings displayed on the console are suitable for the exposure.
2. Check the Ready for Exposure status.

Press the exposure button down fully and keep it pressed until the exposure has ended.



The radiation indicator on the control console lights up and a signal sounds to indicate the exposure.



**Caution:** Releasing the exposure button ends the exposure immediately and the image can be underexposed.

## Manual collimator

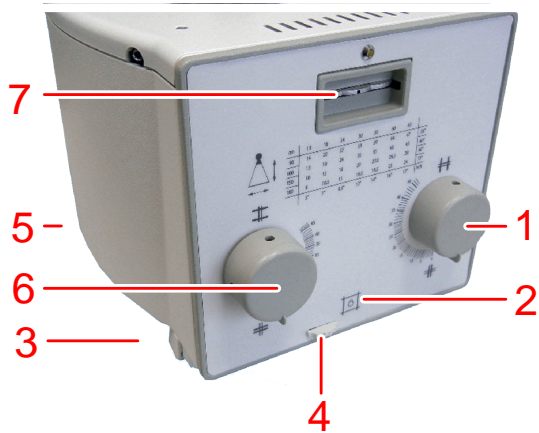

1. Longitudinal collimation
2. Button to switch on the light field indicating the collimated area and the laser light indicating the center position.

After pressing the button, they remain lit for half a minute before automatically switching off.

3. Rails to insert a DAP meter or a filter.
4. Switch to shield the laser light.
5. Measurement tape to measure the source image distance (SID).

The measurement tape is at the rear side of the collimator.

6. Transversal collimation
7. Filter selection.

Filter indicator.

**Figure 17: Manual collimator**



### Related information

[Manual Collimator Technical Data](#) on page 167

## Portable DR detector

When performing an exposure, keep in mind the following detector orientation aids:

**Table 1: Orientation aids**

	Tube side icon, indicating the side that faces the X-ray tube
	Patient orientation marker, filled rectangle printed at the corner of the detector, for consistent orientation relative to the patient

For an overview of the operation controls of the DR detector, refer to the user manual of the DR detector.

The DR detector may come in contact with the patient.



**Note** DR detectors that operate wireless contain an RF transmitter. For detailed information, refer to the DR detector user manual.

## Emergency stop button

If a system malfunction causes an emergency situation involving the patient, operating personnel or any system component, activate the emergency stop button.

Multiple emergency stop buttons are available on the system.

- On the front side of the radiographic table (right)
- On the top side of the X-ray tube head unit

All motor driven movements will be stopped. (Radiographic table)

A message is shown on the tube head display.

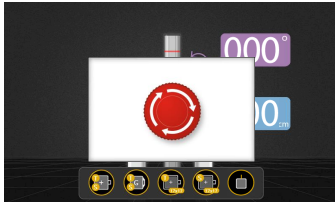

**Figure 18: Message on the tube head display**



**Caution:** The emergency stop button does not switch off the voltage in the X-ray system.

To allow motorized movements again, turn the cap of the emergency stop button in clockwise direction (default position).



**Warning:** When turning the switch clockwise to recover the equipment from the emergency stop status, pay attention to make sure that the equipment is not moving abnormally. If the system moves abnormally again, stop the system immediately using the emergency stop button.

## Emergency shutdown power switch

Use the emergency shutdown power switch, if a dangerous situation cannot be eliminated by pressing the emergency stop button.



**Warning:** Use the emergency shutdown power switch in case of danger to patients, operators, third parties, or one of the units. The entire system will be shut down and the power supply will be disconnected.

The emergency shutdown power switch for the room is typically located on the wall and easy to access, often close to the power off switch of the X-ray system. It is installed and labeled by customer.



**Warning:** It must be ensured that the emergency switches are always freely accessible.

## Power off behaviour

After the system is stopped or if the emergency stop button is activated, the brakes on the moving parts are activated.



**Warning:** The brakes of the floor mounted column with X-ray tube head are activated. If the X-ray tube head makes it impossible for the patient to step down from the table, the X-ray tube head can be moved when sufficient force is applied.

Moving the X-ray tube head when the power is off, can cause damage to the equipment.

## Installation

---

Installation and configuration is performed by an Agfa trained and authorized service engineer. Contact your local support organization for more information.

On a configuration with multiple DR detectors of the same type, it is required to apply labeling to the DR detector containing a unique nickname for each DR detector. The nicknames must be configured on the MUSICA Acquisition Workstation. The **DR Detector Switch** shows which DR detector is active and shows its status, by means of the nickname of the DR detector.

An identical label is attached to the bucky of the X-ray system to identify the dedicated workspace of each DR detector.

- [HF-emission and immunity](#) on page 30

### HF-emission and immunity

The HF-emission and immunity can be influenced by connected data cables depending on length and the manner of installation.

A specific installation environment may require special measures to put the system into operation according to the remarks for HF-emission and immunity.

#### Related information

[Remarks for HF-emission and immunity](#) on page 172

## Radiation Protection

---

X-ray radiation can cause serious damage to the health, therefore observe great care and ensure that protection against X-ray exposure is always applied.

Some of the effects of X-ray radiation are cumulative and may extend over a period of time. Therefore the X-ray operator should avoid exposure by X-ray radiation at all times.

Objects in the path of the X-ray beam may produce scattered radiation. The intensity depends on the energy and intensity of the X-ray exposure, the material of the object and the distance to the object producing scattered radiation. Protective measures have to be taken to prevent exposure through scattered radiation.

Protective measures include:

- structural configuration of the X-ray room (e.g. lead shielded rooms)
- radiation protection for the operators (e.g. personal radiation dosimeters, lead aprons, radiation protection glasses, mobile lead screens, keep maximum distance from X-ray source and from the object producing scattered radiation, regular training, etc.)
- protection of patients against unnecessary radiation (e.g. limitation of X-ray field by collimation, lead shielding, lead aprons, etc.)
- [Monitoring of Personnel](#) on page 32
- [Protected area and significant zones of occupancy](#) on page 33
- [Guidelines for Pediatric Applications](#) on page 38
- [Effect of SID on patient dose](#) on page 39

## Monitoring of Personnel

The monitoring checks the amount of X-ray radiation the personnel has been exposed to. It determines safety of the operators and it helps checking if safety measures of the X-ray environment are adequate. Inadequate or improper protection can lead to serious damage to the health.

To measure radiation, personal radiation dosimeters are typically used. They are worn on the body at all times during working in an environment where X-ray radiation is applied. They provide an indication for the amount of radiation the operator was exposed to.

## Protected area and significant zones of occupancy

If the operator or staff does not need to be close to the patient during the exposure, the operator and staff use the protected area to control the following functions:

- selection of mode of operation
- selection of exposure settings (X-ray loading factors)
- actuation of the exposure button
- other necessary controls for the operator during exposure

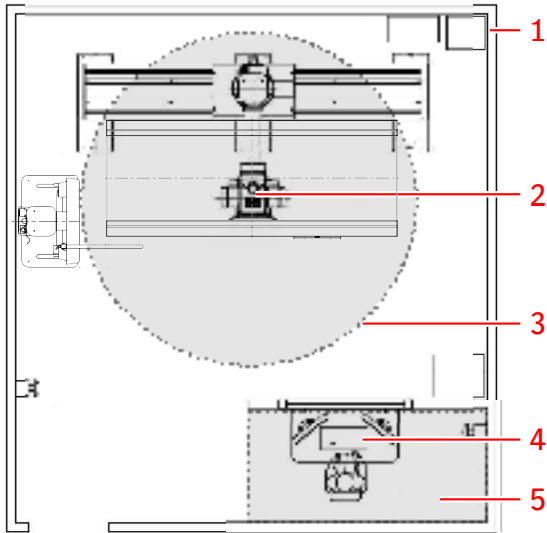

1. X-ray room
2. X-ray tube
3. Patient environment
4. Workstation
5. Operator room: protected area

**Figure 19: Protected area and significant zones of occupancy**



**Warning:** The patient must wear appropriate radiation protection garments.

The position of the patient environment depends on the position of the X-ray tube.

### Significant zones of occupancy at the radiographic table

If operator or staff needs to be close to the patient during normal use (e.g. some pediatric examinations or types of examinations for which the patient requires assistance or procedures that require the physician to be present next to the patient), the significant zone of occupancy applies for operator and staff.

Keep maximum distance from the X-ray source and from the object producing scattered radiation. The intensity of scattered radiation depends on the energy and intensity of the X-ray exposure, the material of the object and the distance to the object.



**Warning:** The patient and the operator must wear appropriate radiation protection garments.

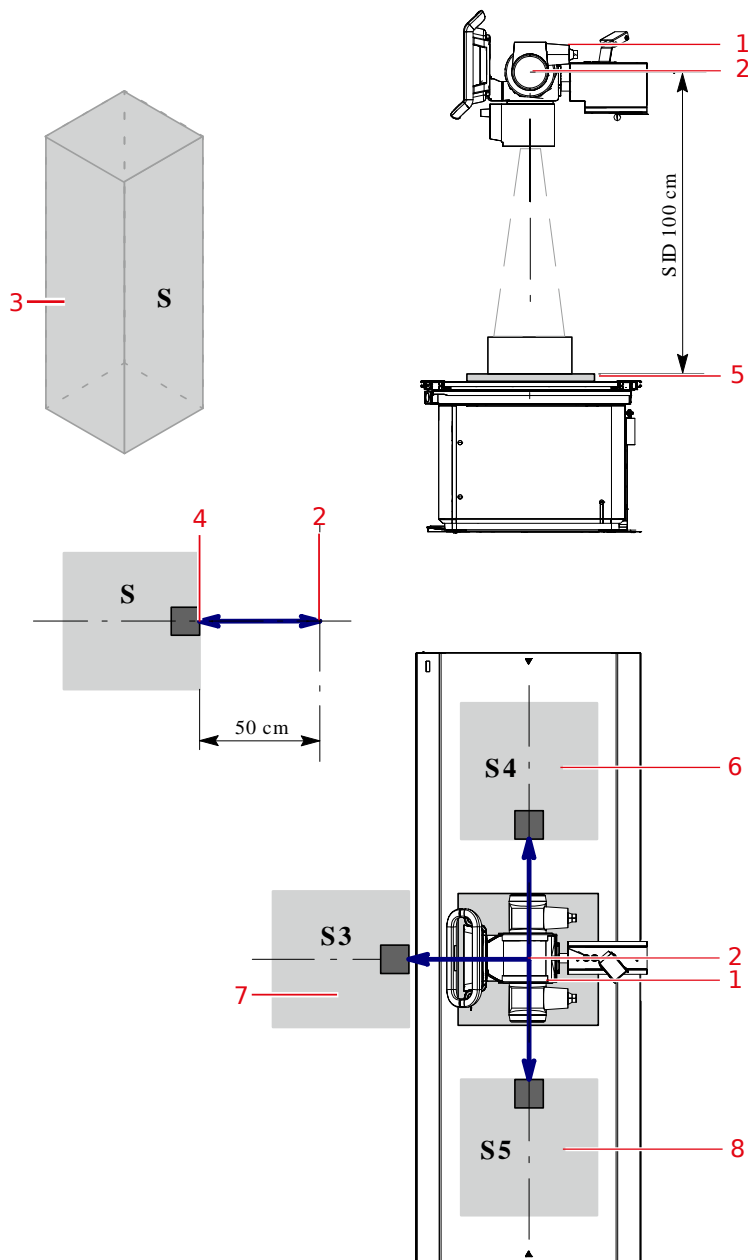

1. X-ray tube
2. Focal spot label [—]
3. Significant zone of occupancy.  
Minimum area 60x60 cm.  
Minimum height above the floor 200 cm.
4. Dose meter
5. DR Detector or cassette
6. Significant zone of occupancy at the left side of the radiographic table
7. Significant zone of occupancy in front of the radiographic table
8. Significant zone of occupancy at the right side of the radiographic table

**Figure 20: Significant zones of occupancy at the radiographic table**

### Significant zones of occupancy at the radiographic wall stand

If operator or staff needs to be close to the patient during normal use (e.g. some pediatric examinations or types of examinations for which the patient requires assistance or procedures that require the physician to be present next to the patient), the significant zone of occupancy applies for operator and staff.

Keep maximum distance from the X-ray source and from the object producing scattered radiation. The intensity of scattered radiation depends on the energy and intensity of the X-ray exposure, the material of the object and the distance to the object.

**Warning:** The patient and the operator must wear appropriate radiation protection garments.

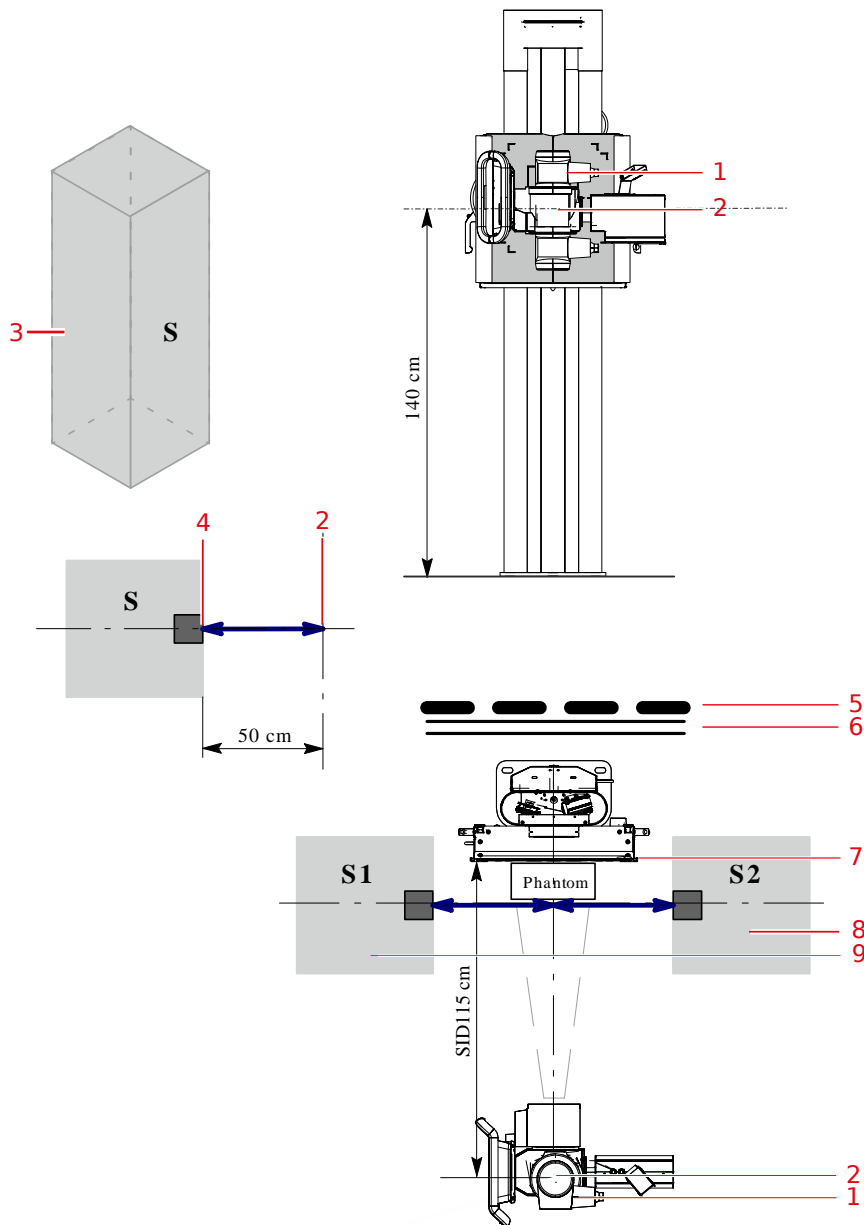

1. X-ray tube
2. Focal spot label [—]
3. Significant zone of occupancy.

Minimum area 60x60 cm.

Minimum height above the floor 200 cm.

4. Dose meter
5. Protective device
6. Wall
7. DR Detector or cassette
8. Significant zone of occupancy at the right side of the radiographic wall stand
9. Significant zone of occupancy at the left side of the radiographic wall stand

**Figure 21: Significant zones of occupancy at the radiographic wall stand**

#### Stray radiation

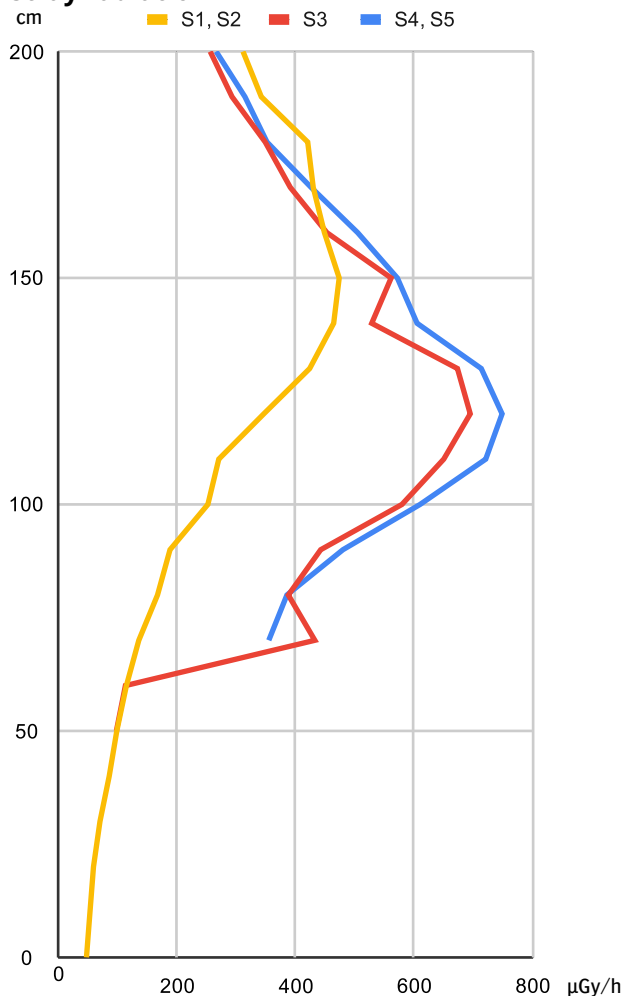

**Figure 22: Measurement of stray radiation in zones of occupancy for height range 0 to 200 cm from the floor**

**Table 2: Conditions for measuring stray radiation values represented in the illustrations**

Object	25 cm x 25 cm x 15 cm water
SID	100 cm
Exposure parameters	100 kV, 63 mAs
Collimation	18 cm x 18 cm
Table height (S3, S4, S5)	70 cm

Bucky center height (S1, S2)	140 cm
------------------------------	--------

For the diagram above a maximum throughput of 30 exposures/hour was used. This complies with a throughput of 15 patients/hour with typically 2 exposures done per patient. The measurement results in the figure above refer to one exposure.

## Guidelines for Pediatric Applications



**Caution:** Use special care when imaging patients outside the typical adult size and weight range. Children are more radiosensitive than adults.

Reducing dose for radiographic procedures while maintaining acceptable clinical image quality will benefit patients. The user documentation of this product contains a set of guidelines for pediatric applications, applicable in the U.S.A. Refer to document "Exposure Techniques for pediatric and adult use with Valory".

Adopting the Image Gently campaign guidelines and reducing dose for radiographic procedures while maintaining acceptable clinical image quality will benefit patients. Please review the following link and reduce pediatric technique factors accordingly: <http://www.imagegently.org>

As a general rule, next recommendations shall be observed in pediatrics:

- X-Ray Generator must have short exposures times.
- AEC must be used carefully, preferably use manual technique setting, applying lower doses.
- If possible, use high kVp techniques.

**Positioning the pediatric patient:** Pediatric patients are not as likely as adults to understand the need to remain still during the procedure. Therefore it makes sense to provide aids to maintaining stable positioning. It is strongly recommended the use of immobilizing devices such as bean bags and restraint systems (foam wedges, adhesive tapes, etc.) to avoid the need of repeating exposures due to the movement of the pediatric patients. Whenever possible use techniques based on the lowest exposure times.

**Shielding:** We recommend you provide extra shielding of radiosensitive organs or tissues such as eyes, gonads and thyroid glands. Applying a correct collimation will help to protect the patient against excessive radiation as well. Please review the following scientific literature regarding pediatric radiosensitivity: GROSSMAN, Herman. "Radiation Protection in Diagnostic Radiography of Children". *Pediatric Radiology*, Vol. 51, (No. 1): 141--144, January, 1973:

<http://pediatrics.aappublications.org/cgi/reprint/51/1/141>.

**Technique factors:** You should take steps to reduce technique factors to the lowest possible levels consistent with good image acquisition and to limit the duration of fluoroscopy sequences and rapid sequences.

For example if your adult abdomen settings are: 70--85 kVp, 200--400 mA, 15--80 mAs, consider starting at 65--75 kVp, 100--160 mA, 2.5--10 mAs for a pediatric patient. Whenever possible use high kVp techniques and large SID (Source Image Distance).

**Summary:**

- Image only when there is a clear medical benefit.
- Image only the indicated area.
- Use the lowest amount of radiation for adequate imaging based on size of the child (reducing tube output -- kVp and mAs, limiting the duration of dynamic imaging).
- Try to use always short exposure times, large SID values and immobilizing devices.
- Avoid multiple scans and use alternative diagnostic studies (such as ultrasound or MRI) when possible.

## Effect of SID on patient dose

Changing the distance of the X-ray tube to the patient affects the dose applied to the patient.











For example doubling the distance reduces the dose by a factor of 4. The new dose can be calculated by a formula:







$$\text{new mAs} = \text{known mAs} \times \left( \frac{\text{new distance}^2}{\text{old distance}^2} \right)$$



**Caution:** The distance of the X-ray tube to the patient cannot be less than 45 cm.

## Labels

Symbol	Explanation
	General warning, caution, risk of danger.
	Read and understand all instructions and warning labels in the product documentation before using the equipment. Keep manual for future reference.
	Ionizing radiation
	Dangerous voltage
	Pinch Points
	Hot Surface Warning Indicates that touching the part indicated can cause burns.
	Laser Warning Indicates the presence of a laser device.
	Do not sit Warning Indicates that sitting on a component can cause damage to the equipment.
	Alternating current
	Protective earth (ground)
	On (power: connection to the mains)
○	Off (power: disconnection from the mains)
	Type B applied part









Symbol	Explanation
	Manufacturer
	Date of manufacture
	Serial number
	This mark shows compliance of the equipment with Regulation 2017/745 (for European Union).
	This symbol on the products, and/or accompanying documents means that used electrical and electronic products should not be treated as, or mixed with general household waste.
	The most recent version of this document is available on <a href="http://www.agfahealthcare.com/global/en/library/index.jsp">http://www.agfahealthcare.com/global/en/library/index.jsp</a>
	Pollution Control. (Only applicable to People's Republic of China (PRC)). This symbol indicates the product contains hazardous materials in excess of the limits established by the Chinese Standards. It must not be disposed of as unsorted municipal waste and must be collected separately. Please contact an authorized representative of the manufacturer or an authorized waste management company for information concerning the decommissioning of your equipment.

- [Warning labels on the radiographic table](#) on page 42
- [Warning labels on the radiographic wall stand](#) on page 43
- [Warning labels on the floor mounted column and tube head unit](#) on page 44
- [Type label](#) on page 45
- [Additional labeling of the radiographic table](#) on page 46
- [Additional labeling of the radiographic wall stand](#) on page 47
- [Additional labeling of the floor mounted column and tube head unit](#) on page 48
- [Additional labeling of the main control box](#) on page 49
- [Labeling of the X-ray generator mini console](#) on page 50
- [Type labels of accessories](#) on page 51
- [DR Detector identification label](#) on page 53
- [About the software](#) on page 54

## Warning labels on the radiographic table



Figure 23: Warning labels on the radiographic table

1		<b>Warning</b> Falling hazard. To avoid injuries, be alert when the patient is getting on or off the table.
2		<b>Danger</b> Do not sit on the edge of the table. It may cause severe injury due to the movement of the table.
3		<b>Warning</b> Pinch point. Keep hand and fingers away from this area.
4		<b>Warning</b> Risk of electrical shock. Disconnect the power supply of the equipment prior to inspection or maintenance.
5		<b>Danger</b> Never disassemble or let an unauthorized person modify and/or repair the product.
6		<b>Caution</b> Read and understand the user manual before operating this equipment.
7		Maximum load capacity is 10 kg on the bucky drawer when it is pulled out. Do not lean or sit on the bucky.
8		<b>Caution</b>

## Warning labels on the radiographic wall stand

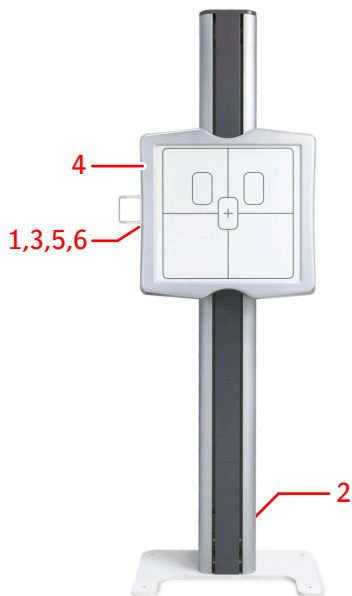





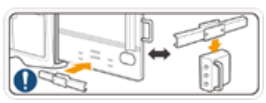

Figure 24: Warning labels on the radiographic wall stand

1		<b>Warning</b> Pinch point. Keep hand and fingers away from this area.
2		<b>Danger</b> Never disassemble or let an unauthorized person modify and/or repair the product.
3		<b>Caution</b> Read and understand the user manual before operating this equipment.
4		Do not apply a weight of more than 20 kg to the lateral arm rest.
5		Maximum load capacity is 10 kg on the bucky drawer when it is pulled out. Do not lean or sit on the bucky.
6		When the detachable clamp is not used, it can be stored by attaching it magnetically at the rear side of the wall stand bucky.

## Warning labels on the floor mounted column and tube head unit

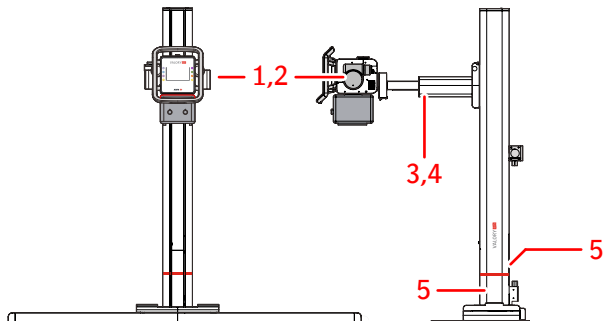





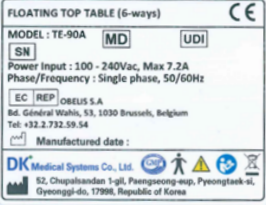

Figure 25: Warning labels on the floor mounted column and tube head unit

1		<b>Warning</b> This X-ray equipment may be hazardous to patient or operator, unless following the safe radiation conditions and the operating instructions.
2		<b>Warning</b> Hot surface.
3		<b>Warning</b> Pinch point. Keep hand and fingers away from this area.
4		<b>Caution</b> Read and understand the user manual before operating this equipment.
5		Never disassemble or let an unauthorized person modify and/or repair the product. The label is located at the foot of the column.



## Additional labeling of the radiographic table

	<p>Top side according to patient orientation to indicate the orientation of the AEC sensors (optional)</p>
 <p><b>Figure 27: Example of component type label</b></p>	<p>Original manufacturer type label on a system component.</p>

## Additional labeling of the radiographic wall stand



**Figure 28: Example of component type label**

Original manufacturer type label on a system component.

### Additional labeling of the floor mounted column and tube head unit

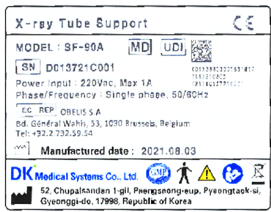
 <p><b>Figure 29: Example of component type label</b></p>	<p>Original manufacturer type label on a system component.</p>
--	--

## Additional labeling of the main control box



 <p>The image shows a rectangular label for a 'Main Control Box'. The label contains the following text: 'Main Control Box', 'MODEL : MCBA', 'SN J131622E002', 'Power Input : 220Vac, Max 5.7A', and 'Phase/Frequency : Single phase, 50/60Hz'. Below this is a 'Manufactured date : 2022.05.26'. At the bottom, there is a logo for 'DK Medical Systems Co., Ltd.' and the address '52, Chupalsandan 1-gil, Paengsaeng-eup, Pyeongsok-si, Gyeonggi-do, 17998, Republic of Korea'. There are also several small icons including a CE mark, a triangle with an exclamation mark, and a triangle with a lightning bolt.</p>	<p>Original manufacturer type label on a system component.</p>
--	--

**Figure 30: Example of component type label**

**Labeling of the X-ray generator mini console**

	If the system has just been stopped, wait at least 10 seconds before starting it again.
---	---

## Type labels of accessories

Mark	Meaning
 <p><b>Figure 31: Example of type label</b></p>	Patient hand grips for the radiographic table
 <p><b>Figure 32: Example of type label</b></p>	Lateral detector holder
 <p><b>Figure 33: Example of type label</b></p>	Compression belt
 <p><b>Figure 34: Example of type label</b></p>	Patient hand grips for the radiographic wall stand
 <p><b>Figure 35: Example of type label</b></p>	Lateral arm rest
 <p><b>Figure 36: Example of type label</b></p>	Storage box for DR detector and grids



Mark	Meaning
 <p>Foot Switch (3 Button)</p> <p>MODEL : F838</p> <p>DK K0460211001</p> <p>127 DC LVLC</p> <p>IPX1</p> <p>Manufactured date : 2021.06.28</p> <p>DK Medical Systems Co., Ltd.</p> <p>30, Cheonghwan-dae 1-gil, Ponggyong-myeon, Posaeng-gun, Gyeonggi-do, 17888, Republic of Korea</p>	Foot pedals

Figure 37: Example of type label

**DR Detector identification label**

Label	Meaning
	Writable label to identify and dedicate a DR Detector to an X-ray system bucky.

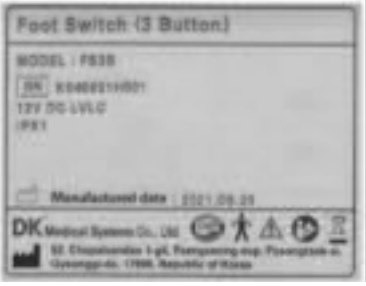
## About the software

NX has an About box, showing information on version and release of NX and other software on the NX workstation. To consult the About box, click **About NX...** in the Tools section of the Main Menu.



**Figure 38: Example of the NX About box**

## Cleaning and disinfecting

---

All appropriate policies and procedures should be followed to avoid contamination of the staff, patients and equipment. All existing universal precautions should be extended to avoid potential contaminations and to avoid patients coming into (close) contact with the device. Cleaning agents and disinfectants should only be used by trained people, who have the required knowledge to complete the cleaning and disinfecting task in a safe and effective way. If the system is used in an environment where disinfection is required or where it may get into contact with blood or other body fluids, use covers or sheaths to protect the system from direct patient contact. Only use legally marketed protective covers. The user is responsible for selecting a disinfection procedure.

1. Position the system such that the parts that must be cleaned or disinfected are easily accessible.
2. Stop the system



**Warning:** When the equipment is going to be cleaned, be sure to turn off the main power of the system. Never use anhydrous or high solvency alcohols, benzine, thinner or any other flammable cleaning agent. Otherwise, it may result in fire or electric shock.

3. Wipe the exterior of the system with a low-linting cloth slightly moistened with a neutral detergent.



**Caution:** Make sure no liquid gets in the device.



**Caution:** Liquids ingressing the DR Detector or the battery may cause malfunction and contamination. Take special care near the battery bay and near the cable connector on the side of the DR Detector.



**Caution:** Clean the equipment with only a little moisture. Do not spray disinfectants or detergents directly on the equipment. Do not pour liquid directly on the equipment.



**Caution:** Do not use solvents such as anhydrous or high solvency alcohols, thinner or benzine. Do not use any corrosive, dissolving or abrasive cleaning or polishing detergents. Doing so may damage the surface of the equipment. Using unsuitable cleaning agents or methods can damage the property when surface becomes dull and brittle (e.g. by using alcohol-containing agents).

Do not open the equipment for cleaning. No components inside the device require cleaning by the user.

4. Wipe the exterior of the system with a dry low-linting cloth or a cloth slightly moistened with water, to remove all cleaning agent residue.

Let all surfaces dry.

5. Perform a visual inspection of the exterior of the system.

The room must be sufficiently illuminated to perform the visual inspection.

Check for deterioration such as corrosion, cracks or serious discolorations, for damage to the cables or cable jackets, for loos screws.

Make sure that the accessories for immobilizing the patient haven't come loose.

If there's still dirt or cleaning agent residue, repeat the cleaning.

6. Disinfect all parts of the system which are contaminated or frequently touched by the user or the patient.

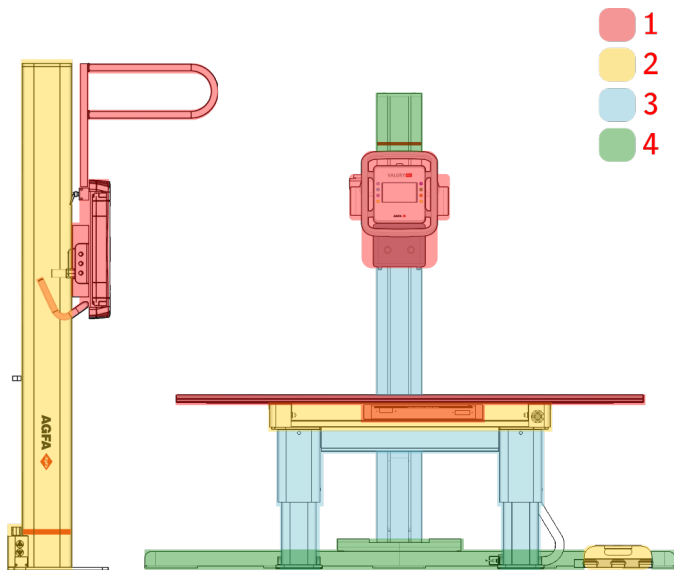

1. Very often
2. Regularly
3. Rarely
4. Almost never

**Figure 39: How frequently are parts of the system touched?**



**Warning:** To disinfect the device, use only disinfectants and disinfection methods that are approved by Agfa and that correspond to the national regulation and guidelines as well as explosion protection.

Refer to the Agfa website for specifications on the disinfectants that have been found compatible with the cover material of the device and can be used on the outer surface of the device.

<http://www.agfahealthcare.com/global/en/library/overview.jsp?ID=41651138>

If you plan to use other disinfectants, approval of Agfa is needed before use, as most disinfectants can damage the device. UV disinfection is also not allowed. Do not use any corrosive, soluble or gaseous disinfectants.

Consult the manufacturer's Material Safety Data Sheets (MSDS) and recommendations on the product label for additional information prior to use.



**Warning:** Using a disinfectant that can form an explosive or flammable gas mixtures is hazard to life and health because of explosion risk. Switch the equipment off before disinfecting. Allow the gas mixture to evaporate before switching the x-ray system back on.

- a) Perform the disinfecting procedure following the instructions for use, the disposal instructions and the safety instructions of the selected disinfectants and tools and of the hospital.

Use of spray disinfection can cause malfunctions due to ingress of the disinfectant into the equipment. Disinfect all parts of the unit, including the accessories and connection cables by just wiping them. Switch off the system and cover the cooled system carefully before performing a room disinfection using nebuliser.

Items contaminated with blood or body fluids, which may contain blood-borne pathogens, should be cleaned and then receive intermediate level disinfection with a product having an EPA-registered claim for activity against hepatitis B.



**Caution:** Using unsuitable disinfectants can cause discoloration and damage of the surface of the equipment. If a functional degradation or malfunctioning of the product is noticed due to disinfection, contact the medical device manufacturer.

- b) Wipe the exterior of the system with a dry low-linting cloth or a cloth slightly moistened with water, to remove all disinfectant agent residue.

Let all surfaces dry.

- c) Perform a visual inspection of the exterior of the system.

The room must be sufficiently illuminated to perform the visual inspection.

Check for deterioration such as corrosion, cracks or serious discolorations, for damage to the cables or cable jackets, for loos screws.

Make sure that the accessories for immobilizing the patient haven't come loose.

If there's still disinfecting residue, repeat the cleaning.

- 7. Start up the system.

Perform the checks that are required before operating the system.

## Maintenance

---

Complete maintenance schedules are available in the Agfa service documentation for consultation by an Agfa trained and authorized service engineer.







### Maintenance of the DR Detector

The DR Detector requires regular calibration. Calibration instructions are described in the DR Detector Calibration Key User Manual (doc 0134).

- [Maintenance actions](#) on page 59
- [Checklist before and after operation](#) on page 61
- [Checklist for the floor mounted column and tube head unit](#) on page 63
- [Checklist for the radiographic table](#) on page 64
- [Checklist for the radiographic wall stand](#) on page 65

## Maintenance actions

The X-ray unit and all components require regular maintenance to ensure the equipment is safe and reliable for operation.

-  **Warning:** Operation in unsafe condition includes the risk of radiological exposure and injury of the patient and/or the operator. The customer is responsible to ensure the fault-free condition of the equipment.
-  **Warning:** Wear of equipment due to excessively long intervals between service may lead to personal injury and property damage due to worn and unsafe parts.
-  **Warning:** If lubricating oil is not applied periodically (once a year), the tabletop may fail to function.
-  **Warning:** Incorrect or defective spare parts may adversely affect the safety of the system and lead to damages, malfunctions or total failure. Use only original spare parts provided by the manufacturer.
-  **Warning:** Improper changes, additions, maintenance or repair of the equipment or the software can lead to personal injury, electrical shock and damage to the equipment. Safety is only guaranteed when changes, additions, maintenance or repairs are carried out by an Agfa certified field service engineer. A non certified engineer performing a modification or service intervention on a medical device, acts on his own responsibility and makes the warranty void.
-  **Caution:** Keep the equipment and its environment clean, to prevent dust or dirt to accumulate.
-  **Caution:** In case of functional defects or other deviations from normal operation behavior the unit has to be switched off immediately and the service to be informed. The equipment must only be put back into operation when the fault has been repaired.

**Table 3: Lifetime and maintenance**

<b>Lifetime</b>	
Expected lifetime for the X-ray unit	10 years
<b>Periodic maintenance</b>	
An Agfa trained and authorized service engineer shall perform a technical maintenance according to the maintenance schedules in the service documentation, to maintain fault-free operation and ensure safety for patient and operator.	Every 12 months
Perform electrical safety testing according to IEC 62353	Every 36 months
<b>Maintenance by the user</b>	
Check the room for safety and remove objects that are within the movement area of the system	Daily
Check constant smooth movements	Daily
Check ease of movements	Daily
Check secure release and locking of brakes	Daily
Check functioning of operating controls	Daily
Check markers and warning signs	Daily
Check the equipment for visual damage, deformation or dents	Daily

Check all electric cables and connections for moisture and make sure they're dry	Daily
Check all electric cables and connections for damage or broken cables.	Daily
Warm-up of X-ray tube	Daily
Conditioning of the X-ray tube	After the X-ray tube has not been used for more than a week
Conditioning of the X-ray tube	Before making exposures using voltages of 120 kV or higher

### Conditioning procedure for the X-ray tube

If the X-ray tube has not been used for more than a week or if exposure techniques are to be used with energies above 120 kV, it is recommended to perform the conditioning procedure for the X-ray tube.

A sequence of gradually increasing loads on the X-ray tube will cause a redistribution of the electrical charges inside the tube, which in turn will result in a stable output of the tube.

The procedure takes approximately 30 minutes.

1. On the software console, select the manual modality position.  
No image will be acquired on the NX workstation.



2. Select the three point radiographic working mode.



3. Set the radiographic parameters to 125 mA (current) and 100 ms (exposure time).
4. Select the large focal spot.



5. Take a sequence of exposures with the following kV values. Take one exposure per 30 seconds.

**Table 4: Sequence of exposures**

Time (minutes)	kV	Time (minutes)	kV	Time (minutes)	kV
0.0	50	4.0	90	8.0	130
0.5	50	4.5	90	8.5	130
1.0	60	5.0	100	9.0	140
1.5	60	5.5	100	9.5	140
2.0	70	6.0	110	10.0	150
2.5	70	6.5	110	10.5	150
3.0	80	7.0	120		
3.5	80	7.5	120		

## Checklist before and after operation

The user shall perform these checks before, during and after operating the system.

**Table 5: Checklist**

Check	Mitigation
<b>Before starting the system</b>	
Are unnecessary objects present near the equipment?	Remove unnecessary objects near the equipment.
Has an examination room been checked for safety?	Check if the room is safe.
Is there any equipment cable caught, twisted, or rubbing against other objects	Position/wire cables correctly.
Has any moisture been collected on a cable connector?	Dry the cable connectors.
Has any cable insulation been damaged?	Contact the manufacturer.
Is there any dent, crack or condensation visible on the equipment?	Contact the manufacturer.
Are all cables connected correctly?	Connect the cables correctly.
<b>After starting the system, before operation</b>	
Does the display flicker?	Contact service.
Is there any unusual smell?	Stop the system, and contact the manufacturer.
Does the system produce abnormal noises?	Stop the system, and contact the manufacturer.
Has conditioning been performed on the X-ray tube?	Perform conditioning of the X-ray tube.
Is there an error in the operation of the accessories?	Contact the manufacturer.
<b>After operation, before stopping the system</b>	
Does the display flicker?	Contact service.
Is there any unusual smell?	Stop the system, and contact the manufacturer.
Does the system produce abnormal noises?	Stop the system, and contact the manufacturer.
<b>After stopping the system</b>	
Are unnecessary objects present near the equipment?	Remove unnecessary objects near the equipment.
Has an examination room been checked for safety?	Check if the room is safe.
Is there any equipment cable caught, twisted, or rubbing against other objects	Position/wire cables correctly.
Has any moisture been collected on a cable connector?	Dry the cable connectors.

Check	Mitigation
Has any cable insulation been damaged?	Contact the manufacturer.
Is there any dent, crack or condensation visible on the equipment?	Contact the manufacturer.
Does the system need cleaning or disinfecting?	Perform cleaning and disinfecting.



**Caution:** In case of functional defects or other deviations from normal operation behavior the unit has to be switched off immediately and the service to be informed. The equipment must only be put back into operation when the fault has been repaired.

## Checklist for the floor mounted column and tube head unit

The user shall perform these checks before using the floor mounted column and tube head unit.

**Table 6: Checklist**

Check	Mitigation
<b>Before using the system</b>	
Do the rails show folding or damage?	Contact the manufacturer if a problem is detected.
Has dust collected on the rails?	
Does the movement in any direction produce abnormal noises?	
Do any of the brakes that stop movement behave incorrectly?	
Does the device behave abnormally in any way?	
Is there any malfunction on the control buttons?	

## Checklist for the radiographic table

The user shall perform these checks before using the radiographic table.

**Table 7: Checklist**

Check	Mitigation
<b>Before using the system</b>	
Is there any dent, crack or condensation visible on the tabletop or on the grid?	Contact the manufacturer if a problem is detected.
Does the brake that stops movement of the tabletop behave incorrectly?	
Does the movement of the tabletop behave jerky or creaky?	
Does the brake that stops movement of the bucky behave incorrectly?	
Does the movement of the bucky behave jerky or creaky?	
Can you feel resistance when pulling the bucky drawer in or out?	
Is the fixation of the DR detector in the bucky ineffective?	
Can you feel resistance when inserting or removing a grid?	
Is the fixation of the grid in the bucky ineffective?	
Is there any malfunction on the foot pedals?	
Is the movement irregular in any way?	

## Checklist for the radiographic wall stand

The user shall perform these checks before using the radiographic wall stand.

**Table 8: Checklist**

Check	Mitigation
<b>Before using the system</b>	
Is there any dent, crack or condensation visible on the tabletop or on the grid?	Contact the manufacturer if a problem is detected.
Does the brake that stops movement of the bucky behave incorrectly?	
Does the movement of the bucky behave jerky or creaky?	
Can you feel resistance when pulling the bucky drawer in or out?	
Is the fixation of the DR detector in the bucky ineffective?	
Can you feel resistance when inserting or removing a grid?	
Is the fixation of the grid in the bucky ineffective?	
Is there any malfunction on the control buttons?	
Is the movement irregular in any way?	

















## Safety Directions









---

- [General Safety Directions](#) on page 66
- [Safety Directions for the X-Ray System](#) on page 68
- [Safety Directions for the radiographic table](#) on page 69
- [Safety directions for the floor mounted column](#) on page 70

## General Safety Directions













---

-  **Warning:** Safety is only guaranteed when an Agfa certified field service engineer has installed the product.
-  **Warning:** Risk of heavy weight causing physical injury. The system components must be installed and used according to the instructions.
-  **Warning:** The rails of the floor mounted column may be an obstacle when moving around the system. Be careful not to trip over the rails. Falls could result in injury.
-  **Warning:** The product must only be installed using released components and in released configurations.
-  **Warning:** Unauthorized manipulation or opening of the equipment housing may lead to personal injuries and to property damage. Take all necessary precautions with respect to the applicable level of safety.
-  **Warning:** To avoid risk of electric shock, this equipment must only be connected to a supply mains with protective earth.
-  **Warning:** Do not use any power supply other than specified by Agfa for use with the equipment. Otherwise, it may result in fire or electric shock.
-  **Warning:** Do not connect the equipment with anything other than specified. Doing so may result in fire or electric shock.
-  **Caution:** Install the NX workstation at a minimum (safe) distance of 2 m from the X-ray system components or provide a wall or window to separate both systems.
-  **Warning:** To avoid risk of electric shock, do not remove any covers. Changes, additions, maintenance or repairs must be carried out by an Agfa certified field service engineer.
-  **Warning:** Even if the generator is switched off, parts on the inside of the generator cabinet and connected controls are still powered! Ensure that only trained service personnel open the generator cabinet and the housing of connected devices! Improper handling may cause a lethal hazard!
-  **Warning:** Do not place any objects on top of the equipment. The object may fall and cause an injury. Also, if metal objects such as needles, staples or clips fall into the equipment, or if liquid is spilled, it may result in fire or electric shock. If liquid or water flows into an electrical component, turn off the power, mark it as "Out of Order" and contact service.
-  **Warning:** The system is not intended for operation in explosion-prone areas. Such an operation is hazardous to life and health because of explosion risk. Please note the applicable regulations on formation of explosive gas mixtures when cleaning and using in combination with patients.
-  **Warning:** Operating the equipment when it is faulty includes the risk of radiological exposure and injury to the patient and to the operator. Operate the equipment only in safe and fault-free conditions.
-  **DANGER:** Make sure that no persons or objects are within the movement area of the system where they can collide with moving parts of the system.
-  **DANGER:** In case of uncontrolled movement of a motorized component, press the nearest emergency stop button and contact your local service organization.
-  **Warning:** Monitor the patient position (hands, feet, fingers, etc.) with special care to avoid injury to the patient caused by unit movements. Patient hands must be kept away from mobile components of the unit. Intravenous tubing, catheters and other patient connected lines should be routed away from moving equipment.

-  **Warning:** Make sure that no clothes of the patient or the operator get caught by moving parts of the system.
-  **Warning:** Portable and mobile HF communication devices may affect medical electrical equipment.
-  **Caution:** Excessive ambient temperature may impact performance of DR Detectors and cause permanent damage to the equipment. Refer to the related user manual for environmental conditions for the DR detector. If ambient temperature and humidity is outside the specified range, do not operate the system or use air conditioning. Frost due to low temperatures can damage internal circuits. Warranty will be void if it is obvious that operating conditions are not met.
-  **Caution:** Sudden heating of the room in cold areas will cause condensation to form on the equipment. In this case, wait until the condensation evaporates before use. If the equipment is used while condensation is formed on it, problems may occur. Condensation inside the equipment can cause rust and corrosion. When an air-conditioner is used, be sure to raise/lower the temperature gradually so that a difference in temperature in the room and in the equipment does not occur, to prevent condensation.
-  **Caution:** To avoid images being lost due to a power failure, use an uninterruptable power supply (UPS) or an institutional standby generator.
-  **Warning:** System unavailability due to hardware or software failure. If the product is used in critical clinical workflows, a backup system has to be foreseen.
-  **Caution:** Due to the length of high voltage cable, the X-ray tube head unit should not be rotated over more than  $\pm 180^\circ$ .
-  **Caution:** Strictly observe all warnings, cautions, notes and safety markings within this document and on the product.
-  **Caution:** All Agfa medical products must be used by trained and qualified personnel.

## Safety Directions for the X-Ray System

---

-  **Warning:** Ionizing radiation can lead to radiation injuries if handled incorrectly. When radiation is applied, the required protective measures must be complied with.
-  **Warning:** The operator must take precautions to protect himself against dangerous X-ray exposure when using the DR detector in the X-ray beam path of an X-ray source.
-  **Warning:** The DR Detector is not intended to be used as a primary barrier to X-rays. The user is responsible for ensuring the safety of the operator, bystanders, and the subjects being radiographed.
-  **Warning:** Repeated exposures to a patient with high doses can lead to deterministic effects. Therefore exposure settings shall be selected carefully and in accordance to the patient and the object to expose and balanced in such a way that patient dose is as low as possible while image quality is usable for diagnosis.
-  **Warning:** Using an inappropriate SID can result in a suboptimal or unusable image. Too short SID causes warped image.
-  **Warning:** The use of a filter that is not suitable for the type of examination can affect the image quality or the amount of radiation.
-  **Warning:** A wrongly inserted DR detector (e.g. upside down) will result in an unusable image.
-  **Warning:** Software failure causing delay in synchronization between DR detector and generator can result in an unusable image.
-  **Warning:** Damaged grid. Reduced image quality. Please handle the grids with special care.
-  **Warning:** When inserting the anti-scatter grids, it is essential that the grid corresponds to the intended source-image-distance (SID) to which the grid is focussed. Because of the focussing of the grids, the tube head unit must be centered onto the bucky.
-  **Caution:** Avoid unnecessary dose by checking before exposure if the DR Detector Switch displays the name of the DR Detector that is being used and if the status of the DR Detector is ready for exposure.
-  **Caution:** When operating the DR detector, the calculated exposure time (ms) or manual overrides should never exceed the maximum exposure time (Max ms) specified as integration time of the DR detector.

## Safety Directions for the radiographic table

---



**Warning:** Using soft covers, sheets, mattresses, etc. may lead to visual image artifacts. If such shall be used, make sure that they are x-ray transparent and do not influence image quality.



**Caution:** Make sure that the patient hand grips are securely mounted.

## Safety directions for the floor mounted column

---

If the radiographic table is installed in the movement range of the floor mounted column, make sure that the X-ray tube, collimator or X-ray tube arm do not collide with the tabletop, especially when the X-ray tube moves under the tabletop.

If the radiographic wall stand is installed in the movement range of the floor mounted column, make sure that the X-ray tube, collimator or X-ray tube arm do not collide with the radiographic wall stand.

## Basic Workflow

---

- [Starting the System](#) on page 71
- [Performing an exposure using the DR Detector](#) on page 73
- [Performing an exposure using a CR cassette](#) on page 79
- [Stopping the System](#) on page 84

## Starting the System

 **Warning:** Before making X-ray exposures, make sure that the system is functioning correctly and that all components and accessories are securely mounted.

Allow the DR detector to warm up before the system is used for clinical purposes. The warming-up time starts as soon as the DR detector has been powered on and the MUSICA Acquisition workstation is running. To check if a warming-up time is required, refer to the DR detector technical data.

To start the system:

1. Switch on the electrical room switch.  
Check that neither the emergency shutdown power switch for the system nor any of the emergency stop buttons is activated.
2. Press the Power ON button on the X-ray generator mini console to switch on the system.
3. Start the MUSICA Acquisition workstation.

For detailed information about starting up MUSICA Acquisition workstation, refer to the MUSICA Acquisition workstation User Manual, document 4420.

The NX application and the software console are available on the MUSICA Acquisition workstation.

4. Power on the DR detector:
  - a) attach a fully charged battery pack to the DR detector.
  - b) turn on the DR detector.
  - c) if needed, register the DR detector to the MUSICA Acquisition workstation.

For detailed information about starting up the DR detector, refer to the DR Detector User Manual.

- [Automated workflow for warming-up of X-ray tube](#) on page 71

### Automated workflow for warming-up of X-ray tube

The software console provides an automated workflow for warming-up of the X-ray tube.

1. Close the collimator blades fully.
2. Make sure that no one will be exposed.
3. On the software console, go to the screen with modality controls.



**Figure 40: Navigation button for modality controls**

4. Click the button to start the automated workflow for warming-up of the X-ray tube.

**Figure 41: Button to start the automated workflow for warming-up of the X-ray tube**



A table is displayed with a list of exposures.

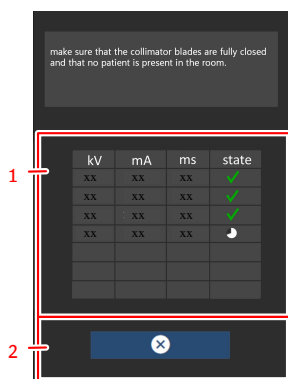

1. Table with list of exposures
2. Button to cancel the warming-up procedure

**Figure 42: List of exposures for warming-up of the X-ray tube**

5. Make sure that the collimator blades are fully closed and that no patient is present in the room.  
To avoid radiation on a DR detector, remove the detector, turn the tube away from the detector, or cover the detector with a lead apron.
6. Perform the exposures and wait for the timer icon to finish between exposures.  
The exposure parameters are set automatically.

## Performing an exposure using the DR Detector

---

- [Step 1: retrieve the patient info](#) on page 74
- [Step 2: select the exposure](#) on page 75
- [Step 3: Prepare the exposure](#) on page 76
- [Step 4: Check the exposure settings](#) on page 77
- [Step 5: execute the exposure](#) on page 78
- [Step 6: perform a quality control](#) on page 78

## **Step 1: retrieve the patient info**

At the MUSICA Acquisition Workstation:

1. When a new patient comes in, define the patient info for the exam.
2. Start the exam.

If the workstation is connected to a second monitor that is positioned outside the operator room, make sure that the patient data is not exposed to unauthorized persons.

## Step 2: select the exposure

In the operator room:

At the NX workstation, select the thumbnail for the exposure in the **Image Overview** pane of the **Examination** window.

The default X-Ray exposure parameters for the selected exposure are sent to the modality and displayed on the software console.

The selected DR Detector is activated.

The DR Detector Switch shows which DR detector is active and shows its status.

- Flashing: starting up
- Green (constant): ready for exposure

### Step 3: Prepare the exposure

1. In the examination room, position the X-Ray system:  
To position the X-Ray system manually, use the control buttons on the control panel.
2. Position the DR Detector either in the DR bucky or on the radiographic table. The DR Detector Switch shows which DR Detector is active and shows its status.  
When using the bucky, check that the identification labels on the DR Detector and on the bucky match. Do not use a DR Detector that is dedicated to another bucky.
3. Position the patient:
  - a) Position the patient.
  - b) Check if the X-Ray system position is suitable for the exposure.
  - c) Make final adjustments to the position of the X-Ray system using the control buttons on the control panel.
  - d) Switch on the light localizer on the collimator. Adapt collimation if required.
  - e) Apply radiation protective measures for the patient if needed.



**Warning:** Monitor the patient position (hands, feet, fingers, etc.) with special care to avoid injury to the patient caused by unit movements. Patient hands must be kept away from mobile components of the unit. Intravenous tubing, catheters and other patient connected lines should be routed away from moving equipment.



**Warning:** Avoid unnecessary dose by always checking the exposed area using the collimator light, by limiting the exposed area using the collimator and lead shielding and by wearing radiation protection garments.



**Warning:** An inappropriate selection of AEC cells can lead to additional dose to the patient or a retake.



**Warning:** Liquids ingressing the DR Detector may cause malfunction and contamination.



If there is a chance that the detector comes in contact with liquids (bodily fluids, disinfectants, ...), the DR Detector must be wrapped in a protective plastic bag while performing the examination.

#### Related information

[Positioning the X-Ray Tube](#) on page 108

## Step 4: Check the exposure settings

### Related information

[Generator controls](#) on page 93

On the NX application:

1. Check if the DR Detector Switch displays the name of the DR Detector that's being used
2. If a wrong DR Detector is displayed, select the right DR Detector by clicking the drop down arrow on the DR Detector Switch.
3. Check if the status of the DR Detector is ready for exposure.

On a DR Detector that has a status indicator:

Check if the status of the DR Detector is ready for exposure. If the status is not ready for exposure, the DR Detector cannot be used for making an exposure.

In the operator room at the X-ray generator console:

1. Check if the exposure settings displayed on the console are suitable for the exposure.
2. If other exposure values are required than those defined in the NX exam, use the console to overwrite the default defined exposure settings.

## Step 5: execute the exposure

In the operator room:

Press the exposure button to execute the exposure.



Make sure the generator is ready for exposure before you press the exposure button.



**Warning:** During exposure ionizing radiation is emitted by the X-ray system. To indicate the presence of ionizing radiation, the radiation indicator on the control console lights up.



**Warning:** Do not select another thumbnail until the preview image is visible in the active thumbnail.

In the operator room at the NX workstation:

- The image is acquired from the DR detector and displayed in the thumbnail.
- The actual X-Ray exposure parameters are sent back from the generator to the NX workstation and are shown in the Image Detail pane.
- If collimation is applied, the image is automatically cropped at the collimation borders.

## Step 6: perform a quality control

At the MUSICA Acquisition Workstation:

1. Select the image on which quality control is to be performed.
2. Prepare the image for diagnosis by using e.g. L/R markers or annotations.
3. If the image is OK, send the image to a hardcopy printer and/or PACS (Picture Archiving and Communication System).

## Performing an exposure using a CR cassette

---



**Note** Using an ID Tablet to identify cassettes before the exposure will break the communication of X-ray parameters between the NX workstation and the X-ray generator console. It is advised to identify cassettes after the exposure, as described in this workflow.

- [Step 1: retrieve the patient info](#) on page 74
- [Step 2: select the exposure](#) on page 81
- [Step 3: prepare the exposure](#) on page 82
- [Step 4: check the exposure settings](#) on page 82
- [Step 5: execute the exposure](#) on page 83
- [Step 6: repeat steps 2 to 5 for the next subexposures](#) on page 83
- [Step 7: digitize the image](#) on page 83
- [Step 8: perform a quality control](#) on page 83

## **Step 1: retrieve the patient info**

At the MUSICA Acquisition Workstation:

1. When a new patient comes in, define the patient info for the exam.
2. Start the exam.

If the workstation is connected to a second monitor that is positioned outside the operator room, make sure that the patient data is not exposed to unauthorized persons.

## Step 2: select the exposure

In the operator room at the NX workstation:

1. Select the thumbnail for the exposure in the Image Overview pane of the Examination window.
2. Select CR in the Detector Switch.
3. Select the Modality Position (radiographic table, radiographic wall stand, free exposure) in the Software Console.

The default X-Ray exposure parameters for the selected exposure are sent to the modality and displayed on the software console.

The radiographic table or radiographic wall stand lights up in blue, indicating the selected modality position.

4. Select the subexposure if more than one image is required for the same cassette.  
If an image thumbnail is configured for multiple exposures on a single cassette, another set of thumbnails is shown in the image detail pane. Now you have to select one of these thumbnails to send the proper default X-Ray exposure parameters to the modality for each exposure.



**Note** When working in a PACS environment, the preferred workflow is to have only one image per cassette. This is needed for optimal use of hanging protocols. However, in particular cases (e.g. printing sites) it is supported to make more than one exposure per cassette.

### Step 3: prepare the exposure

In the examination room:

1. Position the cassette.



**Note** For a free exposure, partial lead covering of the cassette may be required if multiple images are taken on one cassette.



**Note** For a bucky exposure, always insert an unexposed cassette in the bucky.

2. Position the patient.

Apply radiation protective measures for the patient if needed.

3. Check if the X-Ray system position is suitable for the exposure.
4. Position the X-Ray tube with respect to the cassette and the patient.
5. Set the correct distance between cassette and X-Ray tube.
6. Switch on the light on the collimator. Adapt collimation if required.

Take care that the collimated area is not larger than the cassette.



**Warning:** Monitor the patient position (hands, feet, fingers, etc.) with special care to avoid injury to the patient caused by unit movements. Patient hands must be kept away from mobile components of the unit. Intravenous tubing, catheters and other patient connected lines should be routed away from moving equipment.

### Step 4: check the exposure settings

In the operator room on the Software Console:

1. Check if the exposure settings displayed on the console are suitable for the exposure.
2. Check the Ready for Exposure status.

## Step 5: execute the exposure

In the operator room:

Press the exposure button to execute the exposure.



**Warning:** During exposure ionizing radiation is emitted by the X-ray system. To indicate the presence of ionizing radiation, the radiation indicator on the control console lights up.

- The actual X-Ray exposure parameters are sent back from the generator to the NX workstation and are shown in the Image Detail pane.
- The actual X-Ray exposure parameters and the Exposure Index (EI) value on the NX workstation can be used to monitor the performance of the Automatic Exposure Control of the X-Ray system.
- A green OK mark appears on all thumbnails for which the exposures are made and for which exposure settings are sent back to the NX workstation.

## Step 6: repeat steps 2 to 5 for the next subexposures

## Step 7: digitize the image

In the examination room:

Take the exposed cassette.

In the operator room:

1. Insert the cassette in the digitizer.
2. Click ID in the examination window of NX.



**Note** You can also use an ID Tablet to identify the cassette and digitize it using any digitizer.

The image will appear in the image overview pane of the examination window.

## Step 8: perform a quality control

In the operator room at the NX workstation:

1. Select the image on which quality control is to be performed.
2. Prepare the image for diagnosis by using e.g. L/R markers or annotations.
3. If the image is OK, send the image to a hardcopy printer and/or PACS (Picture Archiving and Communication System).

## Stopping the System

---

To stop the system:

1. Stop the MUSICA Acquisition workstation.

The MUSICA Acquisition workstation can be stopped in two ways, either by logging out of Windows or without logging out of Windows.

For detailed information, refer to the MUSICA Acquisition workstation User Manual, document 4420.

2. Press the Power OFF button on the X-ray generator mini console to switch off the generator.
3. Power off the DR detector:

- turn off the DR detector.
- remove the battery pack.



**Note** If the DR detector is powered down, a warming-up may be required on the next start-up.





**Warning:** If the system has just been stopped, wait at least 10 seconds before starting it again.

## Software Console

---

The software console is displayed on the NX workstation.

**Table 9: Navigation**

Navigation button	Software console screen
	Generator controls
	X-ray modality controls
	System messages

- [X-ray modality status frame](#) on page 85
- [Generator controls](#) on page 93
- [X-ray modality controls](#) on page 103
- [System messages screen](#) on page 104

## X-ray modality status frame

---

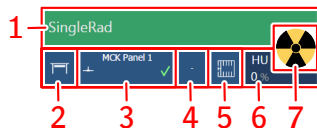



1. Ready for exposure status
2. Modality position
3. DR detector switch
4. Filter status
5. Grid status
6. Heat units
7. Radiation status

**Figure 43: X-ray modality status frame**

- [Ready for exposure status](#) on page 86
- [Modality Position](#) on page 87
- [DR Detector Switch](#) on page 88
- [Filter Status](#) on page 89
- [Anti-scatter grid status](#) on page 90
- [Radiation status](#) on page 91
- [Unknown status](#) on page 92

## Ready for exposure status

Table 10: Exposure ready





Color	Description
	Green Exposure ready. Indicates that the selected technique is properly set and there are no interlock failures or system faults.
	Red Exposure not ready. Check the message frame for more information. It is not possible to perform an exposure due to an error. The status will turn to green when problem is solved.
	Blue Exposure not ready. No examination defined.

## Modality Position

The modality position is automatically selected, based on the selected exposure.

To modify the position on the modality where the exposure will be made, click the drop-down arrow and select the modality position from the list.

**Table 11: Modality Position**

Icon	Description
	The image is planned for the radiographic table.
	The image is planned for the radiographic wall stand.
	The image is planned as a free exposure.
	A manual X-ray exposure can be made. No image will be acquired on the NX workstation.

The type and configuration of the X-ray system defines which modality positions are available.

The available workstations depend on the modality type and configuration.

## DR Detector Switch

The DR Detector Switch shows which DR Detector is active and shows its status. The DR Detector Switch can be used to activate another DR Detector. The DR Detector Switch can be switched to CR, depending on the configuration.



Figure 44: DR Detector Switch

### Related information

[X-ray modality status frame](#) on page 85

### DR detector status

Table 12: Status of the battery





Battery status icon					
Meaning	Full	Medium	Low	Empty	Charging

Table 13: Status of the network connection









Connection status icon (wifi/wired)				
Meaning	Strong	Normal	Weak	Wired DR Detector

Table 14: Status of the DR detector

DR detector status icon					
Meaning	Ready	Initializing exposure	Error	Sleep	One DR detector must be selected

## Filter Status

Based on the selected exposure, the filter status indicates if a filter is required.

**Table 15: Manual filter**

(no icon)	Empty: no filter is required.
	Orange: a filter is required. Insert the filter manually.

## Anti-scatter grid status

**Table 16: Grid status**

(no icon)	No grid is required.
	A grid is required.



### Related information

[Status information on the tube head display](#) on page 106

[Anti-scatter grids](#) on page 129

## Radiation status

**Table 17: Radiation status**

	The X-ray tube is prepared.
	After pressing the exposure button completely, the X-ray exposure is made. The indicator on the console will light up.
	The examination room door is open.

Press the exposure button halfway (“Prep” position) to prepare the X-ray tube for exposure. The indicator will light up when the X-ray tube is prepared and there are no interlock failures or system faults.

After pressing this push-button, the following functions are activated:

- Anode rotation.
- Filament current switches from stand-by to the selected mA.

## Unknown status

If a status is unknown, a question mark icon is displayed:



### Figure 45: Unknown status

Depending on the component for which the unknown status is displayed, an action is required on the component or on the software to provide the system with the missing information.

E.g. to solve the unknown detector status, one DR detector must be selected.

## Generator controls

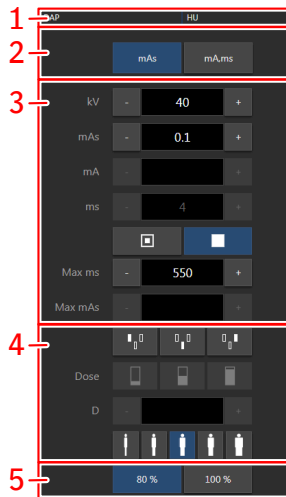

1. Heat units and DAP value
2. Radiographic working mode
3. Radiographic parameters
4. Automatic exposure control
5. X-ray tube load

**Figure 46: Operation controls**

To change a value, use the + and - buttons. The values increase or decrease step by step each time the corresponding button is pushed. To change a value without repeatedly pushing the buttons, push the value twice. The buttons change into **fast-forward** and **fast-backward** buttons. Push and hold the button to change the value.



After exposure all values reflect the settings actually used by the generator.

- [One point, two point and three point working modes](#) on page 94
- [Radiographic Parameters](#) on page 95
- [Focal Spot Indicator](#) on page 96
- [Automatic Exposure Control \(AEC\)](#) on page 97
- [X-ray tube load](#) on page 100
- [DAP Value](#) on page 101
- [Heat Units](#) on page 102

## One point, two point and three point working modes

You can select following radiographic working modes according to the parameters to be controlled and the degree of automation:

**Table 18: Radiographic working modes**

	One point mode, by selecting kV. The exposure is controlled by AEC.
	Two point mode, by selecting kV and mAs. AEC is disabled.
	Three point mode, by selecting kV, mA and exposure time independently. AEC is disabled.

To switch to one point mode, activate one or more AEC fields.

Depending on the radiographic working mode, some of the generator controls will be disabled.

### One Point Mode (1P)

By selecting one of the AEC field buttons, the one point mode is activated.

The value of kV, mA, max ms, max mAs, the setting of focal spot, density, dose, patient size and the selected AEC fields can be adjusted.

The value for mAs and ms is not available.

For accurate AEC operation it may be needed to lower the mA value in order to obtain longer exposure times. The smallest exposure step is 1 ms.

Disabling all AEC fields will switch to two point mode.

After exposure all values reflect the settings actually used by the generator.

### Two Point Mode (2P)

The value of kV, mAs, max ms, the setting of focal spot and X-ray tube load can be adjusted.

The value of mA and ms are adjusted automatically to keep the mAs value constant, within the boundaries of generator or X-ray tube limitations.

The setting of density, dose and patient size is not available.

By selecting one of the AEC field buttons, the one point mode is activated.

By adjusting the value of mA or ms, the three point mode is activated.

After exposure all values reflect the settings actually used by the generator.

### Three Point Mode (3P)

The value of kV, mA and ms can be adjusted. The other values are adjusted automatically to keep the mAs value constant.

## Radiographic Parameters

You can set up following radiographic parameters:



- **kV**: shows the radiographic kV value (X-ray tube voltage) selected for the exposure.
- **mAs** can show:
  - The radiographic mAs value selected for the exposure.
  - When an exposure is made, it shows the actual mAs at the end of the exposure.
- **mA** can show:
  - The radiographic mA value (electrical current) selected for the exposure.
  - When an exposure is made, it shows the the actual mA at the end of the exposure
- **ms** can show:
  - The time value (in milliseconds) selected for the exposure.
  - When an exposure is made, it shows the actual time at the end of the exposure.
- **Max ms** shows the integration time of the DR detector. When operating the DR detector, the calculated exposure time (ms) or manual overrides can never exceed the integration time (detector ms) of the DR detector.
- **Max mAs** shows the maximum allowed mAs value for exposures using AEC. The highest allowed setting for max mAs depends on the mA setting and the detector ms setting. Not available in Free Exposure mode using DR or Free Exposure mode using CR.

When using AEC, the exposure is terminated by the detector ms or max mAs settings, even if the target dose is not reached.

## Focal Spot Indicator

A focal spot indicator shows the selected focal spot of the X-ray tube: “Small” or “Large”.

**Table 19: Focal Spot Indicator**

	Small
	Large

If you change the focal spot, the kV and mAs are kept constant. When changing from a large to smaller focal spot, exposure time may increase as the mAs is kept constant but the mA may be reduced automatically according to the performance of the tube.

## Automatic Exposure Control (AEC)

Automatic Exposure Control (AEC) produces consistent detector dose regardless of the radiographic technique selected and of the patient size.

To activate AEC mode, push any of the three AEC field buttons.



**Figure 47: AEC field buttons**

To deactivate AEC mode, select the two point or three point radiographic working mode.



**Figure 48: Buttons to select two point or three point radiographic working mode**

### AEC field selection

Each button indicates its related physical location of the selected field in the AEC exposure detector, and you may select or deselect it by touching it.

Any combination of fields can be selected and the color of the buttons changes (highlighted) when active. The exposure is ended if any of the selected fields measures the AEC cut-off dose.

**Table 20: AEC field selection**

	Left field
	Middle field
	Right field

### Dose

Each of these buttons allows adjustment of the AEC cut-off dose (low dose, middle dose and high dose), depending on configuration at installation time and on the selected patient age group. Each time a button is selected (highlighted), the others are automatically deselected.

**Table 21: Automatic filter**

Dose	
	low dose
	middle dose

<b>Dose</b>	
	high dose

### Density

These buttons are used to adjust the AEC cut-off dose (and patient entrance dose accordingly).

Density can be increased and decreased in a range of -4 to +4. Each step is a change of one exposure step. An exposure step is a change of approximately -20% or +25% in dose. When disabled, the density range number appears in black.

**Table 22: Dose variation compared to reference dose**

Density	Dose
-4	0.41
-3	0.51
-2	0.64
-1	0.80
0	1 (reference dose)
+1	1.25
+2	1.56
+3	1.95
+4	2.44

### Patient Size

The size of the patient is classified in five categories: Extra Small, Small, Medium, Large and Extra Large.

Press one of the buttons to select the desired patient size.





In one point mode, the patient size affects the values of kV and density.

In two point mode, the patient size affects the values of kV and mAs.





The default values for adjusting kV and mAs are listed in the following tables.

Depending on the configuration, the default behaviour can be overruled and the parameters that are affected by the patient size and the actual variation values can be defined specifically for each exam type.

**Table 23: kV variation over patient size**

	Patient size	kV
	Extra Small	normal kV * 0.9
	Small	normal kV * 0.95
	Medium	normal kV
	Large	normal kV * 1.05
	Extra Large	normal kV * 1.1

**Table 24: mAs variation over patient size**

	Patient size	mAs
	Extra Small	normal mAs * 0.25
	Small	normal mAs * 0.5
	Medium	normal mAs
	Large	normal mAs * 2
	Extra Large	normal mAs * 4

**AEC dose failure**

In AEC mode the exposure is interrupted automatically, when there is not enough dose detected within a certain time (e.g. when the AEC chamber is defect or covered with lead foil) or when there is too much dose detected within a certain time (e.g. when no patient is in front of the AEC).

## X-ray tube load

**Table 25: X-ray tube load**

80%	As a way to increase the tube life cycle, the power percentage of the tube is reduced to a 80% by default.
100%	If a specific technique requires 100% of the X-ray tube power, touch the 100% button.

Depending on the status of the heat units, the system may limit the X-ray tube load, even when the X-ray tube load is set to 100%.

## DAP Value

The DAP value shows the radiation value of the last exposure. The radiation measure is read as DAP value (Dose Area Product) in  $\text{cGy} \cdot \text{cm}^2$  (for example: DAP 12.22). This measurement unit is configurable.

A new exposure resets the DAP value.

## Heat Units

The status of the heat units is displayed below the X-ray icon.

During exposures, the heat units are calculated and totalled. The heat units display shows the percentage of the thermal capacity of the X-ray tube that is used. For example, a display of "HU 0" (0%) would indicate that all the heat units capacity of the X-ray tube remains. A display of "HU 100" (100%) would indicate that maximum heat capacity of the X-ray tube is reached and no exposures can be made until the tube has cooled down.

## X-ray modality controls

---

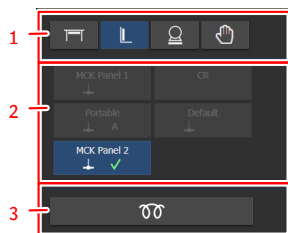

1. Select the modality position.
2. Select the DR detector.

All configured detectors are displayed. Only the detectors that can be used with the selected modality position, can be selected.

3. Automated workflow for warming-up of the X-ray tube

**Figure 49: X-ray modality controls**

## System messages screen

System messages are displayed at the bottom of the software console.

The color of the message indicates the importance:

Blue	Information
Yellow	Warning
Orange	Error

Messages that require feedback from the user contain a button that can be pressed.

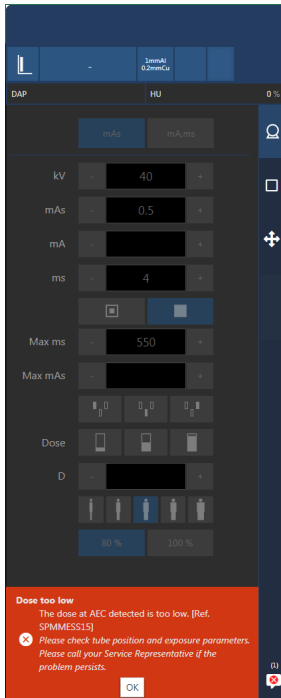

**Figure 50: Error message requiring user feedback**

More than one message can be active. The number of active messages and the type of messages is indicated on the navigation button.



**Figure 51: Icon indicating that messages are waiting**

The system messages screen lists all messages since the last startup of the software.

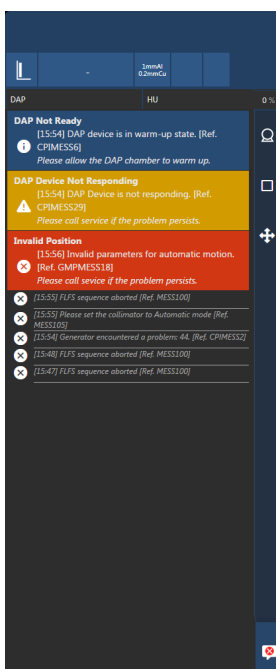

**Figure 52: Messages history**

#### Related information

[X-ray generator messages and warning signals \(Spellman\)](#) on page 136

[Warning messages](#) on page 141

## Tube head display

The tube head display shows the positioning parameters and status information.

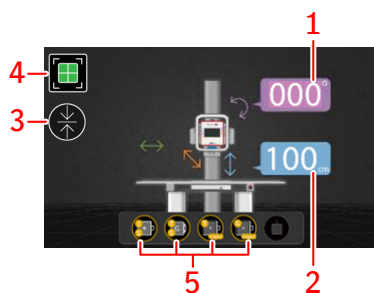

1. Readout value of X-ray tube angle (alpha)
2. Readout value of source image distance (SID)
3. Icon displayed if automatic centering and position tracking is active
4. Alignment of X-ray tube and DR detector bucky
5. Bucky status



**Figure 53: Positioning parameters for table exposures**

While pressing and holding a positioning button, a corresponding icon is displayed on the tube head display.

- [Status information on the tube head display](#) on page 106

## Status information on the tube head display

Table 26: X-ray tube centering

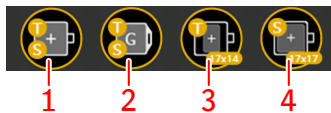

	The X-ray tube and the DR detector are aligned.
	The X-ray tube and the DR detector are not aligned. It is not possible to perform an exposure.
	The bucky is open or empty. It is not possible to perform an exposure.



1. Bucky tray of radiographic table and wall stand
2. Grid of radiographic table and wall stand
3. Size and orientation of the DR detector in the radiographic table
4. Size and orientation of the DR detector in the radiographic wall stand





Figure 54: Bucky status

Table 27: Status of the bucky tray of the radiographic table and wall stand



	The bucky trays are both closed.
	The bucky tray of the radiographic table is open.
	The bucky tray of the radiographic wall stand is open.

	The bucky trays are both open.
---	--------------------------------

**Table 28: Status of the anti-scatter grid of the radiographic table and wall stand**





	The grids are both inserted properly.
	The grid of the radiographic table is removed or inserted wrongly. The grid of the radiographic wall stand is inserted.
	The grid of the radiographic wall stand is removed or inserted wrongly. The grid of the radiographic table is inserted.
	The grids are both removed or inserted wrongly.

**Table 29: Size and orientation of the DR detector in the radiographic table**

	The bucky contains a DR detector with a size of 14x17 inch (35x43 cm) in landscape orientation.
	The bucky contains a DR detector with a size of 14x17 inch (35x43 cm) in portrait orientation.
	The bucky contains a DR detector with a size of 17x17 inch (43x43 cm)

	The bucky is empty.
---	---------------------

**Table 30: Size and orientation of the DR detector in the radiographic wall stand**

	The bucky contains a DR detector with a size of 14x17 inch (35x43 cm) in landscape orientation and positioned in the center.
	The bucky contains a DR detector with a size of 14x17 inch (35x43 cm) in landscape orientation and aligned to the upper edge of the bucky.
	The bucky contains a DR detector with a size of 14x17 inch (35x43 cm) in portrait orientation and positioned in the center.
	The bucky contains a DR detector with a size of 17x17 inch (43x43 cm)
	The bucky is empty.

## Positioning the X-Ray Tube

The operation controls of the X-ray tube head unit are located at the control panel. The X-ray tube can be positioned by the operator manually.

To release the brake for the selected movement direction or rotation, press and hold the button and move the X-ray tube head unit.

To stop the movement and activate the brake, release the button.



**Note** If movement in any direction blocks, do not apply force to overcome the blocking. Contact your local service organization.



**Note** To avoid shock and damage, move the tube head unit with normal speed and slow down when reaching the mechanical end stops.



**Note** Rotation may be limited by cables. Avoid strain on the cables during rotation.

- [Stop positions](#) on page 110
- [Centering the tube head on the table](#) on page 111
- [Centering the tube head on the wall stand](#) on page 113

**Related information**

[X-ray tube head unit](#) on page 18

## Stop positions

---

The system includes stop positions for manual movement of the X-ray tube head.

The preferred positions of the stops are defined during installation.

The stop positions are used to position the system manually for typical radiographic examinations, e.g. a SID of 180 cm for chest examinations.

Stop positions are different for radiographic table and radiographic wall stand. Which stop positions are active depends on the orientation of the X-ray tube.

To enter a stop position, move the X-ray tube head unit using the control buttons. The movement is stopped when a stop position is reached. Move at a regular speed to prevent the X-ray tube head unit to skip the stop position.

To leave a stop position, release and press again the according movement control button.

## Centering the tube head on the table

---

To move the X-ray tube head to the center of the DR detector in the bucky of the radiographic table and to keep the bucky centered while moving the tube head left and right:

1. On the X-ray tube head, while pressing the transversal movement button, move the X-ray tube towards the center of the radiographic table in transversal direction.



**Figure 55: Transversal movement button**

There is a stop position for centering on the radiographic table.

2. While pressing the longitudinal movement button, move the X-ray tube to the required position.



**Figure 56: Longitudinal movement button**

3. If the exposure is oblique, press and hold the tilting button, to adjust the position of the X-ray tube.



**Figure 57: Tilting button**

4. Press the automatic centering and position tracking button.



**Figure 58: Position tracking button**

The position tracking icon is displayed.



**Figure 59: Position tracking icon**

The bucky is moved automatically to align it to the X-ray tube.

If the X-ray tube is aimed at a position outside of the travel range of the bucky, an error is displayed and the position of the X-ray tube must be adjusted.

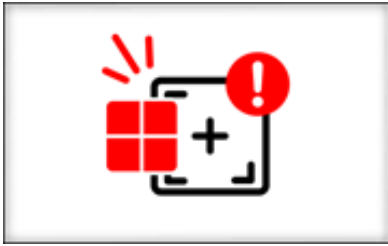

**Figure 60: X-ray tube is aiming at a position outside of the travel range of the bucky**

5. Adjust the position of the X-ray tube head.  
The DR bucky is moving left or right accordingly.

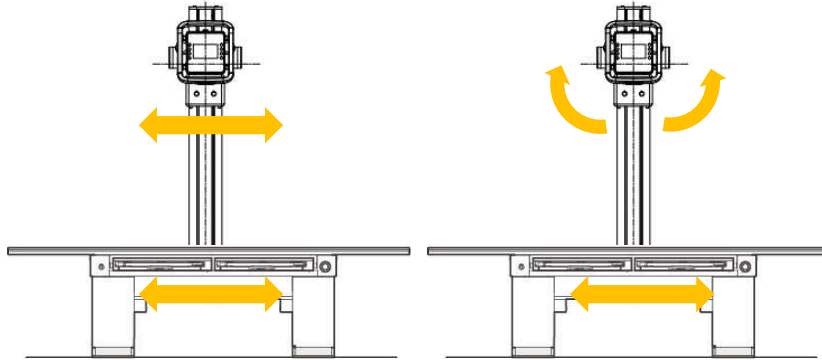

**Figure 61: DR bucky in the table tracks the X-ray tube head**

6. Disable tracking by pressing the position tracking button again.

**Related information**

[X-ray tube head unit](#) on page 18

## Centering the tube head on the wall stand

---

To move the X-ray tube head to the center of the DR detector in the bucky of the radiographic wall stand:

1. On the X-ray tube head, while pressing the transversal movement button, move the X-ray tube towards the radiographic wall stand.



**Figure 62: Transversal movement button**

There is a stop position for centering on the radiographic wall stand.

2. While pressing the tilting button, tilt the X-ray tube 90° towards the radiographic wall stand.



**Figure 63: Tilting button**

3. While pressing the longitudinal movement button, move the X-ray tube to the required SID.



**Figure 64: Longitudinal movement button**

There is a stop position for the default SID.

4. Press the automatic centering and position tracking button.



**Figure 65: Position tracking button**

The position tracking icon is displayed.



**Figure 66: Position tracking icon**

A stop position is enabled, corresponding to the center of the radiographic wall stand.

5. Adjust the X-ray tube head height.



**Figure 67: Vertical movement button**

The movement is stopped when the X-ray tube reaches the center of the radiographic wall stand.

6. Disable the stop position by pressing the position tracking button again.

**Related information**

[X-ray tube head unit](#) on page 18

## Positioning the Radiographic Table

---

The movements of the radiographic table are controlled by foot pedals.



**DANGER:** Make sure that no persons or objects are within the movement area of the system where they can collide with moving parts of the system.



**Warning:** Maintain visual contact with the patient while moving the equipment close to the patient in order to detect hazardous situations (e.g. collisions) early and to avoid them.



**Caution:** Never place any object in front of the foot pedal. Never press a foot pedal by mistake. If an object is placed on a foot pedal or a foot pedal is pressed by mistake, the tabletop may be suddenly moved up or down or horizontally.



**Caution:** Do not put any object such as a chair or drip stand under the tabletop of the radiographic table for any purpose other than examination. Doing so may cause damage to the equipment and the object, or cause the object to fall if the object is pinched by the tabletop.



**Caution:** Be careful for a patient to put neither a hand nor a finger into the clearance between tabletop and Bucky device.



**Caution:** While operating the tabletop, pay attention that your finger or hands are not caught by the clearance between the tabletop and the Bucky device.

- [Positioning the floating tabletop](#) on page 115
- [Adjusting height](#) on page 116
- [Positioning the bucky](#) on page 117

**Related information**

[Emergency stop button](#) on page 27

[Radiographic Table Technical Data](#) on page 159

## Positioning the floating tabletop

To release the brake for moving the floating tabletop, press and hold the middle foot pedal. The tabletop can be moved in longitudinal and transversal direction manually.

At the center position, movement is stopped. Press and hold the middle foot pedal again to release the brake and continue moving the floating tabletop.

To stop movement and activate the brake, release the foot pedal.

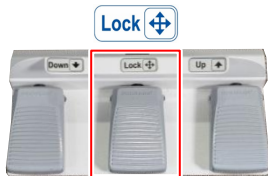

**Figure 68: Foot pedal to release the brake for the floating table top**

Have the patient get on or off the table in the center of the table. If the table top is extended to the maximum length at the head or foot end, the patient must not sit on the end of the table top, since the weight load can lead to table deformations and damage to the product.



**Figure 69: Getting on and off the radiographic table**

In case of very heavy patients the table top has to be positioned in center before the patient getting on. The table top must remain in center also during examination.



The radiographic table is designed for a maximum patient weight of 320 kg. Don't apply a load of more than 100 kg at the end of the table top.

## Adjusting height

---

To adjust the height, click and hold the foot pedal.

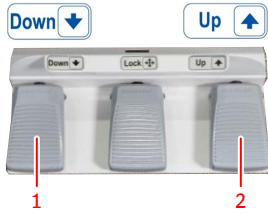

1. Foot pedal to lower table height
2. Foot pedal to raise table height

**Figure 70: Foot pedals to adjust the height of the table**

When minimum or maximum position of the table is reached, the movement is stopped automatically.

## Positioning the bucky

---

1. Use the handle to move the bucky freely in longitudinal direction.
2. To make sure that the X-ray tube head and the bucky are aligned, use automatic centering or check the centering icon on the tube head display.



**Figure 71: Centering icon**

If automatic centering and position tracking is active, the handle cannot be used to move the bucky. Reposition the X-ray tube head to move the bucky.

## Radiographic Table Accessories

---



**Warning:** Using wrong accessories that cannot be properly attached to the system can lead to hazardous situations and injury. Use only original accessories provided by the manufacturer.

- [Mounting the patient hand grips](#) on page 118
- [Lateral cassette holder](#) on page 119
- [Mounting the compression belt](#) on page 120
- [Mattress](#) on page 121

## Mounting the patient hand grips

---

The pair of patient hand grips are used to stabilize the patient and give a feeling of security. Using the hand grips will avoid the patient grasping the table edges which could cause a risk to pinch fingers.

To mount a hand grip:

1. Slide the hand grip in the rails of the tabletop.
2. Tighten the hand screw to lock the hand grip in position.

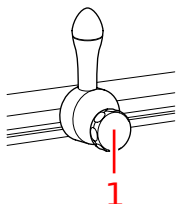

1. Hand screw

**Figure 72: Hand grip**



**Note** The hand grips are not intended to support the weight of the patient.

## Lateral cassette holder

The lateral cassette holder supports a cassette or detector in lateral position and is attached to the tabletop.

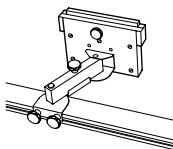
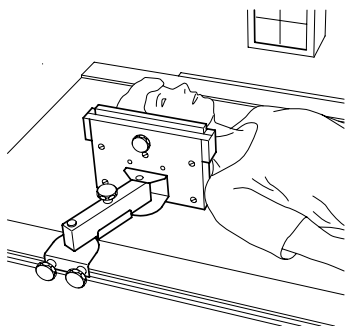

**Figure 73: Lateral cassette holder**

- [Lateral Exposures](#) on page 119

## Lateral Exposures

1. Position the X-Ray tube head unit for lateral exposure over the table.  
If an automatic position is configured for lateral exposures, the X-Ray tube can be positioned using the automatic positioning.
2. Mount the lateral cassette holder on the side rail of the tabletop. Fix it using the two lower screws. Take care to lift the holders slightly up when moving it, to protect the tabletop from scratching.
3. Insert a cassette or a DR detector. Fix it using the upper screw.
4. Position the patient on the table between the X-ray tube and the lateral cassette holder. Adjust the lateral cassette holder to position the cassette as close as possible to the patient. Fix the position using the middle screw.



**Figure 74: Lateral Exposures**

## Mounting the compression belt

---

The compression belt provides additional fixation for the patient on the table. It can be adjusted to patient thickness.

1. Slide both ends of the compression belt in the rails of the tabletop and wrap the compression belt around the patient.

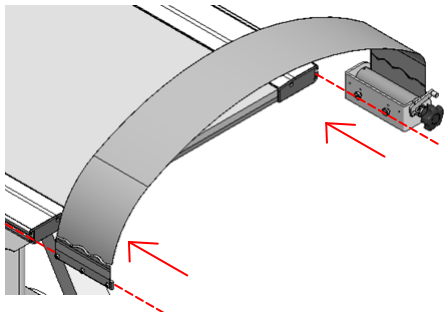

**Figure 75: Rails at the side of the tabletop**

2. Tighten the hand screw to apply compression force to the patient.

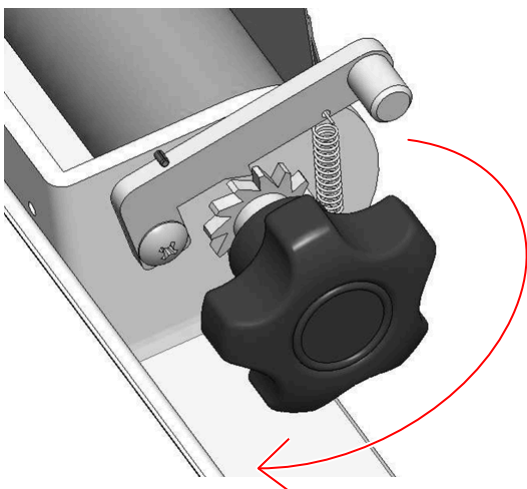

**Figure 76: Hand screw for tightening the compression belt**

3. Pull the release lever and turn the hand screw counterclockwise to release the pressure.

## Mattress

---

The mattress fits the tabletop (220 cm x 80 cm) and is X-ray translucent.

## Positioning the Radiographic Wall Stand

---



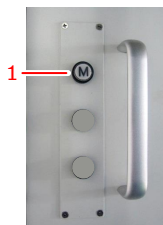

To adjust the height manually, release the brake for vertical movement by pressing and holding the button at the side panel of the bucky. The bucky can be moved up and down using the handgrip.

To stop movement and lock the bucky into position, release the button.



1. Button to release the brake for the manual movement

**Figure 77: Positioning controls**

-  **DANGER:** Make sure that no persons or objects are within the movement area of the system where they can collide with moving parts of the system.
-  **Warning:** Maintain visual contact with the patient while moving the equipment close to the patient in order to detect hazardous situations (e.g. collisions) early and to avoid them.
-  **Warning:** Be careful not to squeeze your finger or hand. Keep your hands at the handles while positioning the system.
-  **Caution:** The maximum load for the wall stand movement in vertical direction is 20 kg. The bucky unit may slip downwards when applying excessive load.
-  **Note** Do not move the bucky with excessive force to the end stop positions.

### Related information

[Emergency stop button](#) on page 27

[Wall stand technical data](#) on page 160

## Radiographic Wall Stand Accessories

---

-  **Warning:** Using wrong accessories that cannot be properly attached to the system can lead to hazardous situations and injury. Use only original accessories provided by the manufacturer.

- [Patient hand grips](#) on page 122
- [Mounting the lateral arm rest](#) on page 123

## **Patient hand grips**

---

The patient hand grips for wall stand are mounted fixed at the backside of the bucky. The patient uses these grips for stabilization and support of correct positioning, e.g. for chest exams.

## Mounting the lateral arm rest



**Caution:** The lateral arm rest can bear up to 20 kg. It is not intended to hold the whole weight of a patient.

Take care that the lateral arm rest does not collide with the ceiling when moving the bucky upward.

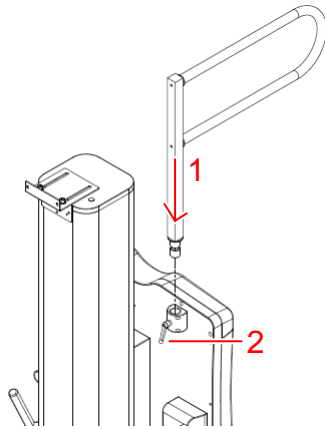

**Figure 78: Knob for locking the lateral arm rest**

To mount and position the lateral arm rest:

1. Insert the lateral arm rest in the mounting slot at the rear side of the bucky frame.
2. Turn the lever clockwise to lock the lateral arm rest.

## Bucky

The bucky is installed in the radiographic table and in the radiographic wall stand.

The bucky clamps the detector during exposure and centers it relative to the Automatic Exposure Control (AEC) and the grid.

The bucky supports DR detectors of 14x17 inch (43x35 cm) and of 17x17 inch (43x43 cm).

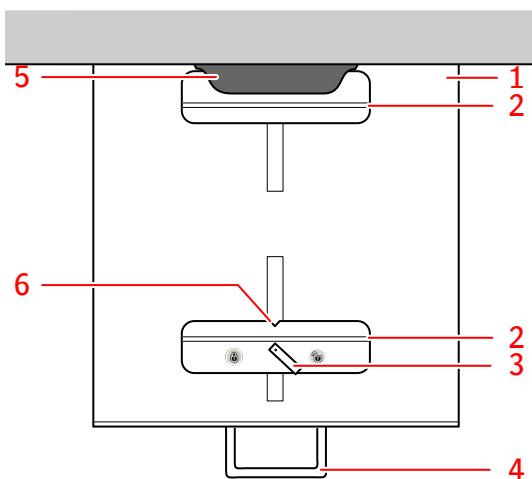

1. Bucky drawer

2. Clamps
3. Lock lever
4. Bucky drawer handle
5. Anti-scatter grid handle
6. Center mark

**Figure 79: Bucky in the radiographic table**

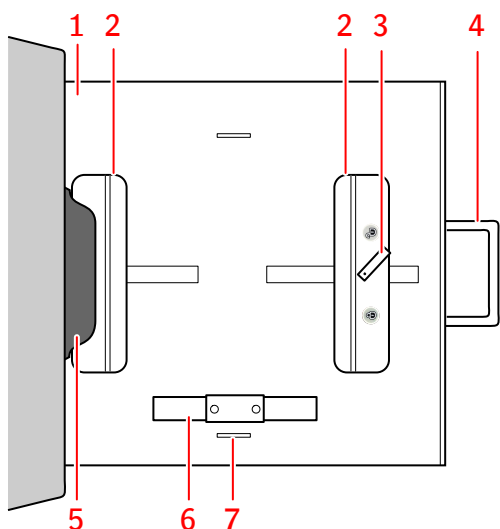

1. Bucky drawer
2. Clamps
3. Lock lever
4. Bucky drawer handle
5. Anti-scatter grid handle
6. Detachable clamp
7. Slit for attaching the detachable clamp

**Figure 80: Bucky in the radiographic wall stand**

When the detachable clamp is not used, it can be stored by attaching it magnetically at the rear side of the wall stand bucky.

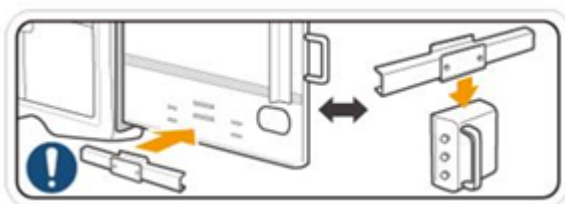
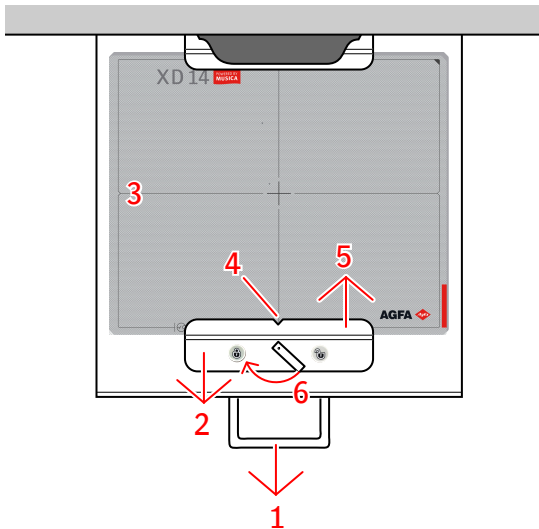

**Figure 81: Storing the detachable clamp**

- [Loading of the bucky in the table](#) on page 125
- [Loading of the bucky in the wall stand](#) on page 126
- [Unloading of the bucky in the table](#) on page 127
- [Unloading of the bucky in the wall stand](#) on page 128
- [Anti-scatter grids](#) on page 129
- [Automatic Exposure Control \(AEC\)](#) on page 133

## Loading of the bucky in the table

To load the bucky with a detector:



**Figure 82: Loading of the bucky in the radiographic table**

1. Open the bucky drawer completely by pulling the front handle.
2. Open the clamps by pulling the front slider.
3. Position the detector between the clamps.



**Caution:** Make sure your fingers are not between the clamping mechanism and the detector. The clamping mechanism may hurt your fingers, therefore take special care.

4. Align the center of the bucky to the center mark on the clamps.
5. Close the clamps to fix the detector position.
6. Lock the clamps by turning the lock lever clockwise.

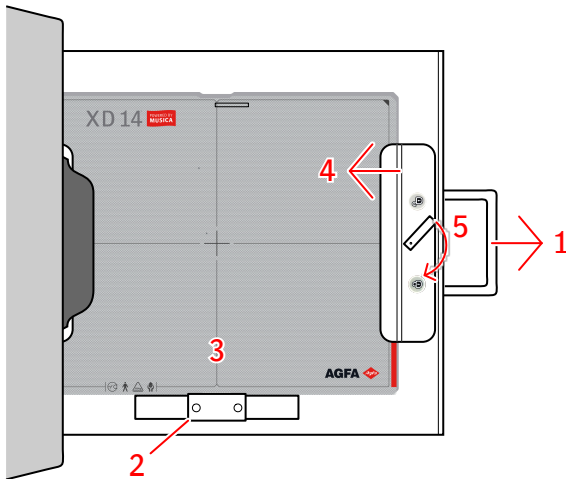

**Figure 83: Lock icon**

7. Close the bucky drawer using the front handle.  
Make sure the bucky drawer is pushed up to the end to close completely.

## Loading of the bucky in the wall stand

To load the bucky with a detector:



**Figure 84: Loading of the bucky in the wall stand**

1. Open the bucky drawer completely by pulling the front handle.
  2. Adjust the detachable clamp by attaching it to the slit that corresponds to the bottom alignment of the detector.
    - Detector height 17 inch (43 cm): no clamp needed
    - Detector height 14 inch (35 cm): use the lower position of the clamp for centering the detector in the bucky, and the higher position of the clamp for aligning the detector to the upper edge of the bucky.
  3. Let the detector rest on the clamp, while keeping it in position with one hand.
  4. Close the clamps to fix the detector position.
- ⚠ Caution:** Make sure your fingers are not between the clamping mechanism and the detector. The clamping mechanism may hurt your fingers, therefore take special care.
5. Lock the clamps by turning the lock lever clockwise.



**Figure 85: Lock icon**

6. Close the bucky drawer using the handle.  
Make sure the bucky drawer is pushed up to the end to close completely.

## Unloading of the bucky in the table

---

To unload the bucky with a detector:

1. Open the bucky drawer completely by pulling the front handle.
2. Unlock the clamps by turning the lock lever counterclockwise.



**Figure 86: Unlock icon**

3. Open the clamps.
4. Lift the detector and remove it from the clamping. The openings in the carrier allow your fingers to grip the detector.
5. Load the bucky with another detector.
  - Alternatively, close the bucky drawer using the front handle and pushing the button to release the brake.

## Unloading of the bucky in the wall stand

---

To unload the bucky with a detector:

1. Open the bucky drawer completely by pulling the handle.
2. Unlock the clamps by turning the lock lever counterclockwise.



**Figure 87: Unlock icon**

3. Open the clamps, while keeping the detector in position with one hand.
4. Remove the detector.
5. Load the bucky with another detector.
  - Alternatively, close the bucky drawer using the handle.

## Anti-scatter grids

---

Anti-scatter grids are used to reduce scattered radiation and improve image quality. Grids are available as an option.

For DR detectors focused grids are used. Focused grids require centering of the X-ray source to the detector and a specific distance range between X-ray source and detector. The color of the handle of the grid indicates which distance the grid is used for.

To change the grid in the radiographic table or the radiographic wall stand:

1. Pull out the grid using the handle.
2. Store the grid in a safe place to avoid damage.
3. Insert the grid with labels facing up in the appropriate slit of the bucky. Make sure the grid is pushed up to the end.



**Warning:** Handle anti-scatter grids with care and store them in a safe place when not in use. Dropping the grid can cause damage and create visible image artifacts or reduce image quality.



**Caution:** Using a focused anti-scatter grid with the X-ray source not centered or on a wrong distance may cause reduced image quality.



**Caution:** Injury of the patient or damage to the equipment can be caused by the anti-scatter grid if it is not properly inserted in the bucky.

- [Anti-scatter grids](#) on page 130
- [Anti-scatter grid focal distance color indication](#) on page 131
- [Storage box for DR detector and anti-scatter grids](#) on page 132

### Related information

[Status information on the tube head display](#) on page 106

[Anti-scatter grid status](#) on page 90

## Anti-scatter grids

Anti-scatter grids are used to reduce scattered radiation and improve image quality. Grids are available as an option.





Refer to the Agfa website for specifications on the anti-scatter grids that have been found compatible with the system and the DR Detectors.

<http://www.agfahealthcare.com/global/en/library/overview.jsp?ID=54332498>

## Anti-scatter grid focal distance color indication

The handle of the grid is visible when the grid is inserted and its color indicates the focal distance of the grid.

**Table 31: Grid focal distance color indication**

Focal Distance	Color	
100 cm	red	
150 cm	green	
180 cm	blue	
Parallell grid	gray	

## Storage box for DR detector and anti-scatter grids

The storage box provides vertical storage space for a DR detector and up to three grids. It can be mounted to the wall or stand on a stable surface.

**!** **Caution:** insert the DR detector and the anti-scatter grids in the storage box with care to avoid damage. Do not drop the items in the storage box.

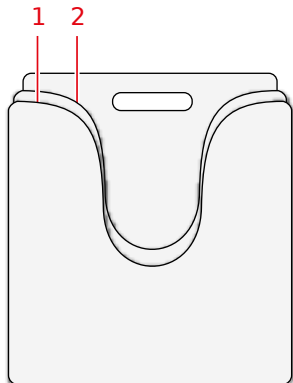

1. Storage space for a DR detector
2. Storage space for up to three grids

**Figure 88: Storage box**

## Automatic Exposure Control (AEC)

---

The use of an AEC ensures optimal and reproducible image quality independent of the radiation, the object exposed or other factors.

The AEC has three cells (ionization chambers).

The AEC is mounted in the bucky of the radiographic table and the radiographic wall stand between the grid and the detector. It is fixed and not intended to be removed from the bucky by the customer. If an exposure shall be done without AEC, the free exposure workflow has to be used, where the detector is placed outside the bucky, or the AEC has to be switched off in the Software Console.

The AEC is calibrated during production with default values. The AEC can be recalibrated during installation, defining three custom cut-off doses for the AEC cells, to suit user preferences or to balance out the three AEC cells.

The default orientation of the AEC cells on the table corresponds to a patient orientation with the head on the left side. The orientation is decided during installation of the system. A label is delivered with the system to indicate the patient orientation on the table.

The shortest irradiation time when using AEC is 2 ms.



**Note** The AEC cell is located in the bucky above the detector and may be slightly visible on the image. This applies most to flat field exposures and less to diagnostic images.

### Related information

[Automatic Exposure Control \(AEC\) Technical Data](#) on page 166

## X-Ray Generator Mini Console

---

The X-ray generator mini console is limited in functionality to power on and power off the generator and to connect the exposure hand switch to trigger the exposure.

The X-ray exposure parameters are controlled on the **Software Console**.

- [Starting and stopping the generator](#) on page 134
- [X-ray tube start-up modes](#) on page 135
- [X-ray generator messages and warning signals \(Spellman\)](#) on page 136

### Related information



[System Documentation](#) on page 153

[X-ray generator messages and warning signals \(Spellman\)](#) on page 136

## Starting and stopping the generator

---

The generator is switched on and off by the power buttons on the X-ray generator mini console.

	Press the Power ON button on the X-ray generator mini console to switch on the generator.
	Press the Power OFF button on the X-ray generator mini console to switch off the generator.

Following warning is printed on the X-ray generator mini console in English:



**Warning:** This x-ray unit may be dangerous to patient and operator unless safe exposure factors, operating instructions and maintenance schedules are observed.



This label is on the X-ray generator mini console. If the system has just been stopped, wait at least 10 seconds before starting it again, to allow all components to properly shut down.

## X-ray tube start-up modes

---

The system can make exposures using two start-up modes, when pressing the exposure button in preparation stage:

- Low speed start-up that boosts the tube anode to ca. 3000 rpm.
- High speed start-up that boosts the tube anode to ca. 9000 rpm.

No more than four high-speed start-ups are allowed per minute. An error is indicated if the number is exceeded.

High speed start-up is available during no more than 30 seconds. After that period the rotation speed will be reduced to low speed.

After the exposure and when the exposure button is released, the tube anode is braked automatically.

When the X-ray tube anode is rotating with high speed the generator must not be turned off. Please wait until the system is on low speed before switching the generator off. The bearings of the X-ray tube can be damaged if the generator is switched off before the anode is braked.

## X-ray generator messages and warning signals (Spellman)

---

### Acoustic signals

The generator indicates particular states with acoustic signals:

- Exposure is terminated: 500 ms tone
- Errors: rapid series of tones

### Visual signals

The generator indicates particular states with visual signals:

- Preparation: flashing of prepare ready indicator (green LED)
- X-ray tube is prepared: prepare ready indicator is continuously lit (green LED)
- Exposure: radiation indicator is continuously lit (red LED)

### Related information

[System messages screen](#) on page 104

## Problem solving

---

- [Restoring connection between generator and NX after generator failure](#) on page 137
- [DR Detector is Exceeding the Maximum Working Temperature](#) on page 138
- [DR detector must be recalibrated](#) on page 139
- [Radiographic Parameter Limits](#) on page 140
- [Warning messages](#) on page 141

## Restoring connection between generator and NX after generator failure

Details	<p>An error on the generator occurred. NX lost connection to the generator.</p> <p>An error message that no connection with the generator can be established is displayed on the Software Console.</p>
Cause	<p>After a shutdown of the generator, the communication between the X-ray generator and the NX workstation is broken.</p>
Brief Solution	<p>To set up the communication between the X-ray generator and the NX workstation:</p> <ol style="list-style-type: none"> <li>1. Switch off the X-ray generator at X-ray generator console.</li> <li>2. After some seconds, switch the X-ray generator back on.</li> <li>3. Select an empty thumbnail in the Image Overview pane of the Examination window.</li> <li>4. The error message disappears. This may take some time.</li> </ol> <p>If an error is indicated on the X-ray generator by a signal, repeat step 1 to 3.</p> <p>During startup of the NX application and the Software Console, the communication to the generator is set up and the self-test of the generator is triggered.</p>

## DR Detector is Exceeding the Maximum Working Temperature

Details	A message is displayed on NX indicating that the DR Detector is exceeding the maximum working temperature.
Cause	Due to ambient temperature conditions and the number of acquired images, the DR Detector's internal temperature may become too high.
Brief Solution	<ol style="list-style-type: none"><li>1. Power off the DR Detector.</li><li>2. Leave the DR Detector unpowered for at least one hour.</li><li>3. Stop the NX workstation.</li><li>4. Power on the DR Detector.</li><li>5. Start the NX workstation.</li></ol>

## DR detector must be recalibrated

Details	A message is displayed indicating that the DR detector must be recalibrated.
Cause	A DR detector must be recalibrated at regular interval.
Brief Solution	Follow the instructions in the user manual to calibrate the DR detector: <ul style="list-style-type: none"><li>• DR Detector Calibration Key User Manual, document 0134</li></ul>

## Radiographic Parameter Limits

---

Switching between small focus and large focus may have a delay of a few seconds to enable the filament to warm up before switching.

The settings of kV and mAs or of mA and ms are defined by an algorithm. The highest mA setting is used for which the kV can be reached by the system and the exposure time is not lower than 1 ms or the mAs value is not lower than 0.5 mAs. When the kV setting is changed, the value of mA and ms are adjusted automatically to keep the mAs value constant, within the boundaries of generator or X-ray tube limitations.

If the radiographic parameters limits are reached, a value of a radiographic parameter cannot be increased or decreased, or another value can be automatically adjusted:

- **Radiographic Parameters Limit.** A maximum or minimum radiographic parameter limit is reached. The value cannot be increased or decreased.
- **Generator Power Limit.** The generator power limit (kV x mA) is reached. The value of the selected parameter cannot be increased. When increasing the value of the other parameter, the value of the first parameter will automatically be decreased to keep the mAs value constant.
- **Space Charge.** The space charge limit in the selected X-ray tube is reached by changing the kV or mA values. An information message is displayed.
- **Instantaneous Power.** The instantaneous power limit of the X-ray tube (ratings limit or the X-ray tube is momentarily overheated) is reached by selecting some technique. An information message is displayed.

## Warning messages

---



**Warning:** Under certain conditions the system shows a dialog box in the middle of the tube head display containing a warning message with an error code. This message informs the user that either a problem has occurred or that a requested action cannot be performed. The user must contact the service organization. **Do not use the system until the problem is resolved.**

Details on the contents of messages can be found in the service documentation which is available to service personnel. Error codes look like this: "Error C 0x01", where "C" is a character that indicates where the problem is located:

- "T" Radiographic table
- "S" Floor mounted column

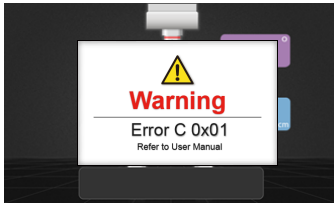

Figure 89: Warning message on the tube head display

## Product Information

---

- [Compatibility](#) on page 142
- [Connectivity](#) on page 143
- [Compliance](#) on page 144
- [Equipment Classification](#) on page 147
- [Patient data security](#) on page 150
- [Product Complaints](#) on page 151
- [Environmental protection](#) on page 152
- [System Documentation](#) on page 153
- [Training](#) on page 154
- [Technical Data](#) on page 155
- [Remarks for HF-emission and immunity](#) on page 172

## Compatibility

---

The system must only be used in combination with other equipment or components if these are expressly recognized by Agfa as compatible. A list of such equipment and components is available from Agfa service on request.

Changes or additions to the equipment must only be carried out by persons authorized to do so by Agfa. Such changes must comply with best engineering practice and all applicable laws and regulations that have the force of law within the jurisdiction of the hospital.

## Connectivity

---

The NX workstation is connected to the X-ray system to exchange X-ray exposure parameters.

The NX workstation requires a 100 Mbit ethernet network to exchange information with a number of other devices.

The NX workstation communicates with other devices in the hospital network using one of the following protocols:

- DICOM
- IHE

The NX workstation can be connected to a RIS system (input scheduling), a PACS system (output image/data management) and to a hardcopy device (output image).



**Note** The data connections between the components of the system are separate from the hospital network and should not be disconnected or modified.

## Compliance

---

The system is compliant with specific directives and standards.

- [General](#) on page 145
- [Safety](#) on page 145
- [Electromagnetic Compatibility](#) on page 146
- [X-Ray Safety](#) on page 146
- [X-Ray Accuracy](#) on page 146
- [Environmental Compliance](#) on page 146
- [Biocompatibility](#) on page 146
- [Usability](#) on page 146

## General

- The product has been designed in accordance with Regulation (EU) 2017/745 on medical devices (MDR)
- ISO 13485
- ISO 14971

## Safety

- IEC 60601-1
- IEC 60601-1-6, EN 60601-1-6
- CSA C22.2 60601-1
- AAMI ES 60601-1

## Essential performance

The product has no essential performance as defined in IEC 60601-1.

## Electromagnetic Compatibility

- IEC 60601-1-2, EN 60601-1-2

### For USA

This equipment has been tested and found to comply with the limits for a Class A digital device, pursuant to part 15 of the FCC Rules. These limits are designed to provide reasonable protection against harmful interference when the equipment is operated in a commercial environment. This equipment generates, uses, and can radiate radio frequency energy and, if not installed and used in accordance with the installation manual, may cause harmful interference to radio communications. Operation of this equipment in a residential area is likely to cause harmful interference in which case the user will be required to correct the interference at his own expense. If required, contact your local service organization.

### For Canada

This class A digital apparatus meets all requirements of the Canadian Interference-Causing Equipment Regulations.

## X-Ray Safety

- IEC 60601-1-3
- IEC 60601-2-54
- IEC 60601-2-28

### For USA

The system conforms to DHHS radiation Standards of 21CFR subchapter J as of the date of manufacture.

## X-Ray Accuracy

The system fulfills the X-ray radiation accuracy according EN IEC 60601-2-54 with a variation of max. 0.05 (5%).

## Environmental Compliance

- European Council Directive 1907/2006 (REACH)
- European Council Directive 2011/65/EU (RoHS 2)
- European Council Directive 2012/19/EU (WEEE)

## Biocompatibility

- EN ISO 10993-1

## Usability

- IEC/EN 62366
- IEC/EN 60601-1-6

## Equipment Classification

Per EN/IEC 60601-1, EN/IEC 60601-2-54, this device is classified as following:

**Table 32: Equipment classification**

Class I equipment	Equipment in which protection against electric shock does not rely on basic insulation only, but includes a fixed connection to mains power with protective earth conductor.
Type B applied part	A Type B applied part is one that provides a particular degree of protection against electric shock particularly regarding allowable leakage current and reliability of the protective earth protection.
Protection against ingress of solid foreign objects and water	IP10 This device is protected against solid objects with a size (diameter) of 50 mm or larger. This device is not protected against droplets of water.
Cleaning	See section on cleaning and disinfecting.
Disinfection	See section on cleaning and disinfecting.
Flammable anesthetics	This device is not suitable for use in the presence of a flammable anesthetic mixture with air, or in presence of a flammable anesthetic mixture with oxygen or nitrous oxide.
Operation	Continuous operation.

- [Foot pedals](#) on page 148
- [Applied Parts](#) on page 149

### Related information

[Cleaning and disinfecting](#) on page 55

## Foot pedals

**Table 33: Equipment classification of the foot pedals**

Water ingress	IPX1 The device is protected against dripping water.
---------------	---

## Applied Parts

Applied Parts refer to parts of the medical electrical equipment that in normal use necessarily comes into physical contact with the patient for the equipment to perform its function. This system includes the following Applied Parts:

### **Radiographic table**

- Tabletop of the Radiographic table
- Patient hand grips (optional)
- Lateral detector holder (optional)
- Compression belt (optional)

### **Radiographic wall stand**

- Front panel of the radiographic wall stand
- Lateral arm rest (optional)
- Patient hand grips (optional)

### **DR Detector**

- DR Detector

## Patient data security

---

The user must ensure that the patients' legal requirements are met and that the security of the patient data is guarded.

The user must define who can access patient data in which situations.

The user must have a strategy available on what to do with patient data in case of a disaster.

- [Requirements on the operating environment](#) on page 150

## Requirements on the operating environment

These operating environment requirements for information security and privacy (ISP), must be implemented and used in connection with the use of the Agfa medical device by the Customer (User). These are minimum requirements and designed to protect against unauthorised access that could hamper the device from functioning as intended.

Although Agfa has defined these ISP Operating Environment Requirements for implementation by the Customer, Agfa makes no warranties, expressed or implied regarding those ISP Operating Environment Requirements.

Agfa disclaims all liability if a security incident would occur despite the implementation of these ISP Operating Environment Requirements by the Customer.

Agfa reserves the right to revise these ISP Operating Environment Requirements and to make changes to them at any time. Possible revisions of the ISP Operating Environment Requirements will only be available in an electronic form, on request, via our website, by using the user documentation request form <http://www.agfahealthcare.com/global/en/library/index.jsp>.

The information presented herein is sensitive and is company confidential. Without written authority from Agfa, further distribution outside the company is not allowed.

- Perimeter firewalls shall be in place and appropriately configured in order to ensure that communications between medical devices and external resources are either denied or restricted to just the communications that are essential for the medical devices to properly function.
- Network Intrusion Detection/Prevention Systems (NIDS/NIPS) shall be in place at the perimeter and appropriately configured, in order to provide early warning of an attack attempt or successful compromise of a medical device as well as to attempt to prevent compromise of medical devices.
- A Network Time Protocol Server shall be configured in the medical devices in order to synchronize the time in the audit logs with the time on the NTP server.
- Medical devices shall be on an isolated network segment that restricts communication of the medical devices to the systems that are required for the device to function.
- Internal firewalls shall be put in place to improve upon network segmentation and to further restrict communications of medical devices to the systems (internal and external) that they need to interact with.
- Medical device configurations shall be backed up in a secure separate device.
- Security controls shall be put in place to ensure that physical access to medical devices is limited only to authorized individuals and that physical theft of the device is prohibited.
- An incident response plan detailing responsibilities and how to react and recover from incidents, shall be in place. Staff involved in the incident response plan shall be trained to respond appropriately and effectively.
- A formal user provisioning and de-provisioning process shall be implemented to enable the appropriate management of access rights to medical devices.
- Users shall be assigned unique accounts to medical devices.
- User access rights to medical devices shall be reviewed for appropriateness and corrected as needed, at regular intervals not exceeding once a year.

## Product Complaints

---

Any health care professional (for example a customer or a user) who has any complaints or has experienced any dissatisfaction with the quality, durability, reliability, safety, effectiveness, or performance of this product must notify Agfa.

If, during the use of this device or as a result of its use, a serious incident has occurred, please report it to the manufacturer and/or its authorised representative and to your national authority.

Manufacturer address:

Agfa Service Support - local support addresses and phone numbers are listed on [www.agfa.com](http://www.agfa.com)

Agfa - Septestraat 27, 2640 Mortsel, Belgium

Agfa - Fax +32 3 444 7094

## Environmental protection

---



**Figure 90: WEEE symbol**

### WEEE end user notice

The directive on Waste Electrical and Electronic Equipment (WEEE) aims to prevent the generation of electric and electronic waste and to promote the reuse, recycling and other forms of recovery. It therefore requires the collection of WEEE, recovery and reuse or recycling.

Due to the implementation into national law, specific requirements can be different within the European Member States. The WEEE symbol on the products, and/or accompanying documents means that used electrical and electronic products should not be treated as, or mixed with general household waste. For more detailed information about take-back and recycling of this product please contact your local service organization and/or dealer. The recycling of materials will help to conserve natural resources.



**Caution:** By ensuring this product is disposed of correctly, you will help prevent potential negative consequences for the environment and human health, which could otherwise be caused by inappropriate waste handling of this product.

## System Documentation

---

The Valory user documentation consists of

- Valory User Documentation on USB flash drive (digital media)
- MUSICA Acquisition workstation (NX) User Documentation on USB flash drive (digital media)
- User documentation for the supported DR Detectors

The Valory User Documentation USB flash drive contains:

- Valory User Manual (this document)
- DR Detector Calibration Key User manual, document 0134
- Exposure techniques for pediatric and adult use with Valory, document 0423

These documents can be installed on the NX workstation and be made available as part of the NX online help.

Other documentation available on the Valory User Documentation flash drive:

- DAP Datasheet
- X-ray Tube Documentation
- Collimator Datasheet
- AEC Datasheet
- X-ray Generator User Manual
- Grid Instruction for Use

The documentation shall be kept with the system for easy reference.

The most extensive configuration is described within this manual, including the maximum number of options and accessories. Not every function, option or accessory described may have been purchased or licensed on a particular piece of equipment.

Technical documentation is available in the product service documentation which is available from your local support organization.

The most recent version of this document is available on <http://www.agfahealthcare.com/global/en/library/index.jsp>

## Training

---

The user must have received adequate training on the safe and effective use of the system before attempting to work with it. Training requirements may vary from country to country. The user must make sure that training is received in accordance with local laws or regulations that have the force of law. Your local Agfa or dealer representative can provide further information on training.

The user must note the following information in the system documentation:

- Intended Use.
- Intended User.
- Safety Directions.

## Technical Data

---

- [Valory technical data](#) on page 156
- [Generator Technical Data](#) on page 157
- [Radiographic Table Technical Data](#) on page 159
- [Wall stand technical data](#) on page 160
- [Floor mounted column technical data](#) on page 161
- [X-Ray Tube Technical Data](#) on page 162
- [Bucky technical data](#) on page 165
- [Automatic Exposure Control \(AEC\) Technical Data](#) on page 166
- [Manual Collimator Technical Data](#) on page 167
- [Dose Area Product Meter \(IBA DAP\) Technical Data](#) on page 168
- [Portable DR detector technical data](#) on page 169
- [Portable DR detector technical data \(mounted fixed in the bucky\)](#) on page 170
- [NX workstation technical data](#) on page 171

## Valory technical data

Manufacturer	Agfa NV Septestraat 27 2640 Mortsel, Belgium
Type	5540/100
Power line	See Generator Technical Data
<b>Permanent filtration</b>	
E7254FX X-ray tube	2.8 mm Al @75kVp (+ 0.2 mm Al with DAP meter integrated in the collimator)
E7884X and E7252X X-ray tube	2.9 mm Al @ 75kVp (+ 0.2 mm Al with DAP meter integrated in the collimator)

### Environmental conditions

**Table 34: Environmental conditions for the X-ray system**

<b>Environmental Conditions (during storage and transport)</b>	
Temperature (ambient)	between -15° and 55° Celsius
Humidity (non condensing)	between 15 and 90 % relative humidity
Atmospheric pressure	between 70 and 106 kPa
<b>Environmental Conditions (during normal operation)</b>	
Temperature (ambient)	between 10° and 35° Celsius
Humidity (non condensing)	between 30 and 75 % relative humidity
Atmospheric pressure	between 70 and 106 kPa
Maximum altitude	3000 m

For overall system environmental conditions, the environmental conditions of the DR Detector should be taken into account. Refer to the related User Manual for environmental conditions for the DR Detector. When using the DR Detector inside the bucky, take into account that the temperature inside the bucky can be up to 8°C higher than the temperature in the X-ray room.

**Generator Technical Data**

Manufacturer	Spellman High Voltage Electronics GmbH Josef-Baumann-Strasse 23 D-44805 Bochum, Germany			
Supported Models	EDITOR HFe 401	EDITOR HFe 501	EDITOR HFe 601	EDITOR HFe 801
Max. Power	40 kW	50 kW	65 kW	80 kW
<b>Power input configurations and maximum input current</b>				
Power line 208-240 VAC Single-phase Two-phase (*)	208-240 VAC 50/60 Hz 275 A	-		
Power line 400 VAC Y-source	-	400V 3N~ PE (Y) 50/60 Hz		
		92 A	113 A	144 A
Power line 400/480 VAC Delta source	-	400/480V 3~PE (delta without N) 50/60Hz The power setting is selected during installation and printed on the type label.		
		79 A	97 A	124 A
<b>Power consumption</b>				
Maximum power	62 kVA	76 kVA	96 kVA	120 kVA
Average power (nominal)	20 kVA	24 kVA	35 kVA	44 kVA
Standby power (> 10 min and depending on input voltage, without MUSICA Acquisition workstation)	250 W	440-490 W	440-540 W	440-560 W
MUSICA Acquisition workstation (typical, without UPS and extra monitors)	45 W			
<b>High voltage output values</b>				
High voltage power output (at 0.1s)	500mA: 80kV 400mA: 100kV 320mA: 125kV 266mA: 150kV	625mA: 80kVp 500mA: 100kVp 400mA: 125kVp 330mA: 150kVp	800mA: 80kVp 650mA: 100kVp 520mA: 125kVp 430mA: 150kVp	800mA: 80kVp 800mA: 100kVp 640mA: 125kVp 530mA: 150kVp

kV-Range	40-150 kV		
mAs-Range	0.5-600 mAs		
mA-Range	10-500 mA	10-650 mA	10-800 mA
ms-Range	1-6300 ms		
<b>Mechanical data</b>			
Dimensions	550 mm x 630 mm x 970 mm (WxDxH)		
Weight	129 kg		
Duty cycle	The Generator duty cycle is continuous, but limits should be set during installation depending on the capacity of the X-ray tube.		

(\*) Split phase AC line with two hot phases, e.g. 240 VAC available as two 120 VAC hot phases

**Radiographic Table Technical Data**

Manufacturer	DK Medical Systems Co., LTD 52, ChupalSandan1-gil, Paengseong-eup, Pyeongtaek-si, Gyeonggi-do, Korea, 17998
Type	TE-90A TF-90A
<b>Dimensions</b>	
Radiographic table	TE-90A: 2206 mm x 800 mm x 530-820 mm (WxDxH) TF-90A: 2206 mm x 800 mm x 700 mm (WxDxH)
Tabletop	2206 mm x 800 mm (WxD)
Tabletop movement	Longitudinal, left and right 414 mm Transversal, back and front 150 mm
Bucky movement range	510 mm
Distance between tabletop and detector	≤ 81 mm
Tabletop attenuation equivalent mm Aluminum	≤ 1 mm A tabletop with attenuation < 0.7 mm is available as an option.
Weight of the radiographic table (including tabletop)	TE-90A: 215 kg TF-90A: 197 kg
Maximum load on the radiographic table	320 kg in the center of the table 100 kg at the end of the table

**Wall stand technical data**

Manufacturer	DK Medical Systems Co., LTD 52, ChupalSandan1-gil, Paengseong-eup, Pyeongtaek-si, Gyeonggi-do, Korea, 17998
Type	DS-90A
<b>Dimensions</b>	
Height	2351 mm
Width	650 mm
Depth	432 mm
Height of detector center	35 to 200 cm
Distance between front panel and detector	≤ 41 mm
Front panel attenuation equivalent mm Aluminum	≤ 0.7
<b>Weight</b>	
Radiographic wall stand	151 kg
Maximum load from patient or accessories on the wallstand, not to overload the brakes	20 kg

**Floor mounted column technical data**

Manufacturer	DK Medical Systems Co., LTD 52, ChupalSandan1-gil, Paengseong-eup, Pyeong-taek-si, Gyeonggi-do, Korea, 17998
Type	SF-90A
<b>Dimensions</b>	
Width x height x depth	250 cm x 224 cm x 130 cm
<b>Movement range</b>	
Longitudinal range	180 cm maximum
Transversal range	225 cm maximum
Vertical range	155 cm maximum
Beta rotation	± 180°
Alpha rotation (tilting)	± 180°
<b>Weight</b>	
Floor mounted column with X-ray tube head	310 kg

**X-Ray Tube Technical Data**

Manufacturer	Canon Electron Tubes & Devices Co., Ltd. 1385 Shimoishigami Otawara-Shi, Tochigi-Ken 324-8550 Japan
E7884X	X-ray Tube 12° 150 kVp dual focal spots 0.6 and 1.2 mm 300 KHU LS 20/50 kW (50Hz) 22/54 kW (60Hz) 7,24x10 <sup>6</sup> mAh@150kVp maximum load
E7252X	X-ray Tube 12° 150 kVp dual focal spots 0.6 and 1.2 mm 300 KHU LS 14/41 kW (50Hz) 16/45 kW (60Hz) HS 27/75 kW (180Hz) 7,24x10 <sup>6</sup> mAh@150kVp maximum load
E7254FX	X-ray Tube 12° 150 kVp dual focal spots 0.6 and 1.2 mm 400 KHU LS 22/55 kW (50Hz) 23/60 kW (60Hz) HS 40/102 kW (180Hz) 9,66x10 <sup>6</sup> mAh@150kVp maximum load

**Exposure parameters****Tube Voltage**

The tube voltage can be selected in steps of 1 kV in the range of 40 to 150 kV.

**mAs Product**

Step	mAs	Step	mAs	Step	mAs	Step	mAs
0	0.5	10	5.0	20	50	30	500
1	0.63	11	6.3	21	63	31	600
2	0.8	12	8.0	22	80		
3	1.0	13	10	23	100		
4	1.3	14	13	24	125		

Step	mAs	Step	mAs	Step	mAs	Step	mAs
5	1.6	15	16	25	160		
6	2.0	16	20	26	200		
7	2.5	17	25	27	250		
8	3.2	18	32	28	320		
9	4.0	19	40	29	400		

**Tube current [mA]**

Step	mA	Step	mA
0	10	10	100
1	13	11	125
2	16	12	160
3	20	13	200
4	25	14	250
5	32	15	320
6	40	16	400
7	50	17	500
8	63	18	650 (only for generator with 50 kW power or higher)
9	80	19	800 (only for generator with 65 kW power or higher)

**Exposure time [ms]**

Step	ms	Step	ms	Step	ms	Step	ms
0	1	10	13	20	130	30	1250
1	2	11	16	21	160	31	1600
2	3	12	20	22	200	32	2000
3	4	13	25	23	250	33	2500
4	5	14	32	24	320	34	3200
5	6	15	40	25	400	35	4000
6	7	16	50	26	500	36	5000
7	8	17	63	27	630	37	6300
8	10	18	80	28	800		
9	11	19	100	29	1000		



**Note** Not all exposure parameters may be available, depending on the configuration of X-ray generator, X-ray tube and DR Detector.

#### Maximum tube current [mA] at 100 kVp and 0.1 s

	<b>HFe 401 (40 kW)</b>	<b>HFe 501 (50 kW)</b>	<b>HFe 601 (65 kW)</b>	<b>HFe 801 (80 kW)</b>
E7884X	LSS: 400 mA	LSS: 500 mA	-	-
E7252X	LSS: 400 mA HSS: 400 mA	LSS: 450 mA HSS: 500 mA	HSS: 650 mA	-
E7254FX	LSS: 400 mA HSS: 400 mA	LSS: 500 mA HSS: 500 mA	HSS: 650 mA	HSS: 800 mA

- LSS: Low Speed Start option
- HSS: High Speed Start option

All Values are valid for 3-phase generator power line and large focal spot. Values for other exposure conditions can be determined using the technical data of the generator and the data sheets of the X-ray tubes.

In regular use these maximum exposure settings will not create doses that can cause deterministic effects. Effective patient doses for typical exposures are listed in Test Report for IEC 60601-1-3.



**Note** The accuracy for exposure parameter settings complies to EN IEC 60601-2-54 with absolute maximum of 10% for kV and an absolute maximum of 20% for mA.

#### Related information

[System Documentation](#) on page 153

**Bucky technical data**

Manufacturer	DK Medical Systems Co., LTD 52, ChupalSandan1-gil, Paengseong-eup, Pyeongtaek-si, Gyeonggi-do, Korea, 17998
Supported sizes	14x17 inch (43x35 cm) 17x17 inch (43x43 cm) in portrait and landscape orientation
Maximum load on the bucky drawer	10 kg

## Automatic Exposure Control (AEC) Technical Data

**Table 35: Varex AEC ionization chamber**

Manufacturer	Varex Imaging Americas Corp. 3835 Carnation Street Franklin Park, IL 60131 U.S.A.
Supported Type	ICX1945B
Description	3-field ionization chamber with electronics
Maximum dose rate	1.250 uGy/s
Exposure time range	1 ms to 6 s
Attenuation equivalent mm Aluminum	0.35mm @ 100kV (no filtration)
Dimensions	45 cm x 45 cm x 0.8 cm (WxLxH)

**Table 36: VacuTec AEC ionization chamber**

Manufacturer	VacuTec Messtechnik GmbH Dornblüthstrasse 13 D-01277 Dresden, Germany
Supported Type	70 145
Description	3-field ionization chamber with electronics
Exposure dose range	1 to 100 uGy
Exposure time range	1 ms to 10 s
Attenuation equivalent mm Aluminum	< 0.75
Dimensions	45 cm x 45 cm x 0.75 cm (WxLxH)

**Manual Collimator Technical Data**

Manufacturer	Ralco Via dei Tigli 13/G 20853 Biassono (MB), Italy
Supported type	R 221
Maximum radiation leakage	150 kVp – 4 mA
Inherent filtration	2 mm Aluminum equivalent
Added filtration	0mm Al 2mm Al 1mm Al + 0.1mm Cu 1mm Al + 0.2mm Cu
Maximum field Size at SID of 100 cm	48 cm x 48 cm
Dimensions	27.1 cm x 22.2 cm x 16.7 cm (WxDxH)
Weight	8.4 kg

**Dose Area Product Meter (IBA DAP) Technical Data**

Manufacturer	IBA Dosimetry GmbH Bahnhofstrasse 5 DE-90592 Schwarzenbruck
Supported Type	120-131 HS/RS485
Dose area product range	(0.1...99999999.99) cGy x cm <sup>2</sup>
DAP resolution	0.01 cGy x cm <sup>2</sup>
Active area	14.0 cm x 14.0 cm
Dimensions	17.9 cm x 16.6 cm x 1.7 cm (WxDxH)
Weight	approx. 220 g
Equivalent filtration of the ionization chamber at 70 kV	0.31 mm Al

**Correction factors for using the DAP meter on high altitude**

Environmental conditions	Correction factor
75 kPa (ca. 2500 m) 0° Celcius	1.26
75 kPa (ca. 2500 m) 20° Celcius	1.35
70 kPa (ca. 3000 m) 0° Celcius	1.35
70 kPa (ca. 3000 m) 20° Celcius	1.45

## **Portable DR detector technical data**

Refer to the DR Detector User Manual.

**Portable DR detector technical data (mounted fixed in the bucky)**

<b>Manufacturer</b>	
Manufacturer DR detector	Vieworks Co., Ltd. (Gwanyang-dong), 41-3, Burim-ro 170beon-gil, Dongan-gu, Anyang-si, Gyeonggi-do, Korea
Distributor DR detector	Agfa NV Septestraat 27, B-2640 Mortsel - Belgium
<b>Original manufacturer model name</b>	
XD 17	FXRD-4343VAW
XD*17	FXRD-4343VAW PLUS
<b>Electrical connection</b>	
Power adapter with USB Type-C cable	DC 18 V, max. 2.78 A
Power consumption	max. 24 W
<b>Network connection</b>	
Wireless connection	IEEE 802.11n/ac (2.4 GHz/5 GHz)
<b>Environmental conditions (during normal operation)</b>	
Room temperature	between 0 °C and +40 °C
Humidity (non condensing)	between 5% and 90% RH (non-condensing)
Atmospheric pressure	between 700 hPa and 1060 hPa
<b>Environmental conditions (during storage and transport)</b>	
Temperature (ambient)	between -15 °C and +55 °C
Humidity (non condensing)	between 5% and 90% (non-condensing)
Atmospheric pressure	between 500 and 1060 hPa
<b>Image acquisition</b>	
Image acquisition time (minimum cycle time)	4 s
Conversion screen	CsI
Pixel size	140 µm
Active pixel matrix	3072 x 3072
Effective pixel matrix	3048 x 3048
Detector type	amorphous silicium
Active area size	430 mm x 430 mm
Effective area size	426.7.0 mm x 426.7 mm

**NX workstation technical data**

Electrical connection	
Operating voltage	90 – 263 VAC
Mains fuse protection	5.5 A
Mains frequency	47 – 63 Hz
Power consumption	
Maximum power consumption	320 W
Power consumption during standby (incl monitor)	32 W
Power consumption	45 W

## Remarks for HF-emission and immunity

It is hereby certified that the device has interference suppression according to the EN 55011 Class A as well as the FCC Rules CFR 47 Part 15 Class A.

This device was tested for a normal hospital environment as described above.

The user of the device should ensure that it is used in such an environment.

This equipment has been tested and found to comply with the limits for a Class A digital device, pursuant to part 15 of the FCC Rules. These limits are designed to provide reasonable protection against harmful interference when the equipment is operated in a commercial environment. This equipment generates, uses and can radiate radio frequency energy and, if not installed and used in accordance with the instruction manual, may cause harmful interference to radio communications. Operation of this equipment in a residential area is likely to cause harmful interference in which case the user will be required to correct the interference at his own expense.



**Warning:** This device is intended for use by healthcare professionals only. This device may cause radio interference or may disrupt the operation of nearby equipment. It may be necessary to take mitigation measures, such as re-orienting or relocating the device or shielding the location.



**Warning:** The HF-emission and immunity can be influenced by connected data cables depending on length and the manner of installation.

**This device is intended for operation in the electromagnetic environment given below. The user of the device should ensure that it is used in such an environment.**

RF Emission Measurements	Agreement	Electromagnetic Environment Guidelines
High frequency RF emissions in accordance with CISPR 11	Group 1	The device uses high frequency energy exclusively for its internal functions. For this reason, its high frequency RF emission is very low and it is improbable that neighboring electronic equipment will be disrupted.
High frequency RF emissions in accordance with CISPR 11	Class A	The emissions characteristics of this equipment make it suitable for use in industrial areas and hospitals (CISPR 11 class A). If it is used in a residential environment (for which CISPR 11 class B is normally required) this equipment might not offer adequate protection to radio-frequency communication services. The user might need to take mitigation measures, such as relocating or re-orienting the equipment.

The Valory system is used in a professional healthcare facility / radiological environment. Environmental conditions are stated in the user manual.

This device was tested for a professional healthcare environment as described above. Nevertheless the HF-emission and immunity can be influenced by connected data cables depending on length and the manner of installation.

Resistance to Jamming Test	Test level of professional medical equipment and basic EMC standards	Electromagnetic Environment Guidelines

Discharge of static electricity in accordance with IEC 61000-4-2	± 8 kV contact discharge ± 2, 4, 8, 15 kV air discharge	Floors should consist of wood, concrete or ceramic tiles. The relative humidity must be at least 30%, if the floor is made of synthetic material.
Fast transient electrical disturbance variables / bursts in accordance with IEC 61000-4-4	± 2 kV mains ± 1 kV data lines	The quality of the voltage supplied should correspond to a typical commercial or clinical environment.
Impulse voltages (surges) in accordance with IEC 61000-4-5	± 1 kV line-line voltage ± 2 kV line-ground voltage	The quality of the voltage supplied should correspond to that of a typical commercial or clinical environment.
Voltage breakdown, short term interruptions and variations in the voltage supplied in accordance with IEC 61000-4-11	<ul style="list-style-type: none"> <li>• 0% <math>U_r</math> for ½ period</li> <li>• 0% <math>U_r</math> for 1 period</li> <li>• 70% <math>U_r</math> (30% breakdown of <math>U_r</math>) for 25 periods at 0°</li> <li>• 0% <math>U_r</math> for 250 periods</li> </ul>	<p>The quality of the voltage supply should correspond to that of a typical commercial or clinical environment.</p> <p>If the user wants the device to work continuously, even when the energy supply is interrupted, it is recommended to use an energy supply free of interruptions or a battery.</p>
Magnetic field at the supply frequency (50/60 Hz) in accordance with IEC 61000-4-8	30 A/m	Magnetic field at the network frequency should correspond to the typical values as they are in a commercial and clinical environment.
REMARK : $U_r$ is the alternating current in the network before the application of the test level.		

**This device is intended for operation in the electromagnetic environment given below. The user of the device should ensure that it is used in such an environment.**

<b>Tests of Resistance to Disruption</b>	<b>Test level of professional medical equipment and basic EMC standards</b>	<b>Electromagnetic Environment</b> Recommended protective distance:
Conducted high frequency disturbance variables in accordance with IEC 61000-4-6	3 V 150 kHz to 80 MHz 6 V within ISM bands	
Radiated high frequency disturbance variables in accordance with IEC 61000-4-3	3 V/m 80 MHz to 2.7 GHz	
RF communication	Refer to the section "Immunity to RF wireless communication equipment"	

		<p>Disruptions are possible near devices that carry the following symbol:</p> 
--	--	---

The field strength of stationary transmitters, such as base stations of radio telephones, mobile broadcasts for rural areas, amateur stations, and AM and FM radio transmitters, cannot be precisely predetermined theoretically. An investigation of the location is recommended, to ascertain the electromagnetic environment as a result of stationary high frequency transmitters. If the field strength of the device exceeds the test level given above, the device must be observed with regard to its normal operation at each place of use. In case of unusual performance characteristics, it can be necessary to take additional measures, such as the re-orientation of the device, for example.

**This device is intended for operation in an electromagnetic environment in which the radiated high frequency disturbance variables are monitored. The user of the device can help to prevent electromagnetic disruptions by maintaining the minimum distances between portable and mobile high frequency communication equipment (transmitters) and the device as recommended below, in accordance with the maximum output power of the communications equipment. See also the section with precautions on EMC.**

<b>Recommended Protective Distances between Portable and Mobile High Frequency Communication Equipment and the Device</b>			
Rated Power of the Transmitter W	Protective Distance in accordance with RF emission Frequency m		
	150 kHz to 80 MHz	80 MHz to 800 MHz	800 MHz to 2.7 GHz
	$d = 1.0 \sqrt{P}$	$d = 0.3 \sqrt{P}$	$d = 0.3 \sqrt{P}$
0.01	0.1	0.05	0.05
0.1	0.32	0.1	0.1
1	1.0	0.3	0.3
10	3.2	1.0	1.0
<p>The distance can be determined through the equation for each respective column.  P is the rated power of the transmitter in watts (W) according to the manufacturer information on the transmitter, only for transmitters where the rated power is not mentioned in the above table.  REMARK : These Guidelines may not be relevant in all situations. The dispersion of electromagnetic waves is influenced by absorption and reflections from buildings, objects and people.</p>			

- [Immunity to RF wireless communication equipment](#) on page 176
- [Precautions on EMC](#) on page 177
- [Cables, transducers and accessories](#) on page 178

- [Maintenance on EMC relevant parts](#) on page 179

**Immunity to RF wireless communication equipment**

<b>ISM Band (MHz)</b>	<b>Service</b>	<b>Distance (m)</b>	<b>Immunity test level (V/m)</b>
300-390	TETRA 400	0.3	27
430-470	GMRS 460; FRS 460	0.3	28
704-787	LTE Band 13, 17	0.3	9
800-960	GSM 800/900; TETRA 800, IDEN 820; CO- MA 850; LTE Band 5	0.3	28
1700-1990	GSM 1800; COMA 1900; GSM 1900; DECT; LTE Band 1, 3, 4, 25; UMTS	0.3	28
2400-2570	Bluetooth; WLAN; 802.11 b/g/n; RFID 2450; LTE Band 7	0.3	28
5100-5800	WLAN 802.11 a/n	0.3	9

## Precautions on EMC



**Warning:** Use of this equipment adjacent to or stacked with other equipment should be avoided because it could result in improper operation. If such use is necessary, this equipment and the other equipment should be observed to verify that they are operating normally.



**Warning:** Portable RF communications equipment (including peripherals such as antenna cables and external antennas) should be used no closer than 30 cm (12 inches) to any part of the system, including cables specified by the manufacturer. Otherwise, degradation of the performance of this equipment could result.



**Warning:** The DR detectors might be interfered with by other equipment.

## Cables, transducers and accessories

Cables, transducers and accessories which were tested and found to comply with the collateral standard IEC60601-1-2 (EMC):



**Caution:** Use of accessories, transducers and cables other than those specified or provided by the manufacturer of this equipment could result in increased electromagnetic emissions or decreased electromagnetic immunity of this equipment and result in improper operation.

Unless noted otherwise, available cable lengths are 16 m, 20 m and 24 m.

Table to control box	Type / connector / maximum length (m)	Remark
Foot pedal (optional)	UL2464SB 6x AWG20	part of the switch (Agfa service)
Main power cable	VCTF Cable 1.5SQ*3C	unshielded

Table to generator	Type / connector / maximum length (m)	Remark
AEC	CAT5e/CAT6 SFTP 20 m	internal basic wiring (Agfa service) A611881

Control box to operator room	Type / connector / maximum length (m)	Remark
COM A	3 x AWG24 9p D-SUB BU/BU 20 m	basic wiring; attention cross link
COM B	Standard RS-232 cable (9 Pin D-SUB) 20 m	basic wiring
LAN connection to the system	CAT 5e SF/UTP or F/UTP 20 m	basic wiring

## **Maintenance on EMC relevant parts**

Concerning the EMC safety (Electromagnetic Compatibility) of the Valory device, no relevant parts could be inspected by the operator. EMC relevant parts will be inspected from AFGA service engineer within the regular service interval until the end of lifetime. The needed verifications are described in the service manual.