

AGFA HEALTHCARE DICOM Conformance Statement

→ Agfa HealthCare Enterprise Imaging 8.1.x

Document No. 001531
Revision: 39
Livelihood NodeID: 53821200

When printed, this is NOT a controlled copy.

Document Information

Service-related contact information worldwide	All service-related contact information is available on this URL→	http://global.agfahealthcare.com/main/contact/

Issued by:
Agfa HealthCare
V&V Connectivity
Septestraat 27
B-2640 Mortsel
Belgium

tel: +32 3 444 9367
email: connectivity@agfa.com

Agfa shall not be liable for errors contained herein or for incidental or consequential damages in connection with the furnishing, performance or use of this publication. Agfa reserves the right to revise this publication and to make changes to its content at any time, without obligation to notify any person or entity of such revisions and changes. This publication may only be used in connection with the promotion, sales, installation and use of Agfa equipment.

Copyright © 2021
Agfa HealthCare
All rights reserved

Conformance Statement Overview

This document is a DICOM Conformance Statement for the DICOM Services of the Agfa HealthCare Enterprise Imaging 8.1.x further referred to as Enterprise Imaging.

Enterprise Imaging is comprised of several components that each provide certain DICOM capabilities conforming to the DICOM 3.0 2019e standard.

The following are the application entities (AE) that implement DICOM services in Enterprise Imaging:

- Enterprise Imaging Core Server AE
(comprised in Enterprise Imaging / Radiology Suite / Cardiology suite)
- Enterprise Imaging XERO Viewer AE (further referred to as Web Server for the server part and XERO Viewer for the display part)

These different optional components are not always included by default in every deployment. A brief description about Enterprise Imaging deployment is given in chapter 1.3: Enterprise Imaging - about.

Enterprise Imaging acts as a **service class provider (SCP)** for Verification, Storage, Storage Commitment, Query/Retrieve Service Classes, Modality Performed Procedure Step SOP Class and Modality Worklist.

Enterprise Imaging acts as a **service class user (SCU)** for Verification, Storage, Storage Commitment, Query/Retrieve Service Classes, Modality Performed Procedure Step SOP Class, Modality Worklist and Print.

Enterprise Imaging provides Standard Conformance to the SOP Classes listed in Table 1-1. This table lists the Network Services Supported as they appear in DICOM Part 2, Table A.1-2. The shaded items represent SOP classes that have been retired (so no longer appear in Supplement 64) but are still supported by Enterprise Imaging.

Table 1-1: Network Services Supported

SOP Class Name	SOP Class UID	Core Server / Web Server		XERO viewer & Enterprise Imaging desktops
		SCU	SCP	Display
Verification				
Verification	1.2.840.10008.1.1	Yes	Yes	Yes
Transfer				
Computed Radiography Image Storage	1.2.840.10008.5.1.4.1.1.1	Yes	Yes	Yes
Digital X-Ray Image Storage – For Presentation	1.2.840.10008.5.1.4.1.1.1.1	Yes	Yes	Yes
Digital X-Ray Image Storage – For Processing	1.2.840.10008.5.1.4.1.1.1.1.1	Yes	Yes	No
Digital Mammography X-Ray Image Storage – For Presentation	1.2.840.10008.5.1.4.1.1.1.2	Yes	Yes	Yes
Digital Mammography X-Ray Image Storage – For Processing	1.2.840.10008.5.1.4.1.1.1.2.1	Yes	Yes	No
Digital Intra-oral X-Ray Image Storage – For Presentation	1.2.840.10008.5.1.4.1.1.1.3	Yes	Yes	Yes
Digital Intra-oral X-Ray Image Storage – For Processing	1.2.840.10008.5.1.4.1.1.1.3.1	Yes	Yes	No
CT Image Storage	1.2.840.10008.5.1.4.1.1.2	Yes	Yes	Yes
Enhanced CT Image Storage	1.2.840.10008.5.1.4.1.1.2.1	Yes	Yes	Yes
Ultrasound Multi-frame Image Storage	1.2.840.10008.5.1.4.1.1.3.1	Yes	Yes	Yes
MR Image Storage	1.2.840.10008.5.1.4.1.1.4	Yes	Yes	Yes
Enhanced MR Image Storage	1.2.840.10008.5.1.4.1.1.4.1	Yes	Yes	Yes
MR Spectroscopy Storage	1.2.840.10008.5.1.4.1.1.4.2	Yes	Yes	No
Enhanced MR Color Image Storage	1.2.840.10008.5.1.4.1.1.4.3	Yes	Yes	Yes
Ultrasound Image Storage	1.2.840.10008.5.1.4.1.1.6.1	Yes	Yes	Yes
Enhanced US Volume Storage	1.2.840.10008.5.1.4.1.1.6.2	Yes	Yes	No
Secondary Capture Image Storage	1.2.840.10008.5.1.4.1.1.7	Yes	Yes	Yes
Multi-frame Single Bit Secondary Capture Image Storage	1.2.840.10008.5.1.4.1.1.7.1	Yes	Yes	Yes
Multi-frame Grayscale Byte Secondary Capture Image Storage	1.2.840.10008.5.1.4.1.1.7.2	Yes	Yes	Yes
Multi-frame Grayscale Word Secondary Capture Image Storage	1.2.840.10008.5.1.4.1.1.7.3	Yes	Yes	Yes
Multi-frame True Color Secondary Capture Image Storage	1.2.840.10008.5.1.4.1.1.7.4	Yes	Yes	Yes
12-lead ECG Waveform Storage	1.2.840.10008.5.1.4.1.1.9.1.1	Yes	Yes	Yes ¹
General ECG Waveform Storage	1.2.840.10008.5.1.4.1.1.9.1.2	Yes	Yes	Yes ¹

¹ Supported by XERO Viewer only

SOP Class Name	SOP Class UID	Core Server / Web Server		XERO viewer & Enterprise Imaging desktops
		SCU	SCP	Display
Ambulatory ECG Waveform Storage	1.2.840.10008.5.1.4.1.1.9.1.3	Yes	Yes	Yes ¹
Hemodynamic Waveform Storage	1.2.840.10008.5.1.4.1.1.9.2.1	Yes	Yes	No
Cardiac Electrophysiology Waveform Storage	1.2.840.10008.5.1.4.1.1.9.3.1	Yes	Yes	No
Basic Voice Audio Waveform Storage	1.2.840.10008.5.1.4.1.1.9.4.1	Yes	Yes	Yes ¹
General Audio Waveform Storage	1.2.840.10008.5.1.4.1.1.9.4.2	Yes	Yes	Yes ¹
Arterial Pulse Waveform Storage	1.2.840.10008.5.1.4.1.1.9.5.1	Yes	Yes	No
Respiratory Waveform Storage	1.2.840.10008.5.1.4.1.1.9.6.1	Yes	Yes	No
Grayscale Softcopy Presentation State Storage	1.2.840.10008.5.1.4.1.1.11.1	Yes	Yes	Yes
Color Softcopy Presentation State Storage	1.2.840.10008.5.1.4.1.1.11.2	Yes	Yes	Yes
Pseudo-Color Softcopy Presentation State Storage	1.2.840.10008.5.1.4.1.1.11.3	Yes	Yes	Yes
Blending Softcopy Presentation State Storage	1.2.840.10008.5.1.4.1.1.11.4	Yes	Yes	No
XA / XRF Grayscale Softcopy Presentation State Storage	1.2.840.10008.5.1.4.1.1.11.5	Yes	Yes	No
X-Ray Angiographic Image Storage	1.2.840.10008.5.1.4.1.1.12.1	Yes	Yes	Yes
Enhanced XA Image Storage	1.2.840.10008.5.1.4.1.1.12.1.1	Yes	Yes	Yes
X-Ray Radiofluoroscopic Image Storage	1.2.840.10008.5.1.4.1.1.12.2	Yes	Yes	Yes
Enhanced XRF Image Storage	1.2.840.10008.5.1.4.1.1.12.2.1	Yes	Yes	Yes
X-Ray 3D Angiographic Image Storage	1.2.840.10008.5.1.4.1.1.13.1.1	Yes	Yes	Yes
X-Ray 3D Craniofacial Image Storage	1.2.840.10008.5.1.4.1.1.13.1.2	Yes	Yes	Yes
Breast Tomosynthesis Image Storage	1.2.840.10008.5.1.4.1.1.13.1.3	Yes	Yes	Yes
Intravascular Optical Coherence Tomography Image Storage - For Presentation	1.2.840.10008.5.1.4.1.1.14.1	Yes	Yes	Yes ²
Intravascular Optical Coherence Tomography Image Storage - For Processing	1.2.840.10008.5.1.4.1.1.14.2	Yes	Yes	No ³
Nuclear Medicine Image Storage	1.2.840.10008.5.1.4.1.1.20	Yes	Yes	Yes
Raw Data Storage	1.2.840.10008.5.1.4.1.1.66	Yes	Yes	No ⁴
Spatial Registration Storage	1.2.840.10008.5.1.4.1.1.66.1	Yes	Yes	No
Spatial Fiducials Storage	1.2.840.10008.5.1.4.1.1.66.2	Yes	Yes	No

² Supported by XERO Viewer only

³ SOP Class is configured by default for Non-Display. If required it can be configured to be displayed.

⁴ Used by XERO for upload/display of encapsulated documents, other types not supported.

SOP Class Name	SOP Class UID	Core Server / Web Server		XERO viewer & Enterprise Imaging desktops
		SCU	SCP	Display
Deformable Spatial Registration Storage	1.2.840.10008.5.1.4.1.1.66.3	Yes	Yes	No
Segmentation Storage	1.2.840.10008.5.1.4.1.1.66.4	Yes	Yes	No
Surface Segmentation Storage	1.2.840.10008.5.1.4.1.1.66.5	Yes	Yes	No
Real World Value Mapping Storage	1.2.840.10008.5.1.4.1.1.67	Yes	Yes	No
VL Endoscopic Image Storage	1.2.840.10008.5.1.4.1.1.77.1.1	Yes	Yes	Yes
Video Endoscopic Image Storage	1.2.840.10008.5.1.4.1.1.77.1.1.1	Yes	Yes	Yes ⁵
VL Microscopic Image Storage	1.2.840.10008.5.1.4.1.1.77.1.2	Yes	Yes	Yes ⁶
Video Microscopic Image Storage	1.2.840.10008.5.1.4.1.1.77.1.2.1	Yes	Yes	Yes ⁵
VL Slide-Coordinates Microscopic Image Storage	1.2.840.10008.5.1.4.1.1.77.1.3	Yes	Yes	Yes ¹
VL Photographic Image Storage	1.2.840.10008.5.1.4.1.1.77.1.4	Yes	Yes	Yes
Video Photographic Image Storage	1.2.840.10008.5.1.4.1.1.77.1.4.1	Yes	Yes	Yes ⁵
Ophthalmic Photography 8 Bit Image Storage	1.2.840.10008.5.1.4.1.1.77.1.5.1	Yes	Yes	Yes
Ophthalmic Photography 16 Bit Image Storage	1.2.840.10008.5.1.4.1.1.77.1.5.2	Yes	Yes	Yes
Stereometric Relationship Storage	1.2.840.10008.5.1.4.1.1.77.1.5.3	Yes	Yes	No
Ophthalmic Tomography Image Storage	1.2.840.10008.5.1.4.1.1.77.1.5.4	Yes	Yes	Yes
VL Whole Slide Microscopy Image Storage	1.2.840.10008.5.1.4.1.1.77.1.6	Yes	Yes	No
Lensometry Measurements Storage	1.2.840.10008.5.1.4.1.1.78.1	Yes	Yes	No
Autorefractometry Measurements Storage	1.2.840.10008.5.1.4.1.1.78.2	Yes	Yes	No
Keratometry Measurements Storage	1.2.840.10008.5.1.4.1.1.78.3	Yes	Yes	No
Subjective Refraction Measurements Storage	1.2.840.10008.5.1.4.1.1.78.4	Yes	Yes	No
Visual Acuity Measurements Storage	1.2.840.10008.5.1.4.1.1.78.5	Yes	Yes	No
Spectacle Prescription Report Storage	1.2.840.10008.5.1.4.1.1.78.6	Yes	Yes	No
Ophthalmic Axial Measurements Storage	1.2.840.10008.5.1.4.1.1.78.7	Yes	Yes	No
Intraocular Lens Calculations Storage	1.2.840.10008.5.1.4.1.1.78.8	Yes	Yes	No
Macular Grid Thickness and Volume Report Storage	1.2.840.10008.5.1.4.1.1.79.1	Yes	Yes	No
Ophthalmic Visual Field Static	1.2.840.10008.5.1.4.1.1.80.1	Yes	Yes	No

⁵ EI Desktops cannot display video with MPEG-4 transfer syntaxes

⁶ Supported by XERO only as images, if video TSUID used, unsupported until 8.1.4

SOP Class Name	SOP Class UID	Core Server / Web Server		XERO viewer & Enterprise Imaging desktops
		SCU	SCP	Display
Perimetry Measurements Storage				
Basic Text SR Storage	1.2.840.10008.5.1.4.1.1.88.11	Yes	Yes	Yes
Enhanced SR Storage	1.2.840.10008.5.1.4.1.1.88.22	Yes	Yes	Yes
Comprehensive SR Storage	1.2.840.10008.5.1.4.1.1.88.33	Yes	Yes	Yes
Procedure Log Storage	1.2.840.10008.5.1.4.1.1.88.40	Yes	Yes	No
Mammography CAD SR Storage	1.2.840.10008.5.1.4.1.1.88.50	Yes	Yes	Yes ⁷
Key Object Selection Document Storage	1.2.840.10008.5.1.4.1.1.88.59	Yes	Yes	Yes
Chest CAD SR Storage	1.2.840.10008.5.1.4.1.1.88.65	Yes	Yes	No
X-Ray Radiation Dose SR Storage	1.2.840.10008.5.1.4.1.1.88.67	Yes	Yes	Yes
Colon CAD SR Storage	1.2.840.10008.5.1.4.1.1.88.69	Yes	Yes	No
Implantation Plan SR Storage	1.2.840.10008.5.1.4.1.1.88.70	Yes	Yes	No
Encapsulated PDF Storage	1.2.840.10008.5.1.4.1.1.104.1	Yes	Yes	Yes
Encapsulated CDA Storage	1.2.840.10008.5.1.4.1.1.104.2	Yes	Yes	Yes ⁸
Positron Emission Tomography Image Storage	1.2.840.10008.5.1.4.1.1.128	Yes	Yes	Yes
Enhanced PET Image Storage	1.2.840.10008.5.1.4.1.1.130	Yes	Yes	No
Basic Structured Display Storage	1.2.840.10008.5.1.4.1.1.131	Yes	Yes	No
RT Image Storage	1.2.840.10008.5.1.4.1.1.481.1	Yes	Yes	Yes ⁹
RT Dose Storage	1.2.840.10008.5.1.4.1.1.481.2	Yes	Yes	No
RT Structure Set Storage	1.2.840.10008.5.1.4.1.1.481.3	Yes	Yes	No
RT Beams Treatment Record Storage	1.2.840.10008.5.1.4.1.1.481.4	Yes	Yes	No
RT Plan Storage	1.2.840.10008.5.1.4.1.1.481.5	Yes	Yes	No
RT Brachy Treatment Record Storage	1.2.840.10008.5.1.4.1.1.481.6	Yes	Yes	No
RT Treatment Summary Record Storage	1.2.840.10008.5.1.4.1.1.481.7	Yes	Yes	No
RT Ion Plan Storage	1.2.840.10008.5.1.4.1.1.481.8	Yes	Yes	No
RT Ion Beams Plan Storage	1.2.840.10008.5.1.4.1.1.481.9	Yes	Yes	No
GE Private 3D Model Storage	1.2.840.113619.4.26	Yes	Yes	No
GE Private PET Raw Data Storage	1.2.840.113619.4.30	Yes	Yes	No
Dcm4che Encapsulated Document Storage	1.2.40.0.13.1.5.1.4.1.1.104.1	No	No	No
Agfa Basic Attribute Presentation State	1.2.124.113532.3500.7	No	No	No
Siemens CSA Non-Image	1.3.12.2.1107.5.9.1	Yes ¹⁰	Yes ¹⁰	No

⁷ Only supported by Diagnostic Desktop not XERO.

⁸ Supported by XERO Viewer only

⁹ XERO Viewer will display if the bit depth is <=16, but not for 32 bit grayscale pixels

¹⁰ Supported as of EI 8.1.2 SP5

SOP Class Name	SOP Class UID	Core Server / Web Server		XERO viewer & Enterprise Imaging desktops
		SCU	SCP	Display
Storage				
Philips 3D Private Presentation State Storage	1.3.46.670589.2.5.1.1	Yes	Yes	No
Philips Private MR Spectrum Storage	1.3.46.670589.11.0.0.12.1	Yes	Yes	No
Philips Private MR Series Data Storage	1.3.46.670589.11.0.0.12.2	Yes	Yes	No
Philips Private MR Examcard Data Storage	1.3.46.670589.11.0.0.12.4	Yes	Yes	No
Toshiba Aplio Ultrasound Private Storage	1.2.392.200036.9116.7.8.1.1.1	Yes	Yes	No
<i>Hardcopy Grayscale Image Storage (Retired)</i>	<i>1.2.840.10008.5.1.1.29</i>	Yes		No
<i>Hardcopy Color Image Storage (Retired)</i>	<i>1.2.840.10008.5.1.1.30</i>	Yes		No
<i>Nuclear Medicine Image Storage (Retired)</i>	<i>1.2.840.10008.5.1.4.1.1.5</i>	Yes	Yes	Yes
<i>Ultrasound Image Storage (Retired)</i>	<i>1.2.840.10008.5.1.4.1.1.6</i>	Yes	Yes	Yes
<i>Ultrasound Multi-frame Image Storage (Retired)</i>	<i>1.2.840.10008.5.1.4.1.1.3</i>	Yes	Yes	Yes
<i>X-Ray Angiographic Bi-plane Image Storage (Retired)</i>	<i>1.2.840.10008.5.1.4.1.1.12.3</i>	Yes	Yes	Yes ¹¹
<i>Standalone Overlay Storage (Retired)</i>	<i>1.2.840.10008.5.1.4.1.1.8</i>	Yes	Yes	No
<i>Standalone Curve Storage (Retired)</i>	<i>1.2.840.10008.5.1.4.1.1.9</i>	Yes	Yes	No
<i>Standalone Modality LUT Storage (Retired)</i>	<i>1.2.840.10008.5.1.4.1.1.10</i>	Yes	Yes	No
<i>Standalone VOI LUT Storage (Retired)</i>	<i>1.2.840.10008.5.1.4.1.1.11</i>	Yes	Yes	No
<i>Standalone PET Curve Storage (Retired)</i>	<i>1.2.840.10008.5.1.4.1.1.129</i>	Yes	Yes	No
<i>VL Image Storage (Retired)</i>	<i>1.2.840.10008.5.1.4.1.1.77.1</i>	Yes	Yes	Yes ¹¹
<i>VL Multi-frame Image Storage (Retired)</i>	<i>1.2.840.10008.5.1.4.1.1.77.2</i>	Yes	Yes	Yes ¹¹
Query/Retrieve				
Patient Root Query/Retrieve Information Model – FIND	1.2.840.10008.5.1.4.1.2.1.1	Yes	Yes	N/A
Patient Root Query/Retrieve Information Model – MOVE	1.2.840.10008.5.1.4.1.2.1.2	Yes	Yes	N/A
Study Root Query/Retrieve Information Model – FIND	1.2.840.10008.5.1.4.1.2.2.1	Yes	Yes	N/A
Study Root Query/Retrieve Information Model – MOVE	1.2.840.10008.5.1.4.1.2.2.2	Yes	Yes	N/A
Patient/Study Only Query/Retrieve Information Model – FIND	1.2.840.10008.5.1.4.1.2.3.1	Yes	Yes	N/A
Patient/Study Only	1.2.840.10008.5.1.4.1.2.3.2	Yes	Yes	N/A

¹¹ Supported by XERO Viewer only

SOP Class Name	SOP Class UID	Core Server / Web Server		XERO viewer & Enterprise Imaging desktops
		SCU	SCP	Display
Query/Retrieve Information Model – MOVE				
Workflow Management				
Storage Commitment Push Model	1.2.840.10008.1.20.1	Yes	Yes	N/A
Modality Worklist Information Model – Find	1.2.840.10008.5.1.4.31	No	Yes	N/A
Modality Performed Procedure Step SOP Class	1.2.840.10008.3.1.2.3.3	Yes	Yes	N/A
Instance Availability Notification	1.2.840.10008.5.1.4.33	Yes	No	
Print Management				
Basic Grayscale Print Management Meta SOP Class	1.2.840.10008.5.1.1.9	Yes	No	N/A
> Basic Film Session SOP Class	1.2.840.10008.5.1.1.1			
> Basic Film Box SOP Class	1.2.840.10008.5.1.1.2			
> Basic Grayscale Image Box SOP Class	1.2.840.10008.5.1.1.4			
> Printer SOP Class	1.2.840.10008.5.1.1.16			
Basic Color Print Management Meta SOP Class	1.2.840.10008.5.1.1.18	Yes	No	N/A
> Basic Film Session SOP Class	1.2.840.10008.5.1.1.1			
> Basic Film Box SOP Class	1.2.840.10008.5.1.1.2			
> Basic Color Image Box SOP Class	1.2.840.10008.5.1.1.4.1			
> Printer SOP Class	1.2.840.10008.5.1.1.16			
Presentation LUT SOP Class	1.2.840.10008.5.1.1.23	Yes	No	N/A

Enterprise Imaging supports the following Media services:

Table 1-2: Media Services Supported

Media Storage Application Profile	Write Files (FSC or FSU)	Read Files (FSR)
Core Server		
Compact Disk / DVD - Recordable		
STD-GEN-CD	Yes	Yes
Web Server		
ZIP		
STD-GEN-ZIP-MAIL	Yes	No
STD-GEN-SEC-ZIP-MAIL	Yes	No

Enterprise Imaging supports the following DICOMweb services:

Note:

Support for some RESTful DICOMweb services are experimental in version 8.1.x and may require assistance. Please contact your Agfa representative to discuss with Product Management for further details.

Table 1-3: DICOMweb Services Supported

DICOMweb services	User of Service (client)	Provider of Service (Server)
STorage Over the Web (STOW)		
STOW-RS - Store Instances	No	experimental
Query by ID for DICOM Objects (QIDO)		
QIDO-RS - Search for Studies	No	experimental
QIDO-RS - Search for Series	No	experimental
QIDO-RS - Search for Instances	No	experimental
Web Access to DICOM Objects (WADO)		
WADO - URI - Retrieve Imaging Document	Yes ¹²	Yes
WADO - URI - Retrieve Rendered Imaging Document	Yes ¹²	Yes
WADO - RS - Retrieve Study	No	experimental
WADO - RS - Retrieve Series	No	experimental
WADO - RS - Retrieve Instance	No	experimental
WADO - RS - Retrieve Frames	No	experimental
WADO - RS - Retrieve Bulkdata	No	experimental
WADO - RS - Retrieve Metadata	No	experimental

¹² Web server only

Table of Contents

1	Introduction	16
1.1	Revision Record	16
1.2	Purpose and Intended Audience of this Document	17
1.3	Enterprise Imaging - about	17
1.4	General Remarks	18
1.4.1	Integration and Validation Activities	18
1.4.2	Future Evolution.....	18
1.5	Acronyms and Abbreviations	18
1.6	Related Documents	20
2	Networking	21
2.1	Implementation Model	21
2.1.1	Application Data Flow Diagram	21
2.1.2	Functional Definitions of AE's	22
2.1.2.1	Enterprise Imaging Verification-SCU.....	22
2.1.2.2	Enterprise Imaging Storage-SCU.....	22
2.1.2.3	Enterprise Imaging Storage Commitment-SCU	22
2.1.2.4	Enterprise Imaging Modality Worklist-SCU	23
2.1.2.5	Enterprise Imaging Query/Retrieve-SCU	23
2.1.2.6	Enterprise Imaging Verification-SCP	23
2.1.2.7	Enterprise Imaging Storage Commitment-SCP	23
2.1.2.8	Enterprise Imaging Storage-SCP	23
2.1.2.9	Enterprise Imaging Modality Performed Procedure Step-SCP	24
2.1.2.10	Enterprise Imaging Modality Worklist-SCP	24
2.1.2.11	Enterprise Imaging Query/Retrieve-SCP and Enterprise Imaging Storage-SCU	24
2.1.2.12	Enterprise Imaging Print-SCU	25
2.2	AE Specifications.....	26
2.2.1	AE Specification: Storage-SCP, Storage Commitment (SCP and SCU), Query/Retrieve-SCP and Storage-SCU, Retrieve-SCU and Print-SCU	26
2.2.1.1	Default Transfer Syntaxes Supported	26
2.2.1.2	Extended Transfer Syntaxes Supported	26
2.2.1.3	SOP Classes Supported.....	27
2.2.1.4	Association Establishment Policies	34
2.2.1.4.1	General.....	34
2.2.1.4.2	Number of Associations	35
2.2.1.4.3	Asynchronous Nature.....	35
2.2.1.4.4	Implementation Identifying Information	35
2.2.1.4.5	Called/Calling AE Titles	36
2.2.1.5	Association Initiation Policies	37
2.2.1.5.1	Real World Activity – Enterprise Imaging Verification Communication-SCU.....	37
2.2.1.5.1.1	Description and Sequencing of Activity	37
2.2.1.5.1.2	Proposed Presentation Contexts	37
2.2.1.5.1.3	SOP Specific Conformance – Verification Communication	37
2.2.1.5.2	Real World Activity – Enterprise Imaging Storage Commitment Request-SCU.....	37
2.2.1.5.2.1	Description and Sequencing of Activity	38
2.2.1.5.2.2	Proposed Presentation Contexts	38
2.2.1.5.2.3	SOP Specific Conformance – Request Storage Commitment	38
2.2.1.5.3	Real World Activity – Enterprise Imaging Storage-SCU	40
2.2.1.5.3.1	Description and Sequencing of Activity	40

2.2.1.5.3.2	Proposed Presentation Contexts	40
2.2.1.5.3.3	SOP Specific Conformance – Store Objects	41
2.2.1.5.4	Real World Activity – Enterprise Imaging Query/Retrieve-SCU	41
2.2.1.5.4.1	Real World Activity – Core Server Query Remote AE	41
2.2.1.5.4.2	Real World Activity – Web Server Query Remote AE	45
2.2.1.5.4.3	Real World Activity – Web Server Retrieve SOP Instances	48
2.2.1.5.4.4	Real World Activity – Core Server Retrieve SOP Instances (SCU)	49
2.2.1.5.5	Real World Activity – Enterprise Imaging Modality Worklist-SCU	50
2.2.1.5.5.1	Real World Activity – Web Server Modality Worklist-SCU	50
2.2.1.5.6	Real World Activity – Enterprise Imaging Print-SCU	51
2.2.1.5.6.1	Description and Sequencing of Activity	51
2.2.1.5.6.2	Proposed Presentation Context	54
2.2.1.5.6.3	SOP Specific Conformance – Basic Grayscale Print Management Meta SOP Class	54
2.2.1.5.6.4	SOP Specific Conformance – Basic Color Print Management Meta SOP class	61
2.2.1.5.6.5	SOP Specific Conformance – Presentation LUT SOP Class	62
2.2.1.6	Association Acceptance Policies	63
2.2.1.6.1	Real World Activity – Verification Communication-SCP	64
2.2.1.6.1.1	Description and Sequencing of Activity	64
2.2.1.6.1.2	Accepted Presentation Contexts	64
2.2.1.6.1.3	SOP Specific Conformance - Verification Communication	64
2.2.1.6.1.4	Presentation Context Acceptance Criterion – Verification Communication	64
2.2.1.6.1.5	Transfer Syntax Selection Policies - Verification Communication	64
2.2.1.6.2	Real World Activity – Enterprise Imaging Storage Commitment-SCP	65
2.2.1.6.2.1	Description and Sequencing of Activity	65
2.2.1.6.2.2	Accepted Presentation Contexts	65
2.2.1.6.2.3	SOP Specific Conformance	66
2.2.1.6.2.4	Storage Commitment Result	66
2.2.1.6.2.5	Operations – Storage Commitment	67
2.2.1.6.2.6	Presentation Context Acceptance Criterion	68
2.2.1.6.2.7	Transfer Syntax Selection Policies	68
2.2.1.6.3	Real World Activity – Enterprise Imaging Storage-SCP	68
2.2.1.6.3.1	Description and Sequencing of Activity	68
2.2.1.6.3.2	Accepted Presentation Contexts	69
2.2.1.6.3.3	SOP Specific Conformance – Image or other Composite DICOM Object Sent by Remote AE (SCP)	70
2.2.1.6.3.4	Presentation Context Acceptance Criterion	71
2.2.1.6.3.5	Transfer Syntax Selection Policies	71
2.2.1.6.3.6	Enterprise Imaging Data Compression	71
2.2.1.6.4	Real World Activity – Modality Performed Procedure Step-SCP	74
2.2.1.6.4.1	Description and Sequencing of Activity	74
2.2.1.6.4.2	Accepted Presentation Contexts	75
2.2.1.6.4.3	SOP Specific Conformance	75
2.2.1.6.5	Real World Activity – Modality Worklist-SCP	79
2.2.1.6.5.1	Description and Sequencing of Activity	79
2.2.1.6.5.2	Accepted Presentation Contexts	79
2.2.1.6.5.3	SOP Specific Conformance	79
2.2.1.6.5.4	Presentation Context Acceptance Criterion – Modality Worklist (SCP)	82
2.2.1.6.5.5	Transfer Syntax Selection Policies – Modality Worklist (SCP)	82
2.2.1.6.6	Real World Activity – Enterprise Imaging Query/Retrieve-SCP	82
2.2.1.6.6.1	Description and Sequencing of Activity – Find Object (SCP)	82
2.2.1.6.6.2	Accepted Presentation Contexts – Find Object (SCP)	82
2.2.1.6.6.3	SOP Specific Conformance – Find Object (SCP)	83
2.2.1.6.6.4	Presentation Context Acceptance Criterion – Find Object (SCP)	86
2.2.1.6.6.5	Transfer Syntax Selection Policies – Find Object (SCP)	86

2.2.1.6.7	Real World Activity – Enterprise Imaging Move-SCP	86
2.2.1.6.7.1	Description and Sequencing of Activity	86
2.2.1.6.7.2	Accepted Presentation Contexts – Move Object (SCP)	86
2.2.1.6.7.3	SOP Specific Conformance – Move Object (SCP)	87
2.2.1.6.7.4	Presentation Context Acceptance Criterion – Move Object (SCP)	88
2.2.1.6.7.5	Transfer Syntax Selection Policies – Move Object (SCP)	88
2.3	Network Interfaces.....	89
2.3.1	Physical Medium Support.....	89
2.4	Configuration	90
2.4.1	Core Server Configuration.....	90
2.4.1.1	Core Server AE Title/Presentation Address Mapping	90
2.4.1.1.1	Core Server Local AE Titles	90
2.4.1.1.2	Core Server Remote AE Title.....	90
2.4.1.2	Core Server Parameters	90
3	Media Interchange	92
3.1	Core Server	92
3.1.1	Implementation Model	92
3.1.1.1	Application Data Flow.....	92
3.1.1.2	Functional Definitions of AE's.....	93
3.1.1.2.1	Functional Definition of Core Server Client Application Entity.....	93
3.1.1.3	Sequencing of Real-World Activities	93
3.1.1.3.1	Save to media	93
3.1.1.3.2	Importing from media	93
3.1.1.4	File Meta Information for Implementation Class and Version	93
3.1.2	AE Specification.....	93
3.1.2.1	Core Server Client AE	93
3.1.2.1.1	File Meta Information for the Core Server Client AE	94
3.1.2.1.2	Real World Activities	94
3.1.2.1.2.1	Activity – Export Exams	94
3.1.2.1.2.2	Activity – Load Exams	94
3.1.2.1.2.3	Activity – Import Exams	95
3.1.3	Augmented and Private Profiles	95
3.1.3.1	Augmented Profiles	95
3.1.3.2	Private Profiles	95
3.1.4	Media Configuration.....	95
3.2	Web Server.....	96
3.2.1	Implementation Model	96
3.2.1.1	Application Data Flow Diagram	96
3.2.1.2	Functional Definition of AEs	96
3.2.1.2.1	Export-FSC.....	96
3.2.1.3	Sequencing of Real World Activities	96
3.2.1.4	File Meta Information for Implementation Class and Version	96
3.2.2	AE Specifications.....	97
3.2.2.1	Export-FSC Specification	97
3.2.2.1.1	File Meta Information for the Export-FSC	97
3.2.2.1.2	Real World Activities	97
3.2.2.1.2.1	Real World Activity – Export Study	97
3.2.3	Augmented and Private Application Profiles	97
3.2.3.1	Augmented Application Profiles.....	97
3.2.3.1.1	Augmented Application Profile – STD-GEN-ZIP-MAIL	97
3.2.3.1.1.1	SOP Class Augmentations	97
3.2.3.1.1.2	Directory Augmentations	97
3.2.3.1.1.3	Other Augmentations	98
3.2.3.1.2	Augmented Application Profile STD-GEN-SEC-ZIP-MAIL.....	98
3.2.3.1.2.1	SOP Class Augmentations	98

3.2.3.1.2.2	Directory Augmentations	98
3.2.3.1.2.3	Other Augmentations	98
3.2.3.2	Private Application Profiles	98
3.2.4	Media Configuration	98
4	Support for Extended Character Sets	99
4.1	Core Server Support for Extended Character Sets	99
5	Security	100
5.1	Security Profiles	100
5.2	Association Level Security	100
5.3	Application Level Security	100
6	Support for DICOMweb Services	101
6.1	Scope	101
6.2	Use Cases	101
6.3	QIDO-RS	101
6.4	WADO-RS and WADO-URI	102
6.4.1	WADO-RS	102
6.4.2	WADO-URI	103
6.5	STOW-RS	104
6.6	CAPABILITIES Service	105
7	Annexes	106
7.1	IOD Contents	106
7.1.1	Created SOP Instance	106
7.1.2	Core Server	106
7.1.2.1	GSPS IOD	106
7.1.2.2	Key Object Selection Document IOD	107
7.1.2.3	Common Modules	107
7.1.2.4	GSPS Modules	109
7.1.2.5	Flags and Sessions Modules	112
7.1.3	Web Server	113
7.1.3.1	XC – VL Photographic Image IOD	113
7.1.3.2	XC – Video Photographic Image IOD	114
7.1.3.3	SR or ECG – Encapsulated PDF	114
7.1.3.4	AU – General Audio Waveform	114
7.1.3.5	DOC – RAW Data (Encapsulated)	115
7.1.3.6	Encapsulated CDA IOD	115
7.1.3.7	Grayscale Softcopy Presentation State (GSPS) IOD	115
7.1.3.8	Key Object Selection Document IOD	117
7.2	Usage of Attributes from Received IOD's	117
7.2.1	Core Server	117
7.2.2	Web Server	117
7.3	Attribute Mapping	118
7.4	Coerced/Modified fields	118
7.4.1	Core Server	118
7.4.1.1	Reassignment of private elements reserved blocks	118
7.4.2	Web Server	119
7.5	Data Dictionary of Private Attributes	119
7.6	Coded Terminology and Templates	119
7.6.1	Core Server	119

7.6.2	Web Server.....	119
7.7	Grayscale Image Consistency.....	119
7.8	Standard Extended/Specialized/Private SOP Classes.....	119
7.9	Private Transfer Syntaxes.....	119

1 INTRODUCTION

1.1 Revision Record

DICOM Conformance Statement Enterprise Imaging 8.1.x		
Revision Number	Date	Reason for Change
1.0	February 25, 2016	Initial version
1.1	May, 2016	Update after review cycle, add CSP Query SCU chapter
4	June, 2016	Update after review cycle Add Core Server Query SCU chapter Add missing Transfer Syntaxes, SOP Classes, Error Codes and Query Keys Update product naming: Core Server - Web Server
5	July, 2016	Update after review cycle
6	August, 2016	Update after review cycle – final version for publication
7	May 15, 2017	Correct display support For-Processing SOP Classes
8	August 23, 2017	Update chapter 4: Character Sets
9	January 22, 2018	Update Conformance Statement overview: add WebServices and MediaServices Add chapter 2.2.1.6.3.6: Enterprise Imaging Data Compression Update chapter 6: WADO, QIDO, STOW
10	March 02, 2018	Several minor updates after review cycle
11	June 26, 2018	Update for Enterprise Imaging 8.1.4: Image Compression on Ingestion (chapter 2.2.1.6.3.6)
12-13-14	August 30 to October 3 rd 2018	Update after review cycles – Add note for DICOMweb services in conformance statement overview and chapter 6. Image compression updates moved to 8.1.2 SP5
15-16	November 12, 2018 to January 25, 2019	Changes for DICOM Print
17-18-19	March 1 to 20, 2019	Update the Desktops display capabilities for the MPEG2 & MPEG-4 transfer syntaxes and Toshiba Aplio Ultrasound Private Storage SOP class
20	April 09, 2019	Update Chapter 7.8 for supported SOP Classes as SCU only
21-22	November 21 to 28, 2019	Update following sections: Chapter 2.2.1.6.4.1: remove MPPS SCU forwarding to another MPPS SCP Table 2-55: C-STORE Response Status Table 1-1 and Table 2-3: no display for MR Spectroscopy Storage
23-24-25	March 17 to 26, 2020	Update following sections: Table 2-55: added Error Code Table 2-66: added attributes Issuer of Patient ID and Issuer of Patient ID Qualifiers Sequence Table 2-72: Footnotes Table 7-3: Footnotes
26-27	April 16 to 17, 2020	Changes in following sections: Table 1-1 and Table 2-3: Supported Siemens CSA Non-image storage SOP class
28-29	May 19 to 20, 2020	Changes in following sections: Table 2-2, Table 2-13 and Table 2-53: Added MPEG-4 transfer syntaxes
32	June 9, 2020	Update Chapter 2.2.1.6.5: activity is Modality Worklist
33-34	August 5 to 7, 2020	Changes in following sections: Table 2-2, Table 2-13 and Table 2-52: Add note for JPEG 2000 transfer syntaxes

DICOM Conformance Statement Enterprise Imaging 8.1.x		
Revision Number	Date	Reason for Change
35-36-37	December 10 to 15, 2020	Supported compression rules as of Enterprise Imaging 8.1.5.x: Table 2-56: Segmentation Storage, RT Dose Storage and Enhanced US Volume Storage Table 2-57: Ultrasound Multi-frame Image Storage and Ultrasound Multi-frame Image Storage (Retired) Added Chapter 7.4.1.1: Reassignment of private elements reserved blocks
38-39	August 26 to September 8, 2021	Correction following sections: Table 1-1: Procedure Log Storage is supported by EI as SCU and as SCP Chapter 2.2.1.6.3.3: text change in paragraph Core Server Storage-SCP Table 2-71: Patient Birth Date Tag

1.2 Purpose and Intended Audience of this Document

This document is a DICOM Conformance Statement for the DICOM Services of the Agfa HealthCare Enterprise Imaging 8.1.x, further referred to as Enterprise Imaging.

The user of this document is involved with system integration and/or software design. We assume that the reader is familiar with the terminology and concepts that are used in the DICOM 3.0 standard and the IHE Technical Framework.

Readers not familiar with DICOM 3.0 terminology should first read the appropriate parts of the DICOM standard itself, prior to reading this conformance statement.

Although the use of this conformance statement, in conjunction with the DICOM 3.0 standard, is intended to facilitate communication between Enterprise Imaging and other DICOM devices, it is not sufficient to guarantee the interoperability of the connection. Section 1.3 outlines issues that need to be considered to ensure interoperability.

1.3 Enterprise Imaging - about

Enterprise Imaging is a care-centric interoperable, collaborative workflow platform of image management and repository solutions across the continuum of care. It improves physician awareness of a patient's complete imaging record through the EHR and promotes collaboration with other care givers in a multi-disciplinary environment.

Enterprise Imaging has different entry points in the care universe, by offering different solutions, based underneath on the same Consolidated Server Platform.

- Enterprise Imaging offers departmental solutions for different departments: radiology, cardiology, dermatology, ophthalmology, and more multi-specialties. This solution can be offered as a single department solution, span immediately multiple enterprise departments or used as a regional solution to optimize the collaboration and integration in the medical imaging domain.
- Enterprise Imaging offers a Universal viewer (XERO) which can be deployed with the Enterprise Imaging departmental solutions, or which can be deployed with a 3rd party PACS system, or Agfa's IMPAX PACS systems. This offering also gives you the capability to limit the deployment to a Universal viewer deployment, but also be extended to a combined Universal Viewer/departmental solution or a combined Universal Viewer/VNA deployment.
- Enterprise Imaging offers a VNA solution which facilitates vendor neutral, storage agnostic archiving services, extended with workflow management and non-DICOM data, which can be deployed separately or combined with a departmental solution or Universal XERO Viewer.

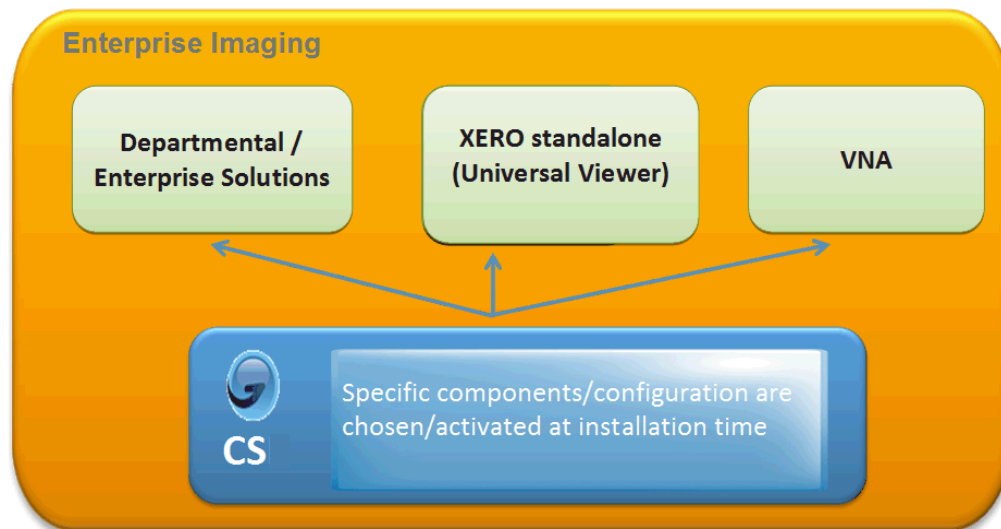

1.4 General Remarks

1.4.1 Integration and Validation Activities

The integration of any device into a system of interconnected devices goes beyond the scope of the DICOM 3.0 standard and this conformance statement when *interoperability* is desired. The responsibility for analyzing the applications requirements and developing a solution that integrates the Agfa equipment with other vendors' systems is the user's responsibility and should not be underestimated.

In some circumstances it might be necessary to perform a validation to make sure that functional interoperability between the Agfa equipment and non-Agfa devices works as expected. The user should ensure that any non-Agfa provider accepts responsibility for any validation required for their connection with the Agfa equipment.

1.4.2 Future Evolution

As the DICOM 3.0 standard evolves to meet the user's growing requirements and to incorporate new features and technologies, Agfa will follow the evolution of the standard. This evolution of the standard may require changes to devices that have implemented DICOM 3.0. The user should ensure that any non-Agfa provider, who connects with Agfa devices, also plans for future evolution of the DICOM standard. A refusal to do so may result in the loss of functionality and/or connectivity between the different products.

1.5 Acronyms and Abbreviations

Definitions, terms and abbreviations used in this document are defined within the different parts of the DICOM standard. Abbreviations and terms are as follows:

ADT	HL7 Admission, Discharge, and Transfer message
AE	DICOM Application Entity
AET	Application Entity Title
ACSE	Association Control Service Element
CAD	Computer Aided Detection
CD-R	Compact Disk Recordable
CS	Core Server
CSPS	Color Softcopy Presentation State

WS	Web Server
DICOM	Digital Imaging and Communications in Medicine
DM	Detached Management
FSC	File-Set Creator
FSU	File-Set Updater
FSR	File-Set Reader
GSDF	Grayscale Standard Display Function
GSPS	Grayscale Softcopy Presentation State
GUI	Graphical User Interface
HL7	Health Level 7
HTTP	HyperText Transfer Protocol
IE	Information Entity
IHE	Integrating the Healthcare Enterprise
IM	Information Model
IOD	(DICOM) Information Object Definition
ISO	International Organization of Standardization
KIN	Key Image Notes
MF	Multi-frame
MPPS	Modality Performed Procedure Step
MSPS	Modality Scheduled Procedure Step
MWL	Modality Worklist
NEMA	National Electrical Manufacturers Association
ORM	HL7 Order Request message
ORU	HL7 Observation Results - Unsolicited message
PACS	Picture Archive and Communications System
PDU	DICOM Protocol Data Unit
QIDO-RS	Query based on ID for DICOM Objects by RESTful services
RIS	Radiology Information System
RS	REST - Representational State Transfer
SC	Secondary Capture
SCU	DICOM Service Class User (DICOM client)
SCP	DICOM Service Class Provider (DICOM server)
SOP	DICOM Service-Object Pair
SR	Structured Report
STOW-RS	Store Over the Web by RESTful services
TCP/IP	Transmission Control Protocol / Internet Protocol
UID	Unique Identifier
UML	Unified Modeling Language
URI	Uniform Resource Identifier
UTF-8	Unicode Transformation Format - 8
VR	Value Representation
WADO-RS	Web Access of DICOM Objects by RESTful services
WADO-URI	Web Access of DICOM Objects

1.6

Related Documents

- [ACR-NEMA Digital Imaging and Communications in Medicine \(DICOM\) V3.0](#)
- [IHE Radiology Technical Framework](#)

2 NETWORKING

2.1 Implementation Model

2.1.1 Application Data Flow Diagram

The Application Data Flow Diagram in Figure 2.1-1 depicts the DICOM data flow to and from the individual application entities that are included in Enterprise Imaging. The tail of the arrow between a local AE and the remote real world activity indicates the party (AE or remote real world activity) that initiates the association negotiation.

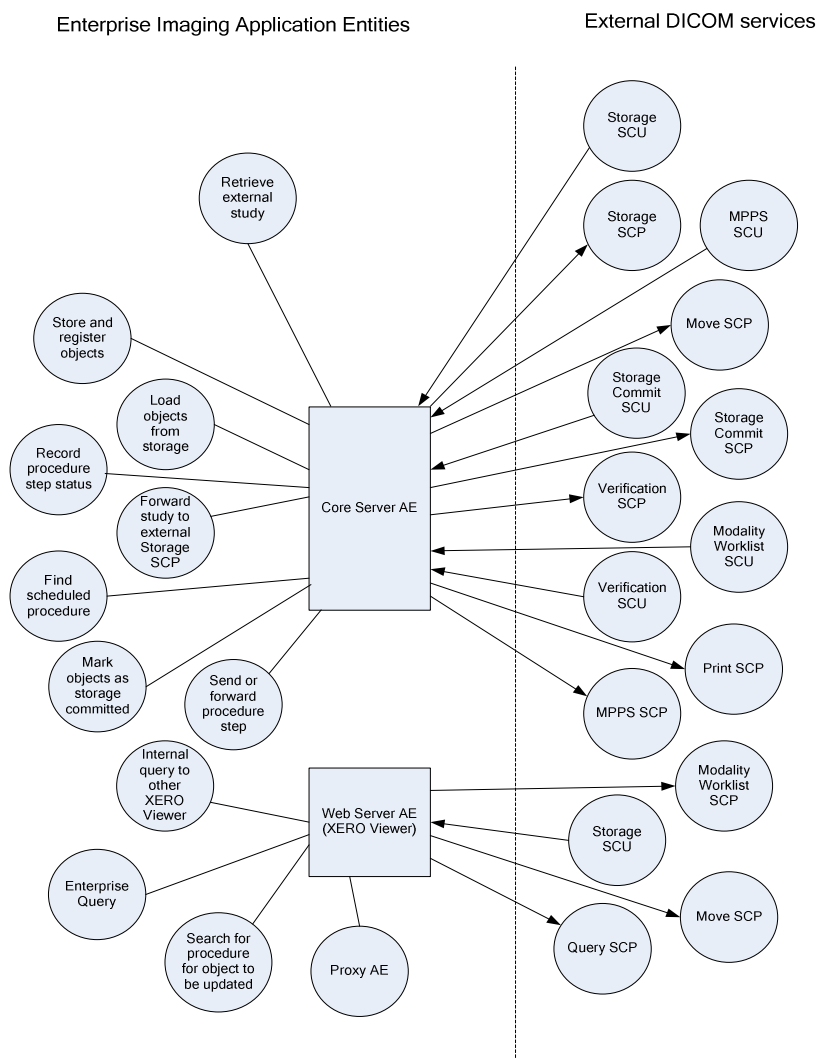

Figure 2.1-1: Functional Overview – Application Data Flow

Enterprise Imaging provides several different DICOM Application Entities:

Core Server AE can use different AE aliases per major DICOM feature, by default it is configured as a single AE. It provides the following service classes:

- Verification - SCU and SCP
- Storage - SCU and SCP

- Storage Commitment - SCU and SCP
- Query/Retrieve - SCU and SCP
- Modality Performed Procedure Step - SCU and SCP
- Modality Worklist SCP
- Print SCU

Web Server AE provides the following service classes:

- Verification-SCU
- Query/Retrieve-SCU
- Modality Worklist-SCU
- Storage-SCU and SCP
- Proxy SCP-as per Core Server AE SCP

2.1.2 Functional Definitions of AE's

The following sections contain a functional definition for each Application Entity that is part of the Enterprise Imaging. These definitions describe the functions to be performed by the AE, and the DICOM services used to accomplish these functions (both DICOM service classes and lower level DICOM services such as Association Services).

2.1.2.1 Enterprise Imaging Verification-SCU

The following Enterprise Imaging AE's implement the DICOM Verification Service Class as an SCU:

Core Server AE, Web Server AE

2.1.2.2 Enterprise Imaging Storage-SCU

The following Enterprise Imaging AE's implement the DICOM Storage Service Class as an SCU:

Core Server AE receives images and stores them to the Storage SCP or to an external Archive Storage SCP, depending on the deployment model.

Core Server AE will also send images to a remote storage SCP once it receives a Retrieve request.

Web Server AE receives uploaded DICOM and non-DICOM format images and converts them to DICOM and sends them to the Core Server storage SCP, or an external PACS storage SCP, depending on the configuration of storage endpoint.

Web Server AE performs, on a web based move request, a C-STORE to the specified SCP.

2.1.2.3 Enterprise Imaging Storage Commitment-SCU

The following Enterprise Imaging AE's implement the DICOM Storage Commitment Service Class as an SCU:

Depending on the deployment model, Core Server AE uses store and remember to VNA, as such, it implements the Storage Commitment-SCU to the VNA Storage Commitment-SCP. Core Server AE can also store towards external archive. As such it implements storage commitment-SCU to the external archive Storage Commitment-SCP as well.

2.1.2.4 Enterprise Imaging Modality Worklist-SCU

The following Enterprise Imaging AE's implement the DICOM Modality Worklist Service Class as an SCU:

Web Server AE - the Web Server Modality Worklist-SCU uses the Basic Worklist Management service to get required information to build its DICOM datasets.

It establishes an association with Enterprise Imaging Core Server Modality Worklist-SCP, performs a Find request, waits for responses, and then releases the association: XERO caches the association for re-use a certain length of time to avoid negotiation performance.

2.1.2.5 Enterprise Imaging Query/Retrieve-SCU

The following Enterprise Imaging AE's implement the DICOM Query/Retrieve Service Class as an SCU:

Core and Web Server Query/Retrieve-SCU act as a Service Class User of C-FIND to query for DICOM objects and C-MOVE to retrieve DICOM objects from a remote Query/Retrieve SCP, or from Core Server Query/Retrieve SCP.

Core and Web Server Query/Retrieve-SCU act as a Service Class User of C-Find to query for DICOM objects and C-Move to retrieve DICOM objects from an external archive.

2.1.2.6 Enterprise Imaging Verification-SCP

Core Server and Web Server implement the DICOM Verification Service Class as an SCP.

2.1.2.7 Enterprise Imaging Storage Commitment-SCP

The following Enterprise Imaging AE's implement the DICOM Storage Commitment Class as an SCP:

Core Server AE acts as Service Class Provider of Storage Commitment to take explicit responsibility for storing DICOM objects received until it archives to the VNA and receives confirmation that VNA has taken over this explicit responsibility.

2.1.2.8 Enterprise Imaging Storage-SCP

The following Enterprise Imaging AE's implement the DICOM Storage Class as an SCP:

Core Server AE stores a received image in its entirety in its internal data store. Enterprise Imaging stores each image with the File Meta Information attached to it. Enterprise Imaging extracts information about the images and stores this information within its internal database.

Web Server Storage SCP is always active and primarily used when Web Server initiates a C-MOVE to a remote retrieve SCP. Storage is temporary for the purpose of display and is not queryable or retrievable after the fact through any DICOM SCP services. Web Server can be configured to forward to, for example, to ensure that data is quickly available for display. Also, it can be used as an intermediate destination when a study is being requested from one system which is not DICOM connected to a second system, but where both systems are connected via the Web Server.

Web Server AE Storage-SCP stores a received image in its entirety in its internal data store for viewing. Web Server stores each image with the File Meta Information attached to it.

2.1.2.9 Enterprise Imaging Modality Performed Procedure Step-SCP

The following Enterprise Imaging AE's implement the DICOM Modality Performance Procedure Step Class as an SCP:

Core Server AE acts as a Service Class Provider of MPPS to receive MPPS.

Details: The MPPS SCP Application Entity waits for another application to connect at the presentation address configured for its Application Entity Title. When another application connects, the MPPS SCP AE expects it to be a DICOM application.

The MPPS SCP AE will accept Associations with Presentation Contexts for SOP Class of Modality Performed Procedure Step SOP Class.

Once it receives a Create (N-Create) or an Update (N-Set) request, the MPPS SCP AE will store the MPPS or update an existing MPPS locally.

2.1.2.10 Enterprise Imaging Modality Worklist-SCP

The following Enterprise Imaging AE's implement the DICOM Modality Worklist Class as an SCP:

Core Server AE acts as a Service Class Provider of MWL to receive MWL Query.

Details: The MWL SCP Application Entity waits for another application to connect at the presentation address configured for its Application Entity Title. When another application connects, the MWL SCP AE expects it to be a DICOM application.

The MWL SCP AE will accept Associations with Presentation Contexts for SOP Class of Modality Worklist Query SOP Class.

Once it receives a Query (C-Find) request, the MWL SCP AE will search the local database with worklist items that match the query constraints and return the items in the response.

2.1.2.11 Enterprise Imaging Query/Retrieve-SCP and Enterprise Imaging Storage-SCU

The following Enterprise Imaging AE's implement the DICOM Query/Retrieve Class as an SCP and a DICOM Storage Class as an SCU:

Core Server AE responds to queries and retrieves based on the records stored in its database.

The Query/Retrieve-SCP Application Entity waits for another application to connect at the presentation address configured for its Application Entity Title. When another application connects, the Query/Retrieve-SCP AE expects it to be a DICOM application.

The Query/Retrieve-SCP AE will accept Associations with Presentation Contexts for SOP Classes of the Verification and Query/Retrieve Service Classes.

Once it receives a Retrieve (Move) request, the Query/Retrieve-SCP AE will initiate a new association and send the requested instances to the Move Destination AE. The new association is handled by the Storage-SCU.

When a remote AE initiates an association with Enterprise Imaging and sends a query (Find) request, Enterprise Imaging will search the database for possible matches with composite SOP instances. The results of the query are returned to the remote AE using the same association.

2.1.2.12 Enterprise Imaging Print-SCU

Enterprise Imaging implements the DICOM Print Service Class as an SCU.

Depending on the selected Image Display Format (or Layout), the DICOM Print SCU sends one or more images and Print Management Information to a Remote Application Entity for printing.

At the request of the user of the system DICOM Print AE (SCU) initiates an association with a remote printer AE (SCP) and sends printing requests of a film session with one or more Basic Film Box(es) referring to one or more Basic Image Box(es) to the printer.

2.2 AE Specifications

This section outlines the specifications for each of the Application Entities that are part of Enterprise Imaging.

2.2.1 AE Specification: Storage-SCP, Storage Commitment (SCP and SCU), Query/Retrieve-SCP and Storage-SCU, Retrieve-SCU and Print-SCU

2.2.1.1 Default Transfer Syntaxes Supported

The Enterprise Imaging Storage-SCP provides Standard Conformance to the default transfer syntaxes listed in the following table:

Table 2-1: Default Transfer Syntaxes

Transfer Syntax	UID	SOP Class
Implicit VR Little Endian	1.2.840.10008.1.2	not Video

2.2.1.2 Extended Transfer Syntaxes Supported

The Enterprise Imaging Storage-SCP provides Standard Conformance to the extended transfer syntaxes listed in Table 2-2 for the purposes of **storage** and **retrieval**.

Table 2-2: Extended Transfer Syntaxes

Transfer Syntax	UID	SOP Class
Explicit VR Little Endian ¹³	1.2.840.10008.1.2.1	not Video
Deflated Explicit VR Little Endian	1.2.840.10008.1.2.1.99	only Image
<i>Explicit VR Big Endian (Retired)</i>	<i>1.2.840.10008.1.2.2</i>	<i>only Image</i>
JPEG Process 1, baseline, lossy (8 bit)	1.2.840.10008.1.2.4.50	only Image
JPEG Process 2,4, extended lossy (12 bit)	1.2.840.10008.1.2.4.51	only Image
JPEG Process 14, lossless, Non-Hierarchical	1.2.840.10008.1.2.4.57	only Image
JPEG Process 14, selection value 1, lossless, Non-Hierarchical, First-Order Prediction	1.2.840.10008.1.2.4.70	only Image
JPEG-LS Lossless	1.2.840.10008.1.2.4.80	only Image
JPEG-LS Lossy (Near-Lossless)	1.2.840.10008.1.2.4.81	only Image
JPEG 2000 (Lossless Only) ¹⁴	1.2.840.10008.1.2.4.90	only Image
JPEG 2000 ¹⁴	1.2.840.10008.1.2.4.91	only Image
RLE Lossless	1.2.840.10008.1.2.5	only Image
MPEG2 Main Profile @ Main Level	1.2.840.10008.1.2.4.100	only Video ¹⁵
MPEG2 Main Profile @ High Level*	1.2.840.10008.1.2.4.101	only Video ¹⁵
MPEG-4 AVC/H.264 High Profile / Level 4.1*	1.2.840.10008.1.2.4.102	only Video ¹⁵
MPEG-4 AVC/H.264 BD compatible High Profile / Level 4.1*	1.2.840.10008.1.2.4.103	only Video ¹⁵

¹³ LEE (Explicit Little Endian) is used for all group 2 elements including File Meta Information.

¹⁴ Default support for these transfer syntaxes was removed as of 8.1.4. If these transfer syntaxes are required at a site, they can be added, though customers are encouraged to instead adopt the other supported transfer syntaxes, such as standard JPEG lossless.

¹⁵ Cannot be requested in non-original transfer syntax.

Transfer Syntax	UID	SOP Class
MPEG-4 AVC/H.264 High Profile / Level 4.2*	1.2.840.10008.1.2.4.104 ¹⁶	only Video ¹⁵
MPEG-4 AVC/H.264 High Profile / Level 4.2*	1.2.840.10008.1.2.4.105 ¹⁶	only Video ¹⁵

* **MPEG-4 and MPEG2 High Level Transfer Syntaxes are supported by Core Server only for Storage (no display)**

2.2.1.3 SOP Classes Supported

The Enterprise Imaging AE's provides Standard Conformance to the SOP Classes listed in Table 2-3. The shaded items represent SOP classes that have been retired (so no longer appear in Supplement 64) but are still supported by the Enterprise Imaging AE's.

If the **User of Service (SCU)** or the **Provider of Service (SCP)** column has the value "Option", then the functionality is either configurable or can be purchased as an option. The **Display** column indicates whether or not the Core Server AE Client (desktops) or XERO Viewer will display the DICOM objects.

Table 2-3: SOP Classes for Enterprise Imaging AE's

SOP Class Name	SOP Class UID	Core Server / Web Server		XERO viewer & Enterprise Imaging desktops
		SCU	SCP	Display
Verification				
Verification	1.2.840.10008.1.1	Yes	Yes	Yes
Transfer				
Computed Radiography Image Storage	1.2.840.10008.5.1.4.1.1.1	Yes	Yes	Yes
Digital X-Ray Image Storage – For Presentation	1.2.840.10008.5.1.4.1.1.1.1	Yes	Yes	Yes
Digital X-Ray Image Storage – For Processing	1.2.840.10008.5.1.4.1.1.1.1.1	Yes	Yes	No
Digital Mammography X-Ray Image Storage – For Presentation	1.2.840.10008.5.1.4.1.1.1.2	Yes	Yes	Yes
Digital Mammography X-Ray Image Storage – For Processing	1.2.840.10008.5.1.4.1.1.1.2.1	Yes	Yes	No
Digital Intra-oral X-Ray Image Storage – For Presentation	1.2.840.10008.5.1.4.1.1.1.3	Yes	Yes	Yes
Digital Intra-oral X-Ray Image Storage – For Processing	1.2.840.10008.5.1.4.1.1.1.3.1	Yes	Yes	No
CT Image Storage	1.2.840.10008.5.1.4.1.1.2	Yes	Yes	Yes
Enhanced CT Image Storage	1.2.840.10008.5.1.4.1.1.2.1	Yes	Yes	Yes
Ultrasound Multi-	1.2.840.10008.5.1.4.1.1.3.1	Yes	Yes	Yes

¹⁶ Supported as of EI 8.1.2 SP5

SOP Class Name	SOP Class UID	Core Server / Web Server		XERO viewer & Enterprise Imaging desktops
		SCU	SCP	Display
frame Image Storage				
MR Image Storage	1.2.840.10008.5.1.4.1.1.4	Yes	Yes	Yes
Enhanced MR Image Storage	1.2.840.10008.5.1.4.1.1.4.1	Yes	Yes	Yes
MR Spectroscopy Storage	1.2.840.10008.5.1.4.1.1.4.2	Yes	Yes	No
Enhanced MR Color Image Storage	1.2.840.10008.5.1.4.1.1.4.3	Yes	Yes	Yes
Ultrasound Image Storage	1.2.840.10008.5.1.4.1.1.6.1	Yes	Yes	Yes
Enhanced US Volume Storage	1.2.840.10008.5.1.4.1.1.6.2	Yes	Yes	No
Secondary Capture Image Storage	1.2.840.10008.5.1.4.1.1.7	Yes	Yes	Yes
Multi-frame Single Bit Secondary Capture Image Storage	1.2.840.10008.5.1.4.1.1.7.1	Yes	Yes	Yes
Multi-frame Grayscale Byte Secondary Capture Image Storage	1.2.840.10008.5.1.4.1.1.7.2	Yes	Yes	Yes
Multi-frame Grayscale Word Secondary Capture Image Storage	1.2.840.10008.5.1.4.1.1.7.3	Yes	Yes	Yes
Multi-frame True Color Secondary Capture Image Storage	1.2.840.10008.5.1.4.1.1.7.4	Yes	Yes	Yes
12-lead ECG Waveform Storage	1.2.840.10008.5.1.4.1.1.9.1.1	Yes	Yes	Yes ¹⁷
General ECG Waveform Storage	1.2.840.10008.5.1.4.1.1.9.1.2	Yes	Yes	Yes ¹⁷
Ambulatory ECG Waveform Storage	1.2.840.10008.5.1.4.1.1.9.1.3	Yes	Yes	Yes ¹⁷
Hemodynamic Waveform Storage	1.2.840.10008.5.1.4.1.1.9.2.1	Yes	Yes	No
Cardiac Electrophysiology Waveform Storage	1.2.840.10008.5.1.4.1.1.9.3.1	Yes	Yes	No
Basic Voice Audio Waveform Storage	1.2.840.10008.5.1.4.1.1.9.4.1	Yes	Yes	Yes ¹⁷
General Audio Waveform Storage	1.2.840.10008.5.1.4.1.1.9.4.2	Yes	Yes	Yes ¹⁷
Arterial Pulse Waveform Storage	1.2.840.10008.5.1.4.1.1.9.5.1	Yes	Yes	No
Respiratory Waveform Storage	1.2.840.10008.5.1.4.1.1.9.6.1	Yes	Yes	No
Grayscale Softcopy Presentation State	1.2.840.10008.5.1.4.1.1.11.1	Yes	Yes	Yes

¹⁷ Supported by XERO Viewer only

SOP Class Name	SOP Class UID	Core Server / Web Server		XERO viewer & Enterprise Imaging desktops
		SCU	SCP	Display
Storage				
Color Softcopy Presentation State Storage	1.2.840.10008.5.1.4.1.1.11.2	Yes	Yes	Yes
Pseudo-Color Softcopy Presentation State Storage	1.2.840.10008.5.1.4.1.1.11.3	Yes	Yes	Yes
Blending Softcopy Presentation State Storage	1.2.840.10008.5.1.4.1.1.11.4	Yes	Yes	No
XA / XRF Grayscale Softcopy Presentation State Storage	1.2.840.10008.5.1.4.1.1.11.5	Yes	Yes	No
X-Ray Angiographic Image Storage	1.2.840.10008.5.1.4.1.1.12.1	Yes	Yes	Yes
Enhanced XA Image Storage	1.2.840.10008.5.1.4.1.1.12.1.1	Yes	Yes	Yes
X-Ray Radiofluoroscopic Image Storage	1.2.840.10008.5.1.4.1.1.12.2	Yes	Yes	Yes
Enhanced XRF Image Storage	1.2.840.10008.5.1.4.1.1.12.2.1	Yes	Yes	Yes
X-Ray 3D Angiographic Image Storage	1.2.840.10008.5.1.4.1.1.13.1.1	Yes	Yes	Yes
X-Ray 3D Craniofacial Image Storage	1.2.840.10008.5.1.4.1.1.13.1.2	Yes	Yes	Yes
Breast Tomosynthesis Image Storage	1.2.840.10008.5.1.4.1.1.13.1.3	Yes	Yes	Yes
Intravascular Optical Coherence Tomography Image Storage - For Presentation	1.2.840.10008.5.1.4.1.1.14.1	Yes	Yes	Yes ¹⁷
Intravascular Optical Coherence Tomography Image Storage - For Processing	1.2.840.10008.5.1.4.1.1.14.2	Yes	Yes	No ¹⁸
Nuclear Medicine Image Storage	1.2.840.10008.5.1.4.1.1.20	Yes	Yes	Yes
Raw Data Storage	1.2.840.10008.5.1.4.1.1.66	Yes	Yes	No ¹⁹
Spatial Registration Storage	1.2.840.10008.5.1.4.1.1.66.1	Yes	Yes	No
Spatial Fiducials Storage	1.2.840.10008.5.1.4.1.1.66.2	Yes	Yes	No

¹⁸ SOP Class is configured by default for Non-Display. If required it can be configured to be displayed.

¹⁹ Used by XERO for upload/display of encapsulated documents, other types not supported.

SOP Class Name	SOP Class UID	Core Server / Web Server		XERO viewer & Enterprise Imaging desktops
		SCU	SCP	Display
Deformable Spatial Registration Storage	1.2.840.10008.5.1.4.1.1.66.3	Yes	Yes	No
Segmentation Storage	1.2.840.10008.5.1.4.1.1.66.4	Yes	Yes	No
Surface Segmentation Storage	1.2.840.10008.5.1.4.1.1.66.5	Yes	Yes	No
Real World Value Mapping Storage	1.2.840.10008.5.1.4.1.1.67	Yes	Yes	No
VL Endoscopic Image Storage	1.2.840.10008.5.1.4.1.1.77.1.1	Yes	Yes	Yes
Video Endoscopic Image Storage	1.2.840.10008.5.1.4.1.1.77.1.1.1	Yes	Yes	Yes ²⁰
VL Microscopic Image Storage	1.2.840.10008.5.1.4.1.1.77.1.2	Yes	Yes	Yes ²¹
Video Microscopic Image Storage	1.2.840.10008.5.1.4.1.1.77.1.2.1	Yes	Yes	Yes ²⁰
VL Slide-Coordinates Microscopic Image Storage	1.2.840.10008.5.1.4.1.1.77.1.3	Yes	Yes	Yes ¹⁷
VL Photographic Image Storage	1.2.840.10008.5.1.4.1.1.77.1.4	Yes	Yes	Yes
Video Photographic Image Storage	1.2.840.10008.5.1.4.1.1.77.1.4.1	Yes	Yes	Yes ²⁰
Ophthalmic Photography 8 Bit Image Storage	1.2.840.10008.5.1.4.1.1.77.1.5.1	Yes	Yes	Yes
Ophthalmic Photography 16 Bit Image Storage	1.2.840.10008.5.1.4.1.1.77.1.5.2	Yes	Yes	Yes
Stereometric Relationship Storage	1.2.840.10008.5.1.4.1.1.77.1.5.3	Yes	Yes	No
Ophthalmic Tomography Image Storage	1.2.840.10008.5.1.4.1.1.77.1.5.4	Yes	Yes	Yes
VL Whole Slide Microscopy Image Storage	1.2.840.10008.5.1.4.1.1.77.1.6	Yes	Yes	No
Lensometry Measurements Storage	1.2.840.10008.5.1.4.1.1.78.1	Yes	Yes	No
Autorefractive Measurements Storage	1.2.840.10008.5.1.4.1.1.78.2	Yes	Yes	No
Keratometry Measurements Storage	1.2.840.10008.5.1.4.1.1.78.3	Yes	Yes	No
Subjective Refraction	1.2.840.10008.5.1.4.1.1.78.4	Yes	Yes	No

²⁰ EI Desktops cannot display video with MPEG-4 transfer syntaxes

²¹ Supported by XERO only as images, if video TSUID used, unsupported until 8.1.4.

SOP Class Name	SOP Class UID	Core Server / Web Server		XERO viewer & Enterprise Imaging desktops
		SCU	SCP	Display
Measurements Storage				
Visual Acuity Measurements Storage	1.2.840.10008.5.1.4.1.1.78.5	Yes	Yes	No
Spectacle Prescription Report Storage	1.2.840.10008.5.1.4.1.1.78.6	Yes	Yes	No
Ophthalmic Axial Measurements Storage	1.2.840.10008.5.1.4.1.1.78.7	Yes	Yes	No
Intraocular Lens Calculations Storage	1.2.840.10008.5.1.4.1.1.78.8	Yes	Yes	No
Macular Grid Thickness and Volume Report Storage	1.2.840.10008.5.1.4.1.1.79.1	Yes	Yes	No
Ophthalmic Visual Field Static Perimetry Measurements Storage	1.2.840.10008.5.1.4.1.1.80.1	Yes	Yes	No
Basic Text SR Storage	1.2.840.10008.5.1.4.1.1.88.11	Yes	Yes	Yes
Enhanced SR Storage	1.2.840.10008.5.1.4.1.1.88.22	Yes	Yes	Yes
Comprehensive SR Storage	1.2.840.10008.5.1.4.1.1.88.33	Yes	Yes	Yes
Procedure Log Storage	1.2.840.10008.5.1.4.1.1.88.40	Yes	No	No
Mammography CAD SR Storage	1.2.840.10008.5.1.4.1.1.88.50	Yes	Yes	Yes
Key Object Selection Document Storage	1.2.840.10008.5.1.4.1.1.88.59	Yes	Yes	Yes
Chest CAD SR Storage	1.2.840.10008.5.1.4.1.1.88.65	Yes	Yes	No
X-Ray Radiation Dose SR Storage	1.2.840.10008.5.1.4.1.1.88.67	Yes	Yes	Yes
Colon CAD SR Storage	1.2.840.10008.5.1.4.1.1.88.69	Yes	Yes	No
Implantation Plan SR Storage	1.2.840.10008.5.1.4.1.1.88.70	Yes	Yes	No
Encapsulated PDF Storage	1.2.840.10008.5.1.4.1.1.104.1	Yes	Yes	Yes
Encapsulated CDA Storage	1.2.840.10008.5.1.4.1.1.104.2	Yes	Yes	Yes ¹⁷
Positron Emission Tomography Image Storage	1.2.840.10008.5.1.4.1.1.128	Yes	Yes	Yes
Enhanced PET Image Storage	1.2.840.10008.5.1.4.1.1.130	Yes	Yes	No
Basic Structured Display Storage	1.2.840.10008.5.1.4.1.1.131	Yes	Yes	No

SOP Class Name	SOP Class UID	Core Server / Web Server		XERO viewer & Enterprise Imaging desktops
		SCU	SCP	Display
RT Image Storage	1.2.840.10008.5.1.4.1.1.481.1	Yes	Yes	Yes ²²
RT Dose Storage	1.2.840.10008.5.1.4.1.1.481.2	Yes	Yes	No
RT Structure Set Storage	1.2.840.10008.5.1.4.1.1.481.3	Yes	Yes	No
RT Beams Treatment Record Storage	1.2.840.10008.5.1.4.1.1.481.4	Yes	Yes	No
RT Plan Storage	1.2.840.10008.5.1.4.1.1.481.5	Yes	Yes	No
RT Brachy Treatment Record Storage	1.2.840.10008.5.1.4.1.1.481.6	Yes	Yes	No
RT Treatment Summary Record Storage	1.2.840.10008.5.1.4.1.1.481.7	Yes	Yes	No
RT Ion Plan Storage	1.2.840.10008.5.1.4.1.1.481.8	Yes	Yes	No
RT Ion Beams Plan Storage	1.2.840.10008.5.1.4.1.1.481.9	Yes	Yes	No
GE Private 3D Model Storage	1.2.840.113619.4.26	Yes	Yes	No
GE Private PET Raw Data Storage	1.2.840.113619.4.30	Yes	Yes	No
Dcm4che Encapsulated Document Storage	1.2.40.0.13.1.5.1.4.1.1.104.1	No	No	No
Agfa Basic Attribute Presentation State	1.2.124.113532.3500.7	No	No	No
Siemens CSA Non-Image Storage	1.3.12.2.1107.5.9.1	Yes ²³	Yes ²³	No
Philips 3D Private Presentation State Storage	1.3.46.670589.2.5.1.1	Yes	Yes	No
Philips Private MR Spectrum Storage	1.3.46.670589.11.0.0.12.1	Yes	Yes	No
Philips Private MR Series Data Storage	1.3.46.670589.11.0.0.12.2	Yes	Yes	No
Philips Private MR Examcard Data Storage	1.3.46.670589.11.0.0.12.4	Yes	Yes	No
Toshiba Aplio Ultrasound Private Storage	1.2.392.200036.9116.7.8.1.1.1	Yes	Yes	No
Hardcopy Grayscale Image Storage (Retired)	1.2.840.10008.5.1.1.29	Yes		No
Hardcopy Color Image Storage (Retired)	1.2.840.10008.5.1.1.30	Yes		No
Nuclear Medicine	1.2.840.10008.5.1.4.1.1.5	Yes	Yes	Yes

²² XERO Viewer will display if the bit depth is <=16, but not for 32 bit grayscale pixels

²³ Supported as of EI 8.1.2 SP5

SOP Class Name	SOP Class UID	Core Server / Web Server		XERO viewer & Enterprise Imaging desktops
		SCU	SCP	Display
<i>Image Storage (Retired)</i>				
<i>Ultrasound Image Storage (Retired)</i>	1.2.840.10008.5.1.4.1.1.6	Yes	Yes	Yes
<i>Ultrasound Multi-frame Image Storage (Retired)</i>	1.2.840.10008.5.1.4.1.1.3	Yes	Yes	Yes
<i>X-Ray Angiographic Bi-plane Image Storage (Retired)</i>	1.2.840.10008.5.1.4.1.1.12.3	Yes	Yes	Yes ¹⁷
<i>Standalone Overlay Storage (Retired)</i>	1.2.840.10008.5.1.4.1.1.8	Yes	Yes	No
<i>Standalone Curve Storage (Retired)</i>	1.2.840.10008.5.1.4.1.1.9	Yes	Yes	No
<i>Standalone Modality LUT Storage (Retired)</i>	1.2.840.10008.5.1.4.1.1.10	Yes	Yes	No
<i>Standalone VOI LUT Storage (Retired)</i>	1.2.840.10008.5.1.4.1.1.11	Yes	Yes	No
<i>Standalone PET Curve Storage (Retired)</i>	1.2.840.10008.5.1.4.1.1.129	Yes	Yes	No
<i>VL Image Storage (Retired)</i>	1.2.840.10008.5.1.4.1.1.77.1	Yes	Yes	Yes ¹⁷
<i>VL Multi-frame Image Storage (Retired)</i>	1.2.840.10008.5.1.4.1.1.77.2	Yes	Yes	Yes ¹⁷
Query/Retrieve				
Patient Root Query/Retrieve Information Model – FIND	1.2.840.10008.5.1.4.1.2.1.1	Yes	Yes	N/A
Patient Root Query/Retrieve Information Model – MOVE	1.2.840.10008.5.1.4.1.2.1.2	Yes	Yes	N/A
Study Root Query/Retrieve Information Model – FIND	1.2.840.10008.5.1.4.1.2.2.1	Yes	Yes	N/A
Study Root Query/Retrieve Information Model – MOVE	1.2.840.10008.5.1.4.1.2.2.2	Yes	Yes	N/A
Patient/Study Only Query/Retrieve Information Model – FIND	1.2.840.10008.5.1.4.1.2.3.1	Yes	Yes	N/A
Patient/Study Only Query/Retrieve Information Model – MOVE	1.2.840.10008.5.1.4.1.2.3.2	Yes	Yes	N/A
Workflow Management				
Storage Commitment Push Model	1.2.840.10008.1.20.1	Yes	Yes	N/A

SOP Class Name	SOP Class UID	Core Server / Web Server		XERO viewer & Enterprise Imaging desktops
		SCU	SCP	Display
Modality Worklist Information Model – Find	1.2.840.10008.5.1.4.31	No	Yes	N/A
Modality Performed Procedure Step SOP Class	1.2.840.10008.3.1.2.3.3	Yes	Yes	N/A
Instance Availability Notification	1.2.840.10008.5.1.4.33	Yes	No	
Print Management				
Basic Grayscale Print Management Meta SOP Class	1.2.840.10008.5.1.1.9	Yes	No	N/A
> Basic Film Session SOP Class	1.2.840.10008.5.1.1.1 1.2.840.10008.5.1.1.2 1.2.840.10008.5.1.1.4			
> Basic Film Box SOP Class	1.2.840.10008.5.1.1.16			
> Basic Grayscale Image Box SOP Class				
> Printer SOP Class				
Basic Color Print Management Meta SOP Class	1.2.840.10008.5.1.1.18	Yes	No	N/A
> Basic Film Session SOP Class	1.2.840.10008.5.1.1.1 1.2.840.10008.5.1.1.2 1.2.840.10008.5.1.1.4.1			
> Basic Film Box SOP Class	1.2.840.10008.5.1.1.16			
> Basic Color Image Box SOP Class				
> Printer SOP Class				
Presentation LUT SOP Class	1.2.840.10008.5.1.1.23	Yes	No	N/A

2.2.1.4 Association Establishment Policies

2.2.1.4.1 General

The Storage-SCP AE can both accept and propose Association Requests. The Storage-SCP AE will accept Association Requests for the Verification and Storage Services.

The DICOM standard application context name for DICOM 3.0 is always accepted.

Table 2-4: DICOM Application Context

Application Context Name	1.2.840.10008.3.1.1.1
---------------------------------	-----------------------

The following are the limitations on PDU size for the Enterprise Imaging AE's:

Table 2-5: Maximum PDU size

Core Server AE	Maximum PDU size	No Limits
DICOM Print AE	Maximum PDU size	65542
Web Server AE	Maximum PDU size	No Limits

2.2.1.4.2 Number of Associations

The maximum number of simultaneous associations accepted by the Enterprise Imaging AE's is provided in the table below.

Table 2-6: Number of Associations as an Association Acceptor for Storage-SCP

Core Server AE	Maximum number of simultaneous associations	512 (Configurable)
Web Server AE	Maximum number of simultaneous associations	30 (Configurable)

2.2.1.4.3 Asynchronous Nature

The Core Server AE allows a single outstanding operation on any association. Therefore, they do not support asynchronous operations window negotiation, other than the default as specified by the DICOM specification.

The Web Server AE supports asynchronous communication. Multiple outstanding transactions are supported. It allows more than one invoked and more than one performed operation on an Association. Asynchronous mode of operation is supported.

Table 2-7: Asynchronous Nature as an Association Initiator for the Enterprise Imaging AE's

Core Server AE	Maximum number of outstanding asynchronous transactions	1 (No Async)
DICOM Print AE	Maximum number of outstanding asynchronous transactions	1 (No Async)
Web Server AE	Maximum number of outstanding asynchronous transactions	1 (Configurable)

2.2.1.4.4 Implementation Identifying Information

The Enterprise Imaging AEs will respond with the implementation identifying parameters listed in the following table.

Table 2-8: DICOM implementation Class and Version for the Enterprise Imaging AE's

Core Server AE for Q/R service	Implementation Class UID	1.2.40.0.13.1.1
Core Server AE for Q/R service	Implementation Version Name	dcm4che-2.0
Core Server AE for Storage and Modality Worklist	Implementation Class UID	1.2.40.0.13.1.3
Core Server AE for Storage and Modality Worklist	Implementation Version Name for EI 8.1.1	EntImaging-8.1.1
	Implementation Version Name for EI 8.1.2	EntImaging-8.1.2
	Implementation Version Name for EI 8.1.3	EntImaging-8.1.3
	Implementation Version Name for EI 8.1.4	EntImaging-8.1.4
DICOM Print AE	Implementation Class UID	1.3.51.0.1.3
DICOM Print AE	Implementation Version Name	DPM1.00
Web Server AE	Implementation Class UID	2.25.2.0.29661496632666240 7430230612660365340
Web Server AE	Implementation Version Name	XERO Viewer 8.0.0

2.2.1.4.5 Called/Calling AE Titles

<p>Core Server AE</p>	<p>Configured at installation or initial configuration time. Multiple hosts within a single Core Server installation can use the same AE Title.</p> <p>Core Server validates the Called AE Title and the Calling AE Title specified by the requesting SCU during association negotiation. By default, Core Server will only accept associations with known Calling / Called AE Title.</p>
<p>DICOM Print AE</p>	<p>DICOM Print SCU supports a fixed (not configurable) calling AE Title (= AGFA_PACS) when exporting DICOM images to a specific hardcopy device initiated from a displayed study in the image area or from DICOM printers configuration when printing a test page.</p>
<p>Web Server AE</p>	<p>Configured at installation or initial configuration time. Multiple hosts within a single Web Server installation can use the same or different AE Titles. Host name, shortened to 16 characters is available as a called AE name, and can be automatically used for SCU calling AE name in order to direct responses to the requesting system.</p> <p>Web Server validates the Called AE Title of the requesting SCU during association negotiation. Validation of the Calling AE Title is not performed.</p>

2.2.1.5 Association Initiation Policies

2.2.1.5.1 Real World Activity – Enterprise Imaging Verification Communication-SCU

2.2.1.5.1.1 Description and Sequencing of Activity

The Enterprise Imaging Verification-SCU will issue Verification requests in response to UI mediated requests from the user to test the validity of a DICOM connection.

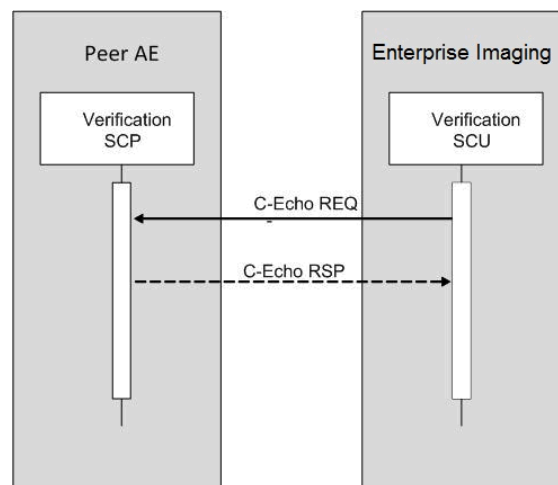

Figure 2.2-1: C-Echo Sequencing of Activity

2.2.1.5.1.2 Proposed Presentation Contexts

For the real world activity of Verification, the Enterprise Imaging Verification-SCU requests the Presentation Contexts listed in Table 2-9.

Table 2-9: Presentation Contexts Proposed by the Core Server AE

Presentation Context Table					
Abstract Syntax		Transfer Syntax		Role	Extended Negotiation
Name	UID	Name List	UID List		
Verification	1.2.840.10008.1.1	Implicit VR Little Endian	1.2.840.10008.1.2	SCU	None

2.2.1.5.1.3 SOP Specific Conformance – Verification Communication

The Enterprise Imaging Verification-SCU provides standard conformance to the DICOM Verification Service Class as an SCU.

2.2.1.5.2 Real World Activity – Enterprise Imaging Storage Commitment Request-SCU

Core Server can be configured to store and remember to VNA. As such, it is mandatory to also send a storage commit to VNA.

2.2.1.5.2.1 Description and Sequencing of Activity

Enterprise Imaging Storage Commitment Request-SCU stores images that are sent to it from an SCU. In some configurations, Enterprise Imaging may send images to another SCP, such as a PACS, for permanent storage. The request for storage commitment may then be transmitted from Enterprise Imaging together with a list of references to one or more SOP instances. This action is invoked through the DIMSE N-ACTION primitive. The following message is supported:

- **Request Storage Commitment** - to request the safekeeping of a set of SOP instances

Each Storage Commitment Request that Enterprise Imaging sends is uniquely identified by the Transaction UID Attribute (0008,1195) value that is generated by Enterprise Imaging. After sending a Storage Commitment Request, Enterprise Imaging expects an N-EVENT-REPORT from the SCP. Enterprise Imaging will then respond with an N-EVENT-REPORT response primitive with a status code.

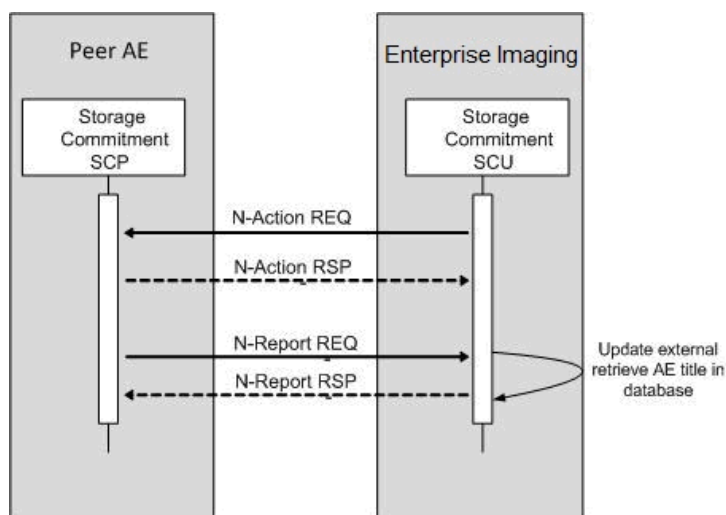

Figure 2.2-2: Send Storage Commitment Sequencing of Activity

2.2.1.5.2.2 Proposed Presentation Contexts

Enterprise Imaging may request any of the Presentation Contexts listed in Table 2-10 for Storage Commitment.

Table 2-10: Presentation Contexts Proposed by the Enterprise Imaging Storage Commitment Request-SCU

Presentation Context Table					
Abstract Syntax		Transfer Syntax		Role	Extended Negotiation
Name	UID	Name List	UID List		
Storage Commitment Push Model	1.2.840.10008.1.20.1	Implicit VR Little Endian	1.2.840.10008.1.2	SCU	None

2.2.1.5.2.3 SOP Specific Conformance – Request Storage Commitment

The Enterprise Imaging Storage Commitment Request-SCU provides conformance to the DICOM Storage Commitment Service Class as an SCU. The Action Type and Action Information specified in Table 2-11 are supported.

Table 2-11: Storage Commitment Request – Action Information

Action Type Name	Action Type ID	Attribute Name	Tag
Request Storage Commitment	1	Transaction UID	(0008,1195)
		Referenced SOP Sequence	(0008,1199)
		>Referenced SOP Class UID	(0008,1150)
		>Referenced SOP Instance UID	(0008,1155)
		Referenced Study Component Sequence	(0008,1111)
		>Referenced SOP Class UID	(0008,1150)
		>Referenced SOP Instance UID	(0008,1155)

Enterprise Imaging Storage Commitment Request-SCU will generate an N-ACTION primitive if the local configuration setting for the remote AE is enabled for storage commitment.

Enterprise Imaging Storage Commitment Request-SCU may request storage commitment for all the SOP Class UIDs listed in Table 2-3.

Enterprise Imaging Storage Commitment Request-SCU supports the Referenced Study Component Sequence Attribute.

Enterprise Imaging Storage Commitment Request-SCU will keep the Transaction ID applicable indefinitely.

Enterprise Imaging Storage Commitment Request-SCU will respond to an N-EVENT-REPORT with an N-EVENT-REPORT response primitive using one of the status codes listed in Table 2-12.

Enterprise Imaging Storage Commitment Request-SCU can configure the destination AE Title for the Storage Commit. By default, this is the AE Title where the storage request is sent.

Table 2-12: Storage Commitment Status Codes

Service Status	Further Meaning	Error Code	Description
Success	Success	0x0000	Successful notification
Failure	Processing Failure	0x0110	a general failure in processing the operation was encountered
	No such object instance	0x0112	the SOP Instance was not recognized
	No such event type	0x0113	the event type specified was not recognized
	No such argument	0x0114	the event/action information specified was not recognized/supported
	Invalid argument value	0x0115	the event/action information value specified was out of range or otherwise inappropriate
	Invalid object instance	0x0117	the SOP Instance UID specified implied a violation of the UID construction rules
	No such SOP class	0x0118	the SOP Class was not recognized
	Class instance conflict	0x0119	the specified SOP Instance is not a member of the specified SOP class
	Duplicate invocation	0x0210	the Message ID (0000,0110) specified is allocated to another notification or operation
	Unrecognized operation	0x0211	the operation is not one of those agreed between the DIMSE-service-users
Mistyped argument	0x0212	one of the parameters supplied has not been agreed for use on the Association between the DIMSE-service-users	

2.2.1.5.3 Real World Activity – Enterprise Imaging Storage-SCU

2.2.1.5.3.1 Description and Sequencing of Activity

The Enterprise Imaging Storage-SCU will transmit images to a remote Storage-SCP. An association is established when the Enterprise Imaging Storage-SCU initiates a transmit request. Enterprise Imaging Storage-SCU will establish an association automatically in response to a C-MOVE request, archive to PACS notification, or configured forwarding rules.

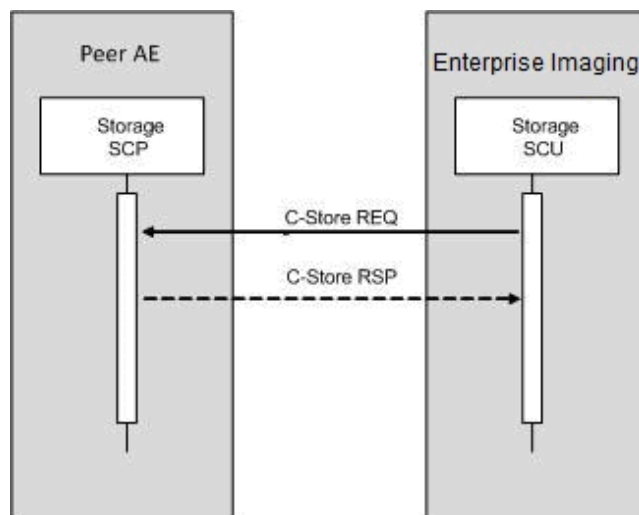

Figure 2.2-3: C-Store Sequencing of Activity

2.2.1.5.3.2 Proposed Presentation Contexts

Enterprise Imaging Storage-SCU may request any of the Presentation Contexts listed in Table 2-13 for Storage. Enterprise Imaging Storage-SCU will propose the transfer syntax used in the version of the file stored in EI and Implicit VR Little Endian. Enterprise Imaging Storage-SCU uses the first transfer syntax in accepted presentation contexts to transfer the object.

Table 2-13: Presentation Contexts Proposed by the Enterprise Imaging Storage-SCU

Presentation Context Table					
Abstract Syntax		Transfer Syntax		Role	Extended Negotiation
Name	UID	Name List	UID List		
		Little Endian Implicit VR	1.2.840.10008.1.2	SCU	None
		Little Endian Explicit VR	1.2.840.10008.1.2.1	SCU	None
		Deflated Explicit VR Little Endian	1.2.840.10008.1.2.1.99	SCU	None
		RLE Lossless, PackBits	1.2.840.10008.1.2.5	SCU	None
		JPEG Process 1, baseline, lossy (8 bit)	1.2.840.10008.1.2.4.50	SCU	None
		JPEG Process 2,4, extended lossy (12 bit)	1.2.840.10008.1.2.4.51	SCU	None
		JPEG Process 14, lossless, Non-Hierarchical	1.2.840.10008.1.2.4.57	SCU	None
		JPEG Process 14, selection value 1, lossless, Non-Hierarchical, First-Order Prediction	1.2.840.10008.1.2.4.70	SCU	None
		JPEG-LS Lossless	1.2.840.10008.1.2.4.80	SCU	None

Presentation Context Table					
Abstract Syntax		Transfer Syntax		Role	Extended Negotiation
Name	UID	Name List	UID List		
		JPEG-LS Lossy (Near-Lossless) ²⁴	1.2.840.10008.1.2.4.81	SCU	None
		JPEG 2000 Part 1 lossless (reversible) mode ²⁵	1.2.840.10008.1.2.4.90	SCU	None
		JPEG 2000 Part 1 lossy (irreversible) mode ^{24 25}	1.2.840.10008.1.2.4.91	SCU	None
		MPEG2 Main Profile @ Main Level ²⁴	1.2.840.10008.1.2.4.100	SCU	None
		MPEG2 Main Profile @ High Level ^{24 26}	1.2.840.10008.1.2.4.101	SCU	None
		MPEG-4 AVC/H.264 High Profile / Level 4.1 ^{24 26}	1.2.840.10008.1.2.4.102	SCU	None
		MPEG-4 AVC/H.264 BD compatible High Profile / Level 4.1 ^{24 26}	1.2.840.10008.1.2.4.103	SCU	None
		MPEG-4 AVC/H.264 High Profile / Level 4.2 ^{24 26}	1.2.840.10008.1.2.4.104 ²⁷	SCU	None
		MPEG-4 AVC/H.264 High Profile / Level 4.2 ^{24 26}	1.2.840.10008.1.2.4.105 ²⁷	SCU	None

2.2.1.5.3.3 SOP Specific Conformance – Store Objects

Enterprise Imaging Storage-SCU provides Standard conformance to the DICOM Storage Service Class as an SCU.

A successful C-Store response status will not generate any actions.

An unsuccessful C-Store response will cause the warning status B000: Sub-operations Complete – One or more Failures, in the final C-MOVE response to the C-MOVE request which triggers this C-Store sub-operation. The SOP Instance UID of the object, which storage to the Move Destination failed, will be listed in the Failed SOP Instance UID List (0008,0058) of the C_MOVE RSP Identifier and the value of Number of Failed Sub-operations (0000,1022) in the C-MOVE response will be incremented.

A warning status received in response to a C-Store operation will increment the value of Number of Warning Sub-operations (0000,1023) in the C-MOVE response.

2.2.1.5.4 Real World Activity – Enterprise Imaging Query/Retrieve-SCU

2.2.1.5.4.1 Real World Activity – Core Server Query Remote AE

2.2.1.5.4.1.1 Description and Sequencing of Activity

Core Server will negotiate Find requests with an SCP. Core Server can query a remote AE for composite objects to the Study Level, Series Level or Image Level. An association is

²⁴ Only if the original Video/Image is received with transfer syntax.

²⁵ Default support for these transfer syntaxes was removed as of 8.1.4. If these transfer syntaxes are required at a site, they can be added, though customers are encouraged to instead adopt the other supported transfer syntaxes, such as standard JPEG lossless.

²⁶ MPEG-4 and MPEG2 High Level Transfer Syntaxes are supported by Core Server for storage only, not display.

²⁷ Supported as of 8.1.2 SP5

established when the user initiates a query specifically for a remote AE from the graphical user interface or when there are prefetching rules configured.

Note: if an association is already open and a new find request is triggered, you may re-use the open association.

2.2.1.5.4.1.2 Proposed Presentation Contexts

Core Server will initiate any of the Presentation Contexts listed in Table 2.2-14 for Query. Core Server will initiate one or more Find Presentation Context per association request. Any single Abstract Syntax may be specified more than once in an association request, if the Transfer Syntaxes differ between the Presentation Contexts.

Table 2.2-14: Presentation Contexts Proposed by Core Server

Presentation Context Table					
Abstract Syntax		Transfer Syntax		Role	Extended Negotiation
Name	UID	Name List	UID List		
Patient Root Query/Retrieve IM Find	1.2.840.10008.5.1.4.1.2.1.1	Implicit VR Little Endian	1.2.840.10008.1.2	SCU	See Note 1
Study Root Query/Retrieve IM Find	1.2.840.10008.5.1.4.1.2.2.1	Implicit VR Little Endian	1.2.840.10008.1.2	SCU	See Note 1
Patient/Study Only Query/Retrieve IM Find	1.2.840.10008.5.1.4.1.2.3.1	Implicit VR Little Endian	1.2.840.10008.1.2	SCU	See Note 1

Note 1: C-Find Extended Negotiation will be supported. Core Server will respond with the information in Table 2.2-15.

Table 2.2-15: FIND Extended Negotiation

Field Name	Value	Description of Field
Relational-queries	1	Relational queries supported.

2.2.1.5.4.1.3 SOP Specific Conformance

Core Server provides standard conformance to the DICOM Query/Retrieve Service Class as an SCU. The Query/Retrieve Information Model used depends on the attributes used to constrain the query.

Core Server supports the Relational-queries extended SCU behavior for the Patient Root Query, Study Root Query, and Patient/Study Only Query/Retrieve.

Core Server may request any mandatory search keys during a relational query. Other search keys can be configured in the GUI.

Tables 2.2-16 to 2.2-19 describe the search keys for the four levels of query that Core Server requests.

Table 2.2-16: Patient Level Attributes

Attribute Name	Tag	VR	Matching Type ²⁸
----------------	-----	----	-----------------------------

²⁸ None keys means values requested to be returned but not with any matching value.

Attribute Name	Tag	VR	Matching Type ²⁸
Patient Name	0010,0010	PN	Single Value, Wild Card, Universal
Patient ID	0010,0020	LO	Single Value, Wild Card, Universal
Issuer of Patient ID	0010,0021	LO	None
Patient Birth Date	0010,0030	DA	Single Value, Wild Card, Universal, Range
Patient Sex	0010,0040	CS	Single Value, Wild Card, Universal
Other Patient IDs	0010,1000	LO	Sequence
Other Patient IDs Sequence	0010,1002	SQ	None
Patient Age	0010,1010	AS	None
Additional Patient History	0010,21B0	LT	None
Number of Patient Related Studies	0020,1200	IS	None
Current Patient Location	0038,0300	LO	None

Table 2.2-17: Study Level Attributes

Attribute Name	Tag	VR	Matching Type ²⁸
Study Date	0008,0020	DA	Single Value, Wild Card, Universal, Range
Study Time	0008,0030	TM	None
Accession Number	0008,0050	SH	Single Value, Wild Card, Universal
Modalities in Study	0008,0061	CS	Single Value, Wild Card, Universal
Institution Name	0008,0080	LO	None
Referring Physician Name	0008,0090	PN	Single Value, Wild Card, Universal
Timezone offset from UTC	0008,0201	SH	None
Study Description	0008,1030	LO	Single Value, Wild Card, Universal
Procedure Code Sequence	0008,1032	SQ	None
Institutional Department Name	0008,1040	LO	None
Name of Physicians Reading Study	0008,1060	PN	None
Admitting Diagnoses Description	0008,1080	LO	None
Study Instance UID	0020,000D	UI	List of UID
Study ID	0020,0010	SH	Wild Card, Universal
Number of Study Related Series	0020,1206	IS	None
Number of Study Related Images	0020,1208	IS	None
Study Status ID	0032,000A	CS	None
Requesting Physician	0032,1032	PN	None
Study Comments	0032,4000	LT	None
Confidentiality Code	0040,1008	LO	None
(All Patient Level Attributes from above)			

Table 2.2-18: Series Level Attributes

Attribute Name	Tag	VR	Matching Type ²⁸
Series Date	0008,0021	DA	None
Series Time	0008,0031	TM	None
Modality	0008,0060	CS	Single Value, Wild Card, Universal
Manufacturer	0008,0070	LO	None
Station Name	0008,1010	SH	None
Series Description	0008,103E	LO	None
Performing Physicians Name	0008,1050	PN	Single Value, Wild Card, Universal
Operators Name	0008,1070	PN	None
Manufacturer Model Name	0008,1090	LO	None
Series Instance UID	0020,000E	UI	List of UID
Series Number	0020,0011	IS	Single Value, Wild Card, Universal

Attribute Name	Tag	VR	Matching Type ²⁸
Number of Series Related Images	0020,1209	IS	None
Scheduled Procedure Step ID	0040,0009	SH	Single Value, Wild Card, Universal
Performed Procedure Step Start Date	0040,0244	DA	Single Value, Wild Card, Universal, Range
Performed Procedure Step End Date	0040,0250	DA	None
Performed Procedure Step ID	0040,0253	SH	None
Requested Procedure ID	0040,1001	SH	Single Value, Wild Card, Universal
(All Patient / Study Level Attributes from above)			

Table 2.2-19: Image Level Attributes

Attribute Name	Tag	VR	Matching Type ²⁸
Image Type	0008,0008	CS	None
SOP Class UID	0008,0016	UI	List of UID
SOP Instance UID	0008,0018	UI	List of UID
Slice Thickness	0018,0050	DS	None
Instance Number	0020,0013	IS	None
Image Orientation Patient	0020,0037	DS	None
Number of Patient Related Series	0020,1202	IS	None
Number of Patient Related Images	0020,1204	IS	None
Number of Frames	0028,0008	IS	None
Rows	0028,0010	US	None
Columns	0028,0011	US	None
Window-Center	0028,1050	DS	None
Window-Width	0028,1051	DS	None
(All Patient / Study / Series Level Attributes from above)			

Core Server automatically adds a wildcard "*" to matching keys with a VR of PN. The user is not required to add one manually.

The following matching keys are commonly available from the User Interface within Diagnostic Desktop during a relational query:

- patient_id
- patient_name
- accession_number
- referring_physician
- modalities_in_study

A user can also query using time constraints through the User Interface.

2.2.1.5.4.2 Real World Activity – Web Server Query Remote AE

2.2.1.5.4.2.1 Description and Sequencing of Activity

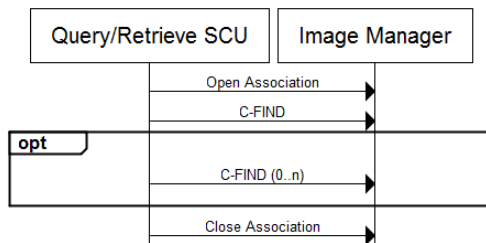

Figure 2.2-4: Query Remote AE Sequence

2.2.1.5.4.2.2 Proposed Presentation Contexts

Table 2-20: Presentation Contexts Proposed by Web Server Query/Retrieve-SCU

Presentation Context Table					
Abstract Syntax		Transfer Syntax		Role	Extended Negotiation
Name	UID	Name List	UID List		
Patient Root Query/Retrieve Information Model – FIND	1.2.840.10008.5.1.4.1.2.1.1	Implicit VR Little Endian Explicit VR Little Endian	1.2.840.10008.1.2 1.2.840.10008.1.2.1	SCU	None
Study Root Query/Retrieve Information Model – FIND	1.2.840.10008.5.1.4.1.2.2.1	Implicit VR Little Endian Explicit VR Little Endian	1.2.840.10008.1.2 1.2.840.10008.1.2.1	SCU	None
Patient/Study Only Query/Retrieve Information Model –FIND (Retired)	1.2.840.10008.5.1.4.1.2.3.1	Implicit VR Little Endian Explicit VR Little Endian	1.2.840.10008.1.2 1.2.840.10008.1.2.1	SCU	None

2.2.1.5.4.2.3 SOP Specific Conformance

The Query/Retrieve-SCU provides standard conformance to the DICOM Query Service Class as an SCU.

Web Server will use Relational-queries extended SCP behavior if available, but can be configured to use non-Relational queries as required. For displaying a study, Web Server requires Object level required return keys Rows, Columns in addition to SOP class, SOP instance UID and Instance Number. It will use other keys as available. For this purpose, it will not use the Patient Root abstract syntax.

Table 2-21: DICOM Command Response Status Handling Behavior

Service Status	Further Meaning	Error Code	Behavior
Success	Query was successful	0x0000	Results are received and processed, allowing the real-world activity to proceed.

Table 2-22: DICOM Command Communication Failure Behavior

Exception	Behavior
Timeout	The Association is aborted using A-ABORT and command marked as failed. The real-world activity is halted, and an error may be reported to the user.
Association aborted	The command is marked as failed. The real-world activity is halted, and an error may be reported to the user.

Table 2-23: Keys Used for Query / Retrieve

Level	Key	Query Type ²⁹	Displayed	Required
Patient	Patient Name	Universal Match	Yes	No
	Patient ID	Single Value (Sequence when permitted by remote PACS)	Yes	Yes
	Patient Birth Date	Single Value	Yes	Yes
	Patient Sex	Single Value	Yes	Yes
	Issuer of Patient ID	Single Value	No	No
	Other Patient ID's Sequence	Any value match	Yes	No
	Patient Age	NA	Yes	No
	Additional Patient History	NA	Yes	No
	Number Of Patient Related Studies	None	No	No
Current Patient Location	NA	Yes	No	
Study	Accession Number	Universal Match	Yes	No
	Study Instance UID	List of UID	No	Yes
	Study ID	Universal Match	No	No
	Referring Physician	Universal Match	Yes	No
	Study Date	Range	Yes	Yes
	Modalities In Study	Single Value (also Sequence)	Yes	Yes
	Study Description	None	Yes	No
	Confidentiality Code	None	Yes	No
	Study Time	None	Yes	No
	Study Status ID	None	Yes	No
	Number of Study Related Instances	None	Yes	No ³⁰
	Number of Study Related Series	None	Yes	No ³⁰
	Referring Physician Name	None	Yes	No
Requesting Physician	None	Yes	No	
Name of Physicians Reading Study	None	Yes	No	

²⁹ None keys means values requested to be returned but not with any matching value.

³⁰ When combined: Modalities in Study, Number of Study Related Instances/Series, as a set are required if structural changes to studies are to be detected.

Level	Key	Query Type ²⁹	Displayed	Required
	Admitting Diagnoses Description	None	Yes	No
	Study Comments	None	Yes	No
	Institution Name	None	Yes	No
	Institutional Department Name	None	Yes	No
	Timezone Offset from UTC	None	No	Yes
	Procedure Code Sequence	None	Yes	No
	(All Patient level attributes)			
Series	Series Number	None	Yes	No
	Series Instance UID	List of UID	No	Yes
	Modality	Single Value	Yes	Yes
	Number of Series Related Instances	None	Yes	No
	Manufacturer	None	Yes	No
	Station Name	None	Yes	No
	Performing Physician Name	None	Yes	No
	Series Date	None	Yes	No
	Series Time	None	Yes	No
	Operators Name	None	Yes	No
	Manufacturer Model Name	None	Yes	No
	Requesting Physician	None	Yes	No
	Requested Procedure ID	None	Yes	No
	Scheduled Procedure Step ID	None	Yes	No
	Performed Procedure Step Start Date	None	Yes	No
	Performed Procedure Step End Date	None	Yes	No
(All patient/study attributes from above)				
Instance	SOP Class UID	List of UID	No	Yes
	SOP Instance UID	List of UID	No	Yes
	Instance Number	None	No	Yes
	Rows	None	No	No
	Columns	None	No	No
	Pixel Spacing	None	No	No
	Window Center	None	Yes	No
	Window Width	None	Yes	No
	Number of Frames	None	No	Yes
	Image Orientation Patient	None	Yes	No
	Slice Thickness	None	Yes	No
	Image Type	None	Yes	No
	All Patient, Study, Series attributes from above			

2.2.1.5.4.3 Real World Activity – Web Server Retrieve SOP Instances

2.2.1.5.4.3.1 Description and Sequencing of Activity

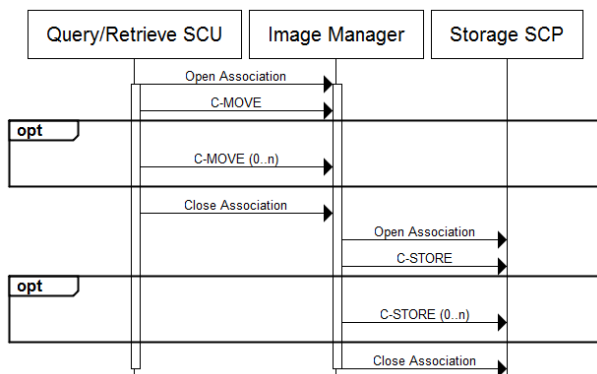

Figure 2.2-5: Retrieve SOP Instances Sequence

2.2.1.5.4.3.2 Proposed Presentation Contexts

Table 2-24: Presentation Contexts Proposed by Query/Retrieve-SCU

Presentation Context Table					
Abstract Syntax		Transfer Syntax		Role	Extended Negotiation
Name	UID	Name List	UID List		
Patient Root Query/Retrieve Information Model – MOVE	1.2.840.10008.5.1.4.1.2.1.2	Implicit VR Little Endian Explicit VR Little Endian	1.2.840.10008.1.2 1.2.840.10008.1.2.1	SCU	None
Study Root Query/Retrieve Information Model – MOVE	1.2.840.10008.5.1.4.1.2.2.2	Implicit VR Little Endian Explicit VR Little Endian	1.2.840.10008.1.2 1.2.840.10008.1.2.1	SCU	None
Patient/Study Only Query/Retrieve Information Model –MOVE (Retired)	1.2.840.10008.5.1.4.1.2.3.2	Implicit VR Little Endian Explicit VR Little Endian	1.2.840.10008.1.2 1.2.840.10008.1.2.1	SCU	None

2.2.1.5.4.3.3 SOP Specific Conformance

Table 2-25: DICOM Command Response Status Handling Behavior

Service Status	Further Meaning	Error Code	Behavior
Success	Query was successful	0x0000	Results are received and processed, allowing the real-world activity to proceed.

Table 2-26: DICOM Command Communication Failure Behavior

Exception	Behavior
Timeout	The Association is aborted using A-ABORT and command marked as failed. The real-world activity is halted, and an error may be reported to the user.
Association aborted	The command is marked as failed. The real-world activity is halted, and an error may be reported to the user.

Table 2-27: Keys Used for Retrieve

Level	Key	Query Type ³¹	Required
Study	Study Instance UID	Single Value	Yes
Series	Series Instance UID	Single Value	No
Instance	SOP Instance UID	Single Value	No

2.2.1.5.4.4 Real World Activity – Core Server Retrieve SOP Instances (SCU)

2.2.1.5.4.4.1 Description and Sequencing of Activity

Enterprise Imaging Move-SCU can retrieve composite objects from a remote AE. An association is established when the user initiates a query from the graphical user interface. Core Server will establish an association automatically to retrieve objects that were archived to the remote AE or to pre-fetch relevant objects from the remote AE based on configured prefetching rules.

2.2.1.5.4.4.2 Proposed Presentation Contexts

Core Server Move-SCU will initiate any of the Presentation Contexts listed in Table 2-28 for Move. Core Server Move-SCU will accept any number of Move Presentation Contexts per association request. Any single Abstract Syntax may be specified more than once in an association request, if the Transfer Syntaxes differ between the Presentation Contexts.

Table 2-28: Presentation Contexts Proposed by Core Server

Presentation Context Table					
Abstract Syntax		Transfer Syntax		Role	Extended Negotiation
Name	UID	Name List	UID List		
Patient Root Query/Retrieve IM Move	1.2.840.10008.5.1.4.1.2.1.2	Implicit VR Little Endian	1.2.840.10008.1.2	SCU	None
Study Root Query/Retrieve IM Move	1.2.840.10008.5.1.4.1.2.2.2	Implicit VR Little Endian	1.2.840.10008.1.2	SCU	None
Patient/Study Only Query/Retrieve IM Move	1.2.840.10008.5.1.4.1.2.3.2	Implicit VR Little Endian	1.2.840.10008.1.2	SCU	None

2.2.1.5.4.4.3 SOP Specific Conformance – Move Object

Core Server Move-SCU provides standard conformance to the DICOM Query/Retrieve Service Class as an SCU.

³¹ None keys means values requested to be returned but not with any matching value.

Core Server Move-SCU will try to establish an association with the move destination specified in the Move request. One or more of the Presentation Contexts listed in the Store section of this document may be negotiated in this association.

Table 2-29: Move Object Status Codes

Service Status	Further Meaning	Error Code	Description
Refused	SOP Class Not Supported	0122	
Refused	Not Authorized	0124	
Failure	Duplicate Invocation	0210	the Message ID (0000,0110) specified is allocated to another notification or operation
Failure	Unrecognized Operation	0211	the operation is not one of those agreed between the DIMSE-service-users

2.2.1.5.5 Real World Activity – Enterprise Imaging Modality Worklist-SCU

2.2.1.5.5.1 Real World Activity – Web Server Modality Worklist-SCU

2.2.1.5.5.1.1 Description and Sequencing of Activity

Web Server will initiate a separate association for each Find request.

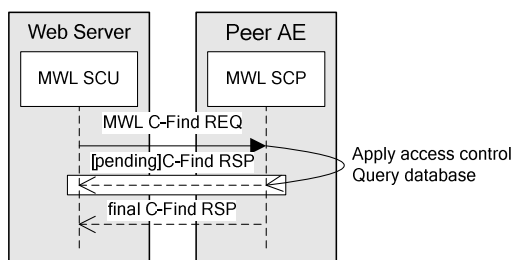

2.2.1.5.5.1.2 Proposed Presentation Contexts

Web Server will propose the Presentation Contexts listed in Table 2-30 for Find.

Table 2-30: Proposed Presentation Contexts for Web Server Modality Worklist

Presentation Context Table					
Abstract Syntax		Transfer Syntax		Role	Extended Negotiation
Name	UID	Name List	UID List		
Modality Worklist Information Model - FIND	1.2.840.10008.5.1.4.31	Implicit VR Little Endian	1.2.840.10008.1.2	SCU	Requested for Modality Worklist queries.
		Explicit VR Little Endian	1.2.840.10008.1.2.1		

2.2.1.5.5.1.3 SOP Specific Conformance

Web Server provides standard conformance to the DICOM Modality Worklist Service Class as an SCU.

Table 2-31: Keys Used by Web Server for DICOM Modality Worklist

Key	Query Type ³²	Required
Study Date	None	No
Study Time	None	No
Accession Number	Universal Match	Yes
Referring Physician Name	None	No
Patient Name	None	No
Patient Birth Date	None	No
Patient ID	Single Value or Sequence	Yes
Issuer Of Patient ID	None	No
Patient Sex	None	No
Other Patient IDs	None	No
Patient Age	None	No
Additional Patient History	None	No
Current Patient Location	None	No
Study Instance UID	UID	Yes
Requesting Physician	None	No
Requesting Service	None	No
Requested Procedure Description	None	No
Scheduled Procedure Step		
> Modality	Single Value	Yes
> Scheduled Procedure Step Start Date	Range	Yes

2.2.1.5.6 Real World Activity – Enterprise Imaging Print-SCU

2.2.1.5.6.1 Description and Sequencing of Activity

The user can print DICOM images to a specific hardcopy device from a displayed study in the image area.

A priori, a Dialog Box is displayed with print options (Printer Orientation, Film Size, Film layout and Number of copies). This Dialog Box repeats most of the print options as specified in the selected Print Preset. The user can override these options in the DICOM printing Dialog Box.

Enterprise Imaging DICOM Print AE (SCU) will initiate a separate Association for each Print Session.

After an association is established, Enterprise Imaging will send one Basic Film Session to the Printer. Each Basic Film Session will contain one or more Basic Film Boxes, which in turn refer to one or more Basic Image Boxes.

By default, Enterprise Imaging is configured to request application of a Presentation LUT (P-Values) by the Printer. In case the printer doesn't support P-Values, the parameter can be

³² None keys means values requested to be returned but not with any matching value.

unchecked and a Perception LUT can be defined in the attribute Configuration Information. Then the Presentation LUT SOP Class is not negotiated anymore.

Before instructing the Printer to print, an N-GET on Printer SOP Class is issued to obtain the current printer status information. If the Printer reports a status of FAILURE, the print-job is switched to a failed state and the Message Status in Queue Management, issues an 'Error' status.

In case the printer returns a status of NORMAL, Enterprise Imaging sends an N-ACTION on Film Box (default setting) or Film Session to instruct the Printer to print a film or a complete print job.

The film or print job is accepted by the printer when Enterprise Imaging receives a successful N-ACTION response.

The default PDU size negotiated by Enterprise Imaging is 65542 bytes.

Enterprise Imaging applies a pixel depth rule in order to convert the original image to 8 or 12bit for printing (see chapter 2.2.1.5.6.3.3). Additionally images may be converted to or from RGB 8 bit/pixel depending on printer capabilities.

The pixel data may optionally include burned in demographics and/or markup in the image area.

The WADO service is used to generate printable DICOM objects.

Multiframe objects are converted to single frames for printing, one object per frame.

Figure 2.2-6 illustrates the sequencing of activity when Enterprise Imaging initiates print requests to a Print-SCP.

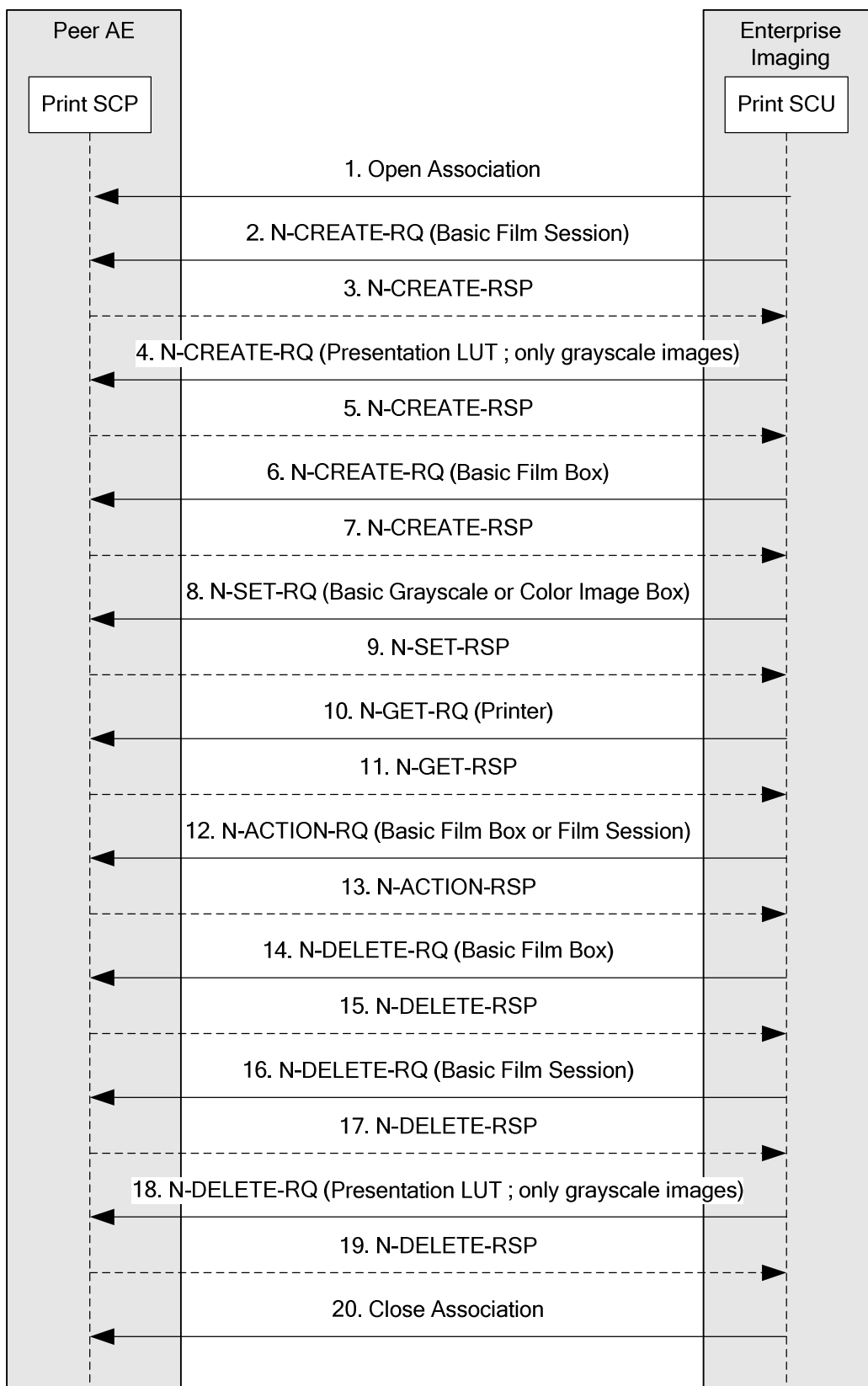

Figure 2.2-6: Print Sequencing of Activity

2.2.1.5.6.2 Proposed Presentation Context

Enterprise Imaging Print SCU is capable of proposing the Presentation Contexts shown in the table below:

Table 2.2-32: Proposed Presentation Contexts for Activity Print

Presentation Context Table					
Abstract Syntax		Transfer Syntax		Role	Ext. Neg.
Name	UID	Name List	UID List		
Basic Grayscale Print Management Meta	1.2.840.10008.5.1.1.9	Implicit VR Little Endian	1.2.840.10008.1.2	SCU	None
Basic Color Print Management Meta	1.2.840.10008.5.1.1.18	Implicit VR Little Endian	1.2.840.10008.1.2	SCU	None
Presentation LUT	1.2.840.10008.5.1.1.23	Implicit VR Little Endian	1.2.840.10008.1.2	SCU	None

2.2.1.5.6.3 SOP Specific Conformance – Basic Grayscale Print Management Meta SOP Class

Enterprise Imaging Print SCU supports the following mandatory SOP classes as defined by the Basic Grayscale Print Management Meta SOP Class (1.2.840.10008.1.1.9):

Table 2.2-33: SOP Classes for Basic Grayscale Print Management Meta SOP Class

SOP Class Name	SOP Class UID	Role
Basic Film Session	1.2.840.10008.5.1.1.1	SCU
Basic Film Box	1.2.840.10008.5.1.1.2	SCU
Basic Grayscale Image Box	1.2.840.10008.5.1.1.4	SCU
Printer	1.2.840.10008.5.1.1.16	SCU

2.2.1.5.6.3.1 Basic Film Session SOP Class

The Basic Film Session IOD describes the presentation parameters which are common for all the films of a film session. The Basic Film Session SOP Instance refers to one or more Basic Film Box SOP Instances (see chapter 2.2.1.5.6.3.2).

Enterprise Imaging Print SCU provides support for the following DIMSE services:

- N-CREATE
- N-ACTION
- N-DELETE

N-CREATE is used to create a Basic Film Session SOP Instance, when an association has been established. The N-CREATE causes the Basic Film Session (root element) to be created and its attributes initialized. The values are available in an xml-file that describes the technical capabilities of the printer and configured in a Print Preset. Furthermore, the user can make some final choices in an Export Dialog Box.

The following attributes are supported:

Table 2.2-34: Supported N-CREATE Attributes for Basic Film Session

Attribute Name	Tag	Value and comments
Number of Copies	(2000,0010)	1 (configurable)
Print Priority	(2000,0020)	LOW
Medium Type	(2000,0030)	BLUE FILM, CLEAR FILM, MAMMO BLUE FILM, MAMMO CLEAR FILM, PAPER (configurable)
Film Destination	(2000,0040)	PROCESSOR

Enterprise Imaging Print SCU will process the N-CREATE response. The following status codes are recognized:

Table 2.2-35: N-CREATE response Status Codes

Service Status	Further Meaning	Error Code	Reason
Success	Success	0x0000	The SCP has completed the operation successfully.
Failure	No Such Attribute	0x0105	the Tag for the specified Attribute was not recognized
Failure	Invalid Attribute Value	0x0106	the Attribute Value specified was out of range or otherwise inappropriate
Warning	Attribute List Error	0x0107	one or more Attribute Values were not read/modified/created because the specified Attribute was not recognized
Failure	Processing Failure	0x0110	a general failure in processing the operation was encountered
Failure	Duplicate SOP Instance	0x0111	the new managed SOP Instance Value supplied by the invoking DIMSE-service-user was already registered for a managed SOP Instance of the specified SOP Class
Warning	Attribute Value Out Of Range	0x0116	the Attribute Value specified was out of range or otherwise inappropriate
Failure	Invalid Object Instance	0x0117	the SOP Instance UID specified implied a violation of the UID construction rules
Failure	No Such SOP class	0x0118	the SOP Class was not recognized
Failure	Missing Attribute	0x0120	a required Attribute was not supplied
Failure	Missing Attribute Value	0x0121	a required Attribute Value was not supplied and a default value was not available
Refused	Not Authorized	0x0124	
Failure	Duplicate Invocation	0x0210	the Message ID (0000,0110) specified is allocated to another notification or operation
Failure	Unrecognized Operation	0x0211	the operation is not one of those agreed between the DIMSE-service-users
Failure	Mistyped Argument	0x0212	one of the parameters supplied has not been agreed for use on the Association between the DIMSE-service-users
*	*	Any other status code	The Association is aborted using A-ABORT and the sent job is marked as failed. The status code is logged.

N-ACTION will result in submitting a print job to print all the films of the film session in the order that they were received. This means that all subordinate Basic Film Boxes will be assembled into a print job for printing. Therefore, the job can contain more than one film.

Enterprise Imaging Print SCU will process the N-ACTION response. The following status codes are recognized:

Table 2.2-36: N-ACTION response Status Codes

Service Status	Further Meaning	Error Code	Reason
Success	Success	0x0000	The SCP has completed the operation successfully.
Failure	Processing Failure	0x0110	a general failure in processing the operation was encountered
Failure	No Such Object Instance	0x0112	the SOP Instance was not recognized
Failure	No Such Argument	0x0114	the event/action information specified was not recognized/supported
Failure	Invalid Argument Value	0x0115	the event/action information value specified was out of range or otherwise inappropriate
Failure	Invalid Object Instance	0x0117	the SOP Instance UID specified implied a violation of the UID construction rules
Failure	No Such SOP class	0x0118	the SOP Class was not recognized
Failure	Class Instance Conflict	0x0119	the specified SOP Instance is not a member of the specified SOP class
Failure	No Such Action Type	0x0123	the action type specified was not supported
Refused	Not Authorized	0x0124	
Failure	Duplicate Invocation	0x0210	the Message ID (0000,0110) specified is allocated to another notification or operation
Failure	Unrecognized Operation	0x0211	the operation is not one of those agreed between the DIMSE-service-users
Failure	Mistyped Argument	0x0212	one of the parameters supplied has not been agreed for use on the Association between the DIMSE-service-users
*	*	Any other status code	The Association is aborted using A-ABORT and the sent job is marked as failed. The status code is logged.

N-DELETE is used to delete a Film Session. This means that the complete Film Session SOP Instance hierarchy will be deleted.

Enterprise Imaging Print SCU will process the N-DELETE response. The following status codes are recognized:

Table 2.2-37: N-DELETE response Status Codes

Service Status	Further Meaning	Error Code	Reason
Success	Success	0x0000	The SCP has completed the operation successfully.
Failure	Processing Failure	0x0110	a general failure in processing the operation was encountered
Failure	No Such Object Instance	0x0112	the SOP Instance was not recognized
Failure	Invalid Object Instance	0x0117	the SOP Instance UID specified implied a violation of the UID construction rules
Failure	No Such SOP class	0x0118	the SOP Class was not recognized
Failure	Class Instance Conflict	0x0119	the specified SOP Instance is not a member of the specified SOP class
Refused	Not Authorized	0x0124	
Failure	Duplicate Invocation	0x0210	the Message ID (0000,0110) specified is allocated to another notification or operation

Service Status	Further Meaning	Error Code	Reason
Failure	Unrecognized Operation	0x0211	the operation is not one of those agreed between the DIMSE-service-users
Failure	Mistyped Argument	0x0212	one of the parameters supplied has not been agreed for use on the Association between the DIMSE-service-users
*	*	Any other status code	The Association is aborted using A-ABORT and the sent job is marked as failed. The status code is logged.

2.2.1.5.6.3.2 Basic Film Box SOP Class

The Basic Film Box IOD is an abstraction of the presentation of one film of the film session. It also describes the presentation parameters which are common for all images on a given sheet of film.

The Basic Film Box SOP instance refers to one or more Image Box SOP Instances (see chapters 0 and 2.2.1.5.6.4.3) and zero or one Presentation LUT SOP Instance (see chapter 2.2.1.5.6.5).

Enterprise Imaging Print SCU provides support for the following DIMSE services:

- N-CREATE
- N-ACTION
- N-DELETE

N-CREATE is used to create a Basic Film Box SOP Instance under the created Film Session and initialize its attributes. The values are available in an xml-file that describes the technical capabilities of the printer and configured in a Print Preset. Furthermore, the user can make some final choices in an Export Dialog Box.

The creation of a Basic Film Box also causes the subordinate Image Boxes to be created for each location in the Image Display Format.

The following attributes are supported:

Table 2.2-38: Supported N-CREATE Attributes for Basic Film Box

Attribute Name	Tag	Value and comments
Image Display Format	(2010,0010)	STANDARD\C,R, ROW\R1,R2,R3, etc., COL\R1,R2,R3, etc., SLIDE and SUPERSLIDE. (configurable)
Film Orientation	(2010,0040)	PORTRAIT and LANDSCAPE (configurable)
Film Size ID	(2010,0050)	configurable
Magnification Type	(2010,0060)	REPLICATE, BILINEAR, CUBIC and NONE (configurable)
Smoothing Type	(2010,0080)	Further specifies the type of the interpolation function. Only valid for Magnification Type (2010,0060) = CUBIC. (configurable) <u>Values supported by Agfa DICOM printers:</u> 0 (= cubicB) 100 ... 199 (cubicHighRes) 200...299 (cubicBell)
Border Density	(2010,0100)	BLACK, WHITE or i, where i represents the desired density in hundreds of OD (configurable)
Empty Image Density	(2010,0110)	BLACK, WHITE or i, where i represents the desired density in hundreds of OD (configurable)

Attribute Name	Tag	Value and comments
Min Density	(2010,0120)	Minimum density of the images on the film, expressed in hundredths of OD (configurable)
Max Density	(2010,0130)	Maximum density of the images on the film, expressed in hundredths of OD (configurable).
Trim	(2010,0140)	YES, NO (configurable)
Configuration Information	(2010,0150)	Will be populated with a set of values for implementation specific print parameters, e.g. perception LUT related parameters. See DICOM Conformance Statement of the printer. Perception LUT's for Agfa Printers: PERCEPTION_LUT={LINEAR, KANAMORI, n, OEMxxx} Where n = 75 to 220 Note that Presentation LUT has priority when enabled. (configurable)
Illumination	(2010,015E)	Expressed as L ₀ , in candelas per square meter (cd/m ²). Needs to be configured when Presentation LUT is enabled.
Reflected Ambient Light	(2010,0160)	Expressed as L ₀ , in candelas per square meter (cd/m ²). Needs to be configured when Presentation LUT is enabled.
Referenced Film Session Sequence	(2010,0500)	A sequence which provides references to a Film Session SOP Class/Instance pairs. Only a single Item shall be permitted in this Sequence.
>Referenced SOP Class UID	(0008,1150)	Uniquely identifies the referenced SOP Class.
>Referenced SOP Instance UID	(0008,1155)	Uniquely identifies the referenced SOP Instance.
Referenced Presentation LUT Sequence	(2050,0500)	A sequence which provides references to a Presentation LUT related SOP Class/Instance pairs. Only a single Item shall be included in this sequence.
>Referenced SOP Class UID	(0008,1150)	Uniquely identifies the referenced SOP Class.
>Referenced SOP Instance UID	(0008,1155)	Uniquely identifies the referenced SOP Instance.

Enterprise Imaging Print SCU will process the N-CREATE response. The recognized status codes are described in Table 2.2-35: N-CREATE response Status Codes.

N-ACTION will result in submitting the print job for printing the specific Film Box (or film).

Enterprise Imaging Print SCU will process the N-ACTION response. The recognized status codes are described in Table 2.2-36: N-ACTION response Status Codes.

N-DELETE is used to delete a Film Box. This means that the complete Film Box SOP Instance hierarchy will be deleted.

Enterprise Imaging Print SCU will process the N-DELETE response. The recognized status codes are described in Table 2.2-37: N-DELETE response Status Codes.

2.2.1.5.6.3.3 Basic Grayscale Image Box SOP class

The Basic Image Box IOD is an abstraction of the presentation of an image and image related data in the image area of the film. The Basic Image Box IOD describes the presentation parameters and image pixel data which apply to a single image of a sheet film.

The Basic Grayscale Image Box SOP instance is created by the Printer at the time the N-CREATE of the Basic Film Box (see chapter 2.2.1.5.6.3.2) is processed, based on the value of the Basic Film Box attribute Image Display Format (2010,0010).

Enterprise Imaging Print SCU provides support for the following DIMSE service:

- N-SET

N-SET

The command is issued by Enterprise Imaging Print SCU to update an instance of the Grayscale Image Box SOP Class. For each image in the Basic Film Box, the attributes of the Basic Image Box are set. The values are available in an xml-file that describes the technical capabilities of the printer and configured in a Print Preset.

The following attributes are supported:

Table 2.2-39: Supported N-SET Attributes for Basic Grayscale Image Box

Attribute Name	Tag	Value and comments
Image Position	(2020,0010)	The position of the image on the film, based on Image Display Format (2010,0010).
Polarity	(2020,0020)	NORMAL and REVERSE (configurable)
Requested Image Size	(2020,0030)	Sent when True Size printing is configured. Width (x-dimension) in mm of the image to be printed. Calculated from attribute values Imager Pixel Spacing (0018,1164) & Columns (0028,0011)
Requested Decimate/Crop Behavior	(2020,0040)	CROP
Basic Grayscale Image Sequence	(2020,0110)	
> Samples Per Pixel	(0028,0002)	1
> Photometric Interpretation	(0028,0004)	MONOCHROME2
> Rows	(0028,0010)	Original number of pixels of the image height
> Columns	(0028,0011)	Original number of pixels of the image width
> Pixel Aspect Ratio	(0028,0034)	1/1
> Bits Allocated	(0028,0100)	8 (if Bits Stored = 8) 16 (if Bits Stored = 12)
> Bits Stored	(0028,0101)	8 or 12
> High Bit	(0028,0102)	7 (if BITS STORED = 8) 11 (if BITS STORED = 12)
> Pixel Representation	(0028,0103)	0
> Pixel Data	(7FE0,0010)	Data representation of pixel samples that comprise the image

For Enterprise Imaging to decide what pixel depth to convert the source image to, the following table applies:

Grayscale Image	Printer	Source	Target
-----------------	---------	--------	--------

	supports pixeldepth 12	pixeldepth	pixeldepth
Grayscale	no	any	8
	yes	8-11	8
		12-16	12

Enterprise Imaging Print SCU will process the N-SET response. The following status codes are recognized:

Table 2.2-40: N-SET response Status Codes

Service Status	Further Meaning	Error Code	Reason
Success	Success	0x0000	The SCP has completed the operation successfully.
Failure	No Such Attribute	0x0105	the Tag for the specified Attribute was not recognized
Failure	Invalid Attribute Value	0x0106	the Attribute Value specified was out of range or otherwise inappropriate
Warning	Attribute List Error	0x0107	one or more Attribute Values were not read/modified/created because the specified Attribute was not recognized
Failure	Processing Failure	0x0110	a general failure in processing the operation was encountered
Failure	No Such Object Instance	0x0112	the SOP Instance was not recognized
Warning	Attribute Value Out Of Range	0x0116	the Attribute Value specified was out of range or otherwise inappropriate
Failure	Invalid Object Instance	0x0117	the SOP Instance UID specified implied a violation of the UID construction rules
Failure	No Such SOP class	0x0118	the SOP Class was not recognized
Failure	Class Instance Conflict	0x0119	the specified SOP Instance is not a member of the specified SOP class
Failure	Missing Attribute Value	0x0121	a required Attribute Value was not supplied and a default value was not available
Refused	Not Authorized	0x0124	
Failure	Duplicate Invocation	0x0210	the Message ID (0000,0110) specified is allocated to another notification or operation
Failure	Unrecognized Operation	0x0211	the operation is not one of those agreed between the DIMSE-service-users
Failure	Mistyped Argument	0x0212	one of the parameters supplied has not been agreed for use on the Association between the DIMSE-service-users
Failure	Resource Limitation	0x0213	the operation was not performed due to resource limitation
*	*	Any other status code	The Association is aborted using A-ABORT and the sent job is marked as failed. The status code is logged.

2.2.1.5.6.3.4 Printer SOP Class

The Printer IOD is an abstraction of the hard copy printer and is the basic Information Entity to monitor the status of the printer. The Printer SOP Instance is created by the Printer during start-up of the hard copy printer and has a well-known SOP Instance UID.

Core Server Print SCU provides support for the following DIMSE service:

- N-GET

N-GET is used to retrieve an instance of the Printer SOP Class.

Enterprise Imaging Print SCU issues the command to obtain information about the current

printer status. If the Printer reports a status of FAILURE, the print-job is switched to a failed state and the user informed.

The attributes obtained via N-GET are listed in the Table below:

Table 2.2-41: N-GET attributes on a Printer

Attribute Name	Tag	Value
Printer Status	(2110,0010)	NORMAL, WARNING, FAILURE
Printer Status Info	(2110,0020)	Printer dependent
Printer Name	(2110,0030)	User defined name identifying the printer
Manufacturer	(0008,0070)	Manufacturer of the printer
Manufacturer Model Name	(0008,1090)	Manufacturer's model number of the printer
Device Serial Number	(0018,1000)	Manufacturer's serial number of the printer
Software Versions	(0018,1020)	Manufacturer's designation of software version of the printer
Date Last Calibration	(0018,1200)	Date when the printer was last calibrated
Last Calibration	(0018,1201)	Time when the printer was last calibrated

2.2.1.5.6.4 SOP Specific Conformance – Basic Color Print Management Meta SOP class

Enterprise Imaging Print SCU supports the following mandatory SOP classes as defined by the Basic Color Print Management Meta SOP Class (1.2.840.10008.1.1.18):

Table 2.2-42: SOP Classes for Basic Color Print Management Meta SOP Class

SOP Class Name	SOP Class UID	Role
Basic Film Session	1.2.840.10008.5.1.1.1	SCU
Basic Film Box	1.2.840.10008.5.1.1.2	SCU
Basic Color Image Box	1.2.840.10008.5.1.1.4.1	SCU
Printer	1.2.840.10008.5.1.1.16	SCU

2.2.1.5.6.4.1 Basic Film Session SOP Class

Refer to 'Basic Film Session SOP Class' for 'Basic Grayscale Print Management Meta SOP Class' (chapter 2.2.1.5.6.3.1).

2.2.1.5.6.4.2 Basic Film Box SOP Class

Refer to 'Basic Film Box SOP Class' for 'Basic Grayscale Print Management Meta SOP Class' (chapter 2.2.1.5.6.3.2).

2.2.1.5.6.4.3 Basic Color Image Box SOP Class

The Basic Image Box IOD is an abstraction of the presentation of an image and image related data in the image area of the film. The Basic Image Box IOD describes the presentation parameters and image pixel data which apply to a single image of a sheet film.

The Basic Color Image Box SOP instance is created by the Printer at the time the N-CREATE of the Basic Film Box (see chapter 2.2.1.5.6.4.2) is processed, based on the value of the Basic Film Box attribute Image Display Format (2010,0010).

Enterprise Imaging Print SCU provides support for the following DIMSE service:

➤ N-SET

N-SET

The command is issued by Enterprise Imaging Print SCU to update an instance of the Color Image Box SOP Class. For each image in the Basic Film Box, the attributes of the Basic Image Box are set. The values are available in an xml-file that describes the technical capabilities of the printer and configured in a Print Preset.

The following attributes are supported:

Table 2.2-43: Supported N-SET Attributes for Basic Color Image Box

Attribute Name	Tag	Value and comments
Image Position	(2020,0010)	The position of the image on the film, based on Image Display Format (2010,0010).
Requested Image Size	(2020,0030)	Sent when True Size printing is configured. Width (x-dimension) in mm of the image to be printed. Calculated from attribute values Imager Pixel Spacing (0018,1164) & Columns (0028,0011)
Basic Color Image Sequence	(2020,0111)	
> Samples Per Pixel	(0028,0002)	1
>Photometric Interpretation	(0028,0004)	RGB
>Planar Configuration	(0028,0006)	1 (frame interleave)
>Rows	(0028,0010)	Original number of pixels of the image in the height
>Columns	(0028,0011)	Original number of pixels of the image in the width
>Pixel Aspect Ratio	(0028,0034)	1/1
>Bits Allocated	(0028,0100)	8
>Bits Stored	(0028,0101)	8
>High Bit	(0028,0102)	7
>Pixel Representation	(0028,0103)	0
>Pixel Data	(7FE0,0010)	Data representation of pixel samples that comprise the image

Enterprise Imaging Print SCU will process the N-SET response. The N-SET response status codes are described in Table 2.2-40: N-SET response Status Codes.

2.2.1.5.6.4.4 Printer SOP Class

Refer to 'Printer SOP Class' for 'Basic Grayscale Print Management Meta SOP Class' (chapter 2.2.1.5.6.3.4).

2.2.1.5.6.5 SOP Specific Conformance – Presentation LUT SOP Class

The Presentation LUT Information Object is an abstraction of a Presentation LUT.

The Basic Film Box Information Object references the Presentation LUT (see chapter 2.2.1.5.6.3.2).

If the Configuration Information Attribute (2010,0150) of the Basic Film Box IOD contains information similar to the Presentation LUT, then the Presentation LUT Attributes shall take precedence.

The output of the Presentation LUT is Presentation Values (P-Values). P-Values are approximately related to human perceptual response. They are intended to facilitate common input for both hardcopy and softcopy display devices.

The Presentation LUT is not intended to alter the appearance of the pixel values, as specified by the Photometric Interpretation (0028,0004) and Polarity (2020,0020).

The Printer shall use the Grayscale Standard Display Function as specified in PS 3.14 to convert the output of the Presentation LUT to density for printing. Enterprise Imaging Print SCU specifies values for Illumination (2010,015E) and/or Reflected Ambient Light (2010,0160). The Printer applies the GSDF curve together with the density range to be printed, Min Density to Max Density, as is specified at Film Box level.

Core Server Print SCU provides support for the following DIMSE service:

- N-CREATE
- N-DELETE

N-CREATE is issued by Enterprise Imaging Print SCU to create a Presentation LUT SOP Instance.

The following attributes are supported:

Table 2.2-44: Supported N-CREATE Attribute for Presentation LUT

Attribute Name	Tag	Value and comments
Presentation LUT Shape	(2050,0020)	IDENTITY

Enterprise Imaging Print SCU will process the N-CREATE response. The N-CREATE response status codes are described in Table 2.2-35: N-CREATE response Status Codes.

N-DELETE is used to delete the Presentation LUT SOP Instance.

Enterprise Imaging Print SCU will process the N-DELETE response. The N-DELETE response status codes are described in Table 2.2-37: N-DELETE response Status Codes.

2.2.1.6 Association Acceptance Policies

The Enterprise Imaging AE's accept associations for the following real-world activities:

- Verification Communication
- Request Storage Commitment
- Store Objects
- Find Object
- Move Object
- Modality Performed Procedure Step
- Modality Worklist

Association requests from unknown Application Entities will be rejected by the Enterprise Imaging AE's.

2.2.1.6.1 Real World Activity – Verification Communication-SCP

2.2.1.6.1.1 Description and Sequencing of Activity

The Enterprise Imaging Verification-SCP will respond to Verification requests to provide an SCU with the ability to determine if the Enterprise Imaging Verification-SCP is receiving DICOM requests.

2.2.1.6.1.2 Accepted Presentation Contexts

The Enterprise Imaging Verification-SCP will accept any of the Presentation Contexts listed in Table 2-45 for Verification.

Table 2-45: Presentation Contexts Proposed by the Enterprise Imaging Verification-SCP

Presentation Context Table					
Abstract Syntax		Transfer Syntax		Role	Extended Negotiation
Name	UID	Name List	UID List		
Verification	1.2.840.10008.1.1	Implicit VR Little Endian	1.2.840.10008.1.2	SCP	None

2.2.1.6.1.3 SOP Specific Conformance - Verification Communication

The Enterprise Imaging Verification-SCP provides standard conformance to the DICOM Verification Service Class as an SCU. The Enterprise Imaging Verification-SCP returns one of the following status codes.

Table 2-46: Verification Response Status

Service Status	Further Meaning	Error Code	Reason
Success	Success	0x0000	Operation performed properly.
Failure	Duplicate Invocation	0x0210	the Message ID (0000,0110) specified is allocated to another notification or operation
Failure	Unrecognized Operation	0x0211	the operation is not one of those agreed between the DIMSE-service-users

2.2.1.6.1.4 Presentation Context Acceptance Criterion – Verification Communication

The Enterprise Imaging Verification-SCP will always accept a Presentation Context for the Verification SOP Class with the default DICOM transfer syntax listed in Table 2-45.

2.2.1.6.1.5 Transfer Syntax Selection Policies - Verification Communication

Since no DICOM data object is associated with a Verification command, only the default DICOM transfer syntax is required/supported.

2.2.1.6.2 Real World Activity – Enterprise Imaging Storage Commitment-SCP

2.2.1.6.2.1 Description and Sequencing of Activity

Enterprise Imaging stores images that are sent to it from a Storage SCU. The request for storage commitment may then be transmitted to the Enterprise Imaging Storage Commitment-SCP together with a list of references to one or more SOP instances. Enterprise Imaging Storage Commitment-SCP will receive and respond to DIMSE N-ACTION. The following message is supported:

- **Request Storage Commitment** - to request the safekeeping of a set of SOP instances

When Enterprise Imaging Storage Commitment-SCP is ready to commit successful recipient of the requested objects, an Association Request is sent to the peer AE that sent the Storage Commitment Push Model request. Upon successful negotiation of the required Presentation Context the outstanding N-EVENT-REPORT is sent.

Figure 2.2-7 illustrates the sequencing of activities when Enterprise Imaging Storage Commitment-SCP receives a storage commitment request (N-Action) and send a storage commitment response (N-Event).

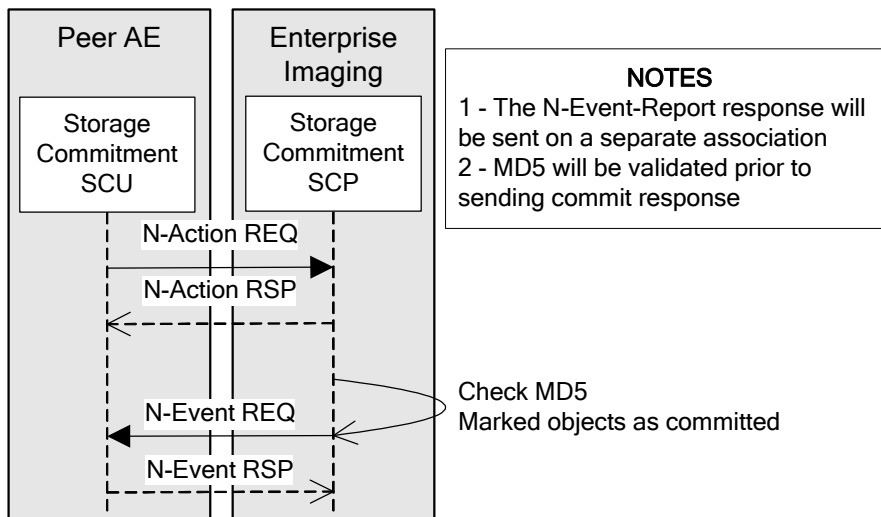

Figure 2.2-7: Storage Commitment Request Sequencing of Activity

2.2.1.6.2.2 Accepted Presentation Contexts

Enterprise Imaging Storage Commitment-SCP will accept any of the Presentation Contexts listed in Table 2-47 for Storage Commitment.

Table 2-47: Presentation Contexts Accepted for Storage Commitment Request Sent by Remote AE

Presentation Context Table					
Abstract Syntax		Transfer Syntax		Role	Extended Negotiation
Name	UID	Name List	UID List		
Storage Commitment Push Model	1.2.840.10008.1.20.1	Implicit VR Little Endian	1.2.840.10008.1.2	SCP	None
		Explicit VR Little Endian	1.2.840.10008.1.2.1		

2.2.1.6.2.3 SOP Specific Conformance

Enterprise Imaging Storage Commitment-SCP provides standard conformance to the DICOM **Storage Commitment Service Class** as an SCP. Enterprise Imaging Storage Commitment-SCP supports the elements listed in Table 2-48 for this SOP class.

The associated Activity with the Storage Commitment Push Model service is the communication by the Storage Commitment AE to peer AEs that it has committed to permanently store Composite SOP Instances that have been sent to it.

It thus allows peer AEs to determine whether the Storage-SCP AE has taken responsibility for the archiving of specific SOP Instances so that they can be flushed from the peer AE system.

The Storage Commitment SCP AE will initiate a new Association to a peer AE that sent a Storage Commitment Push Model request if the original Association over which this was sent is no longer open.

Table 2-48: Storage Commitment Request – Action Information

Action Type Name	Action Type ID	Attribute Name	Tag
Request Storage Commitment	1	Transaction UID	(0008,1195)
		Referenced SOP Sequence	(0008,1199)
		>Referenced SOP Class UID	(0008,1150)
		>Referenced SOP Instance UID	(0008,1155)

Enterprise Imaging Storage Commitment-SCP will store SOP Instances indefinitely unless the instances are manually deleted by a user with appropriate system permissions. The capacity is limited only by the availability of archive storage and volatility is dependent on the archive medium used. Enterprise Imaging Storage Commitment-SCP will stop accepting new objects for storage to ensure the availability of objects for which a successful storage commitment response has been sent.

2.2.1.6.2.4 Storage Commitment Result

If Enterprise Imaging Storage Commitment-SCP determines that it has successfully completed storage commitment, Enterprise Imaging Storage Commitment-SCP issues an N-EVENT-REPORT to the SCU including references to the successfully stored SOP Instances contained in the N-ACTION.

In the event that Enterprise Imaging Storage Commitment-SCP cannot commit to storing SOP Instances, Enterprise Imaging Storage Commitment-SCP issues an N-EVENT-REPORT to the SCU including references to the failed SOP Instances contained in the N-ACTION.

The N-EVENT-REPORT contains the Transaction UID value contained in the initiating N-ACTION. The N-EVENT-REPORT is sent on a separate association from the N-ACTION operation.

Enterprise Imaging Storage Commitment-SCP supports the Event Information as specified in Table 2-49. Core Server supports the optional Retrieve AE Title (0008,0054) Attributes in the N-EVENT-REPORT.

Table 2-49: Storage Commitment Result – Event Information

Action Type Name	Event Type ID	Attribute Name	Tag
Storage Commitment Request Successful	1	Transaction UID	(0008,1195)
		Referenced SOP Sequence	(0008,1199)
		>Referenced SOP Class UID	(0008,1150)
		>Referenced SOP Instance UID	(0008,1155)
		>Retrieve AE Title	(0008,0054)
Storage Commitment Request Complete-Failures Exist	2	Transaction UID	(0008,1195)
		Referenced SOP Sequence	(0008,1199)
		>Referenced SOP Class UID	(0008,1150)
		>Referenced SOP Instance UID	(0008,1155)
		>Retrieve AE Title	(0008,0054)
		Failed SOP Sequence	(0008,1198)
		>Referenced SOP Class UID	(0008,1150)
		>Referenced SOP Instance UID	(0008,1155)
>Failure Reason	(0008,1197)		

Table 2.2-50: N-EVENT-REPORT response Status Codes

Service Status	Further Meaning	Error Code	Reason
Success	Success	0x0000	The SCP has completed the operation successfully.
Failure	Processing Failure	0x0110	a general failure in processing the operation was encountered
Failure	No Such Object Instance	0x0112	the SOP Instance was not recognized
Failure	No Such Event Type	0x0113	the event type specified was not recognized
Failure	No Such Argument	0x0114	the event/action information specified was not recognized/supported
Failure	Invalid Argument Value	0x0115	the event/action information value specified was out of range or otherwise inappropriate
Failure	Invalid Object Instance	0x0117	the SOP Instance UID specified implied a violation of the UID construction rules
Failure	No Such SOP class	0x0118	the SOP Class was not recognized
Failure	Class Instance Conflict	0x0119	the specified SOP Instance is not a member of the specified SOP class
Failure	Duplicate Invocation	0x0210	the Message ID (0000,0110) specified is allocated to another notification or operation
Failure	Unrecognized Operation	0x0211	the operation is not one of those agreed between the DIMSE-service-users
Failure	Mistyped Argument	0x0212	one of the parameters supplied has not been agreed for use on the Association between the DIMSE-service-users

2.2.1.6.2.5 Operations – Storage Commitment

Enterprise Imaging Storage Commitment-SCP will never delete SOP Instances for which Storage Commitment was requested – except deletion is forced manually by authorized user.

SOP Instances can be retrieved from Enterprise Imaging Storage Commitment-SCP using C-FIND and C-MOVE.

2.2.1.6.2.6 Presentation Context Acceptance Criterion

Enterprise Imaging Storage Commitment-SCP will accept any number of Storage Presentation Contexts per association request. Any one Abstract Syntax may be specified more than once in an association request, if the Transfer Syntaxes differ between the Presentation Contexts.

2.2.1.6.2.7 Transfer Syntax Selection Policies

Explicit VR Little Endian is preferred over Implicit VR Little Endian.

2.2.1.6.3 Real World Activity – Enterprise Imaging Storage-SCP

2.2.1.6.3.1 Description and Sequencing of Activity

Enterprise Imaging will store images that are sent to it from a Storage SCU. All images received by Enterprise Imaging Storage-SCP, other than images sent to the Web Server Storage SCP, can be retrieved at a later time from Enterprise Imaging; however, the rate of return of the images will vary depending on the state of the images. The images can be in one of three states, as listed in Table 2-51.

Table 2-51: Image States for Image or other Composite DICOM Object Sent by Remote AE (SCP)

Image State	Description
Online	The image is immediately available.
Nearline	The image is automatically available. However, there may be a small delay in retrieval time.
Offline	The image requires manual assistance to become online. The retrieval request will return a failure code.

Figure 2.2-8 illustrates the sequencing of activity when new DICOM objects are stored to Enterprise Imaging. Enterprise Imaging is applying data compression as described in chapter 2.2.1.6.3.6 Enterprise Imaging Data Compression.

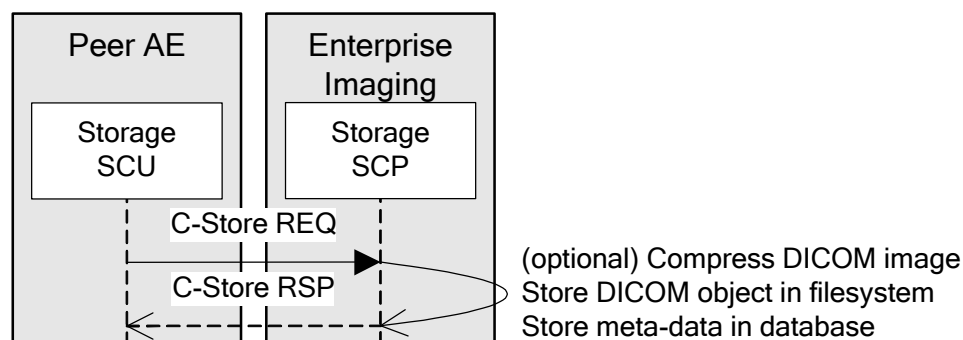

Figure 2.2-8: C-Store Sequencing of Activity

2.2.1.6.3.2 Accepted Presentation Contexts

Enterprise Imaging Storage-SCP will accept any of the Presentation Contexts listed in Table 2-52 for Storage.

Table 2-52: Presentation Contexts Accepted by Storage-SCP for Image DICOM Object Sent by Remote AE (SCP)

Presentation Context Table					
Abstract Syntax		Transfer Syntax		Role	Extended Negotiation
Name	UID	Name List	UID List		
		Implicit VR Little Endian	1.2.840.10008.1.2	SCP	-
		Explicit VR Little Endian	1.2.840.10008.1.2.1	SCP	-
		Deflated Explicit VR Little Endian	1.2.840.10008.1.2.1.99	SCP	-
		<i>Explicit VR Big Endian (Retired)</i>	<i>1.2.840.10008.1.2.2</i>	<i>SCP</i>	<i>-</i>
		RLE Lossless, PackBits	1.2.840.10008.1.2.5	SCP	-
		JPEG Process 1, baseline, lossy (8 bit)	1.2.840.10008.1.2.4.50	SCP	-
		JPEG Process 2,4, extended lossy (12 bit)	1.2.840.10008.1.2.4.51	SCP	-
		JPEG Process 14, lossless, Non-Hierarchical	1.2.840.10008.1.2.4.57	SCP	-
		JPEG Process 14, selection value 1, lossless, Non-Hierarchical, First-Order Prediction	1.2.840.10008.1.2.4.70	SCP	-
		JPEG-LS Lossless	1.2.840.10008.1.2.4.80	SCP	-
		JPEG-LS Lossy (Near-Lossless)	1.2.840.10008.1.2.4.81	SCP	-
		JPEG 2000 Image Compression (Lossless Only) ³³	1.2.840.10008.1.2.4.90	SCP	-
		JPEG 2000 Image Compression ³³	1.2.840.10008.1.2.4.91	SCP	-

Table 2-53: Presentation Contexts Accepted by Storage-SCP for Video DICOM Object Sent by Remote AE (SCP)

Presentation Context Table					
Abstract Syntax		Transfer Syntax		Role	Extended Negotiation
Name	UID	Name List	UID List		
		MPEG2 Main Profile @ Main Level	1.2.840.10008.1.2.4.100	SCP	-
		MPEG2 Main Profile @ High Level*	1.2.840.10008.1.2.4.101	SCP	-
		MPEG-4 AVC/H.264 High Profile / Level 4.1*	1.2.840.10008.1.2.4.102	SCP	
		MPEG-4 AVC/H.264 BD compatible* High Profile / Level 4.1	1.2.840.10008.1.2.4.103	SCP	
		MPEG-4 AVC/H.264 High Profile / Level 4.2*	1.2.840.10008.1.2.4.104 ³⁴	SCP	
		MPEG-4 AVC/H.264 High Profile / Level 4.2*	1.2.840.10008.1.2.4.105	SCP	

* MPEG-4 and MPEG2 High Level Transfer Syntaxes are supported by Core Server only for Storage (no display)

³³ Default support for these transfer syntaxes was removed as of 8.1.4. If these transfer syntaxes are required at a site, they can be added, though customers are encouraged to instead adopt the other supported transfer syntaxes, such as standard JPEG lossless.

³⁴ Supported as of EI 8.1.2 SP5

Table 2-54: Presentation Contexts Accepted by Storage-SCP for Other Composite DICOM Object Sent by Remote AE (SCP)

Presentation Context Table					
Abstract Syntax		Transfer Syntax		Role	Extended Negotiation
Name	UID	Name List	UID List		
		Implicit VR Little Endian	1.2.840.10008.1.2	SCP	-
		Explicit VR Little Endian	1.2.840.10008.1.2.1	SCP	-
		Deflated Explicit VR Little Endian	1.2.840.10008.1.2.1.99	SCP	-
		<i>Explicit VR Big Endian (Retired)</i>	<i>1.2.840.10008.1.2.2</i>	SCP	-

2.2.1.6.3.3 SOP Specific Conformance – Image or other Composite DICOM Object Sent by Remote AE (SCP)

Enterprise Imaging Storage-SCP conforms to the DICOM Storage Service Class as a Level 2 (Full) SCP. No elements are discarded or coerced by Enterprise Imaging. All Type 1, Type 2 and Type 3 attributes will be retained. Private attributes will be stored and included when the object is sent out again. Enterprise Imaging can decompress lossy compressed images and send them in uncompressed format. The Attribute Lossy Image Compression (0028,2110) remains "01".

Core Server Storage-SCP:

Upon successful storage of objects contained within a study, the study can be automatically transferred to a remote AE or returned in response to a retrieval request. Enterprise Imaging Storage-SCP can be configured to automatically archive or delete objects contained within a study. Studies may be manually transferred, archived or deleted through the graphical user interface.

Enterprise Imaging Storage-SCP will silently ignore duplicate objects by returning success (i.e. return status of 0000H).

Enterprise Imaging Storage-SCP can be configured to allow database level demographic updates (QC fixup) to objects received from trusted sources. This does not overwrite the former received object.

Enterprise Imaging Storage-SCP will return the C-STORE status codes shown in Table 2-55.

Table 2-55: C-STORE Response Status for Image or other Composite DICOM Object Sent by Enterprise Imaging Storage-SCP

Service Status	Further Meaning	Error Code	Reason
Success	Success	0x0000	Operation performed properly.
Failure	Processing Failure	0x0110	The operation was not successful.
Refused	SOP Class Not Supported	0x0122	
Refused	Not Authorized	0x0124	
Failure	Duplicate Invocation	0x0210	the Message ID (0000,0110) specified is allocated to another notification or operation
Failure	Unrecognized Operation	0x0211	the operation is not one of those agreed between the DIMSE-service-users
Refused	Out of resources	0xA700	Indicates that there was not enough storage space to store the image. Recovery from this condition is left to the administrative functions.

Service Status	Further Meaning	Error Code	Reason
	Unable To Calculate Number Of Matches	0xA701	
Error	Data set does not match SOP Class	0xA900	Indicates that the Data Set does not encode an instance of the SOP Class specified.
Warning	Coercion of Data Elements	0xB000	Values of attributes were modified by the SCP to ensure consistency with former received objects belonging to the same Patient/Study/Series entity.
Failure	Error: Cannot understand / unable to process, coercion error (Study IUID mismatch) for Series [IUID]	0xC000	The peer study IUID/ Series IUID send in the DICOM object header does not match peer study IUID/ Series IUID already existing in Enterprise Imaging.
Failure	Error: subsequent occurrence of rejected instance	0xC801	It is not allowed to re-use an Instance UID which has been previously rejected for another reason than " data retention policy expired".
Failure	Error: referenced SOP instances belong to different Study than Rejection Note	0xC802	In the DICOM object header of the KOS Rejection Note the Study must match the referenced Study of the Image Object to be deleted.

2.2.1.6.3.4 Presentation Context Acceptance Criterion

Enterprise Imaging Storage-SCP will accept any number of Storage Presentation Contexts per association request. Any one Abstract Syntax may be specified more than once in an association request, if the Transfer Syntaxes differ between the Presentation Contexts.

2.2.1.6.3.5 Transfer Syntax Selection Policies

Enterprise Imaging Storage-SCP supports all transfer syntaxes listed in Table 2-52, Table 2-53 and Table 2-54.

By default, Enterprise Imaging will choose a transfer syntax other than Implicit VR Little Endian if more than one is requested in a single Presentation Context. For images, as of version 8.1.1SP7, Enterprise Imaging will prefer a compressed Transfer Syntax over an uncompressed Transfer Syntax. Lossless Compression is preferred over Lossy Compression and Explicit VR Little Endian is preferred over Implicit VR Little Endian.

2.2.1.6.3.6 Enterprise Imaging Data Compression

2.2.1.6.3.6.1 Incoming Data

Uncompressed Image data

- By default, prior to making the images available, the system compresses monochrome uncompressed images upon inbound from modalities or other DICOM sources into JPEG Lossless.

Below monochrome uncompressed SOP classes are compressed into JPEG LOSSLESS 1.2.840.10008.1.2.70:

Table 2-56: Monochrome SOP Classes compression

SOP Class UID	SOP Class Name
1.2.840.10008.5.1.4.1.1.1	Computed Radiography Image IOD
1.2.840.10008.5.1.4.1.1.1.1	Digital X-Ray Image IOD – for Presentation
1.2.840.10008.5.1.4.1.1.1.1.1	Digital X-Ray Image IOD – for Processing
1.2.840.10008.5.1.4.1.1.1.2	Digital Mammography X-Ray Image IOD – for Presentation
1.2.840.10008.5.1.4.1.1.1.2.1	Digital Mammography X-Ray Image IOD – for Processing
1.2.840.10008.5.1.4.1.1.1.3	Digital Intra-Oral X-Ray Image IOD – for Presentation ³⁵
1.2.840.10008.5.1.4.1.1.1.3.1	Digital Intra-Oral X-Ray Image IOD – for Processing ³⁵
1.2.840.10008.5.1.4.1.1.2	Computed Tomography Image IOD
1.2.840.10008.5.1.4.1.1.2.1	Enhanced CT Image IOD ³⁵
1.2.840.10008.5.1.4.1.1.2.2	Legacy Converted Enhanced CT Image IOD ³⁵
1.2.840.10008.5.1.4.1.1.3.1	Ultrasound Multi-frame Image IOD
1.2.840.10008.5.1.4.1.1.4	Magnetic Resonance Image IOD
1.2.840.10008.5.1.4.1.1.4.1	Enhanced MR Image IOD ³⁵
1.2.840.10008.5.1.4.1.1.4.3	Enhanced MR Color Image IOD ³⁵
1.2.840.10008.5.1.4.1.1.4.4	Legacy Converted Enhanced MR Image IOD ³⁵
1.2.840.10008.5.1.4.1.1.6.1	Ultrasound Image IOD
1.2.840.10008.5.1.4.1.1.6.2	Enhanced US Volume Storage ³⁶
1.2.840.10008.5.1.4.1.1.7	SC Image Information Object Definition
1.2.840.10008.5.1.4.1.1.7.1	Multi-frame Single Bit Secondary Capture Image IOD ³⁵
1.2.840.10008.5.1.4.1.1.7.2	Multi-frame Grayscale Byte Secondary Capture Image IOD ³⁵
1.2.840.10008.5.1.4.1.1.7.3	Multi-frame Grayscale Word Secondary Capture Image IOD ³⁵
1.2.840.10008.5.1.4.1.1.7.4	Multi-frame True Color Secondary Capture Image IOD ³⁵
1.2.840.10008.5.1.4.1.1.12.1	X-Ray Angiographic Image IOD
1.2.840.10008.5.1.4.1.1.12.1.1	Enhanced X-Ray Angiographic Image IOD ³⁵
1.2.840.10008.5.1.4.1.1.12.2	X-Ray RF Image IOD
1.2.840.10008.5.1.4.1.1.12.2.1	Enhanced X-Ray RF Image IOD ³⁵
1.2.840.10008.5.1.4.1.1.13.1.1	X-Ray 3D Angiographic Image IOD ³⁵
1.2.840.10008.5.1.4.1.1.13.1.2	X-Ray 3D Craniofacial Image IOD ³⁵
1.2.840.10008.5.1.4.1.1.13.1.3	Breast Tomosynthesis Image IOD (compressed as of EI 8.1.1 SP6)
1.2.840.10008.5.1.4.1.1.13.1.4	Breast Projection X-Ray Image IOD ³⁵
1.2.840.10008.5.1.4.1.1.13.1.5	Breast Projection X-Ray Image IOD ³⁵
1.2.840.10008.5.1.4.1.1.20	Nuclear Medicine Image IOD
1.2.840.10008.5.1.4.1.1.77.1.1	VL Endoscopic Image IOD ³⁵
1.2.840.10008.5.1.4.1.1.77.1.2	VL Microscopic Image IOD ³⁵
1.2.840.10008.5.1.4.1.1.77.1.3	VL Slide-Coordinates Microscopic Image IOD ³⁵
1.2.840.10008.5.1.4.1.1.77.1.4	VL Photographic Image IOD ³⁵
1.2.840.10008.5.1.4.1.1.77.1.5.1	Ophthalmic Photography 8 Bit Image IOD ³⁵
1.2.840.10008.5.1.4.1.1.77.1.5.2	Ophthalmic Photography 16 Bit Image IOD ³⁵
1.2.840.10008.5.1.4.1.1.77.1.5.4	Ophthalmic Tomography Image IOD ³⁵
1.2.840.10008.5.1.4.1.1.77.1.5.5	Wide Field Ophthalmic Photography Stereographic Projection Image IOD ³⁵
1.2.840.10008.5.1.4.1.1.77.1.5.6	Wide Field Ophthalmic Photography 3D Coordinates Image IOD ³⁵
1.2.840.10008.5.1.4.1.1.77.1.5.7	Ophthalmic Optical Coherence Tomography En Face Image Information Object Definition ³⁵
1.2.840.10008.5.1.4.1.1.77.1.6	VL Whole Slide Microscopy Image IOD ³⁵
1.2.840.10008.5.1.4.1.1.128	Positron Emission Tomography Image IOD ³⁵

³⁵ Compression applied as of Enterprise Imaging 8.1.2 SP5³⁶ Compression applied as of Enterprise Imaging 8.1.5

SOP Class UID	SOP Class Name
1.2.840.10008.5.1.4.1.1.130	Enhanced PET Image IOD ³⁵
1.2.840.10008.5.1.4.1.1.128.1	Legacy Converted Enhanced PET Image IOD ³⁵
1.2.840.10008.5.1.4.1.1.481.1	RT Image IOD ³⁵
1.2.840.10008.5.1.4.1.1.66.4	Segmentation Storage ³⁷
1.2.840.10008.5.1.4.1.1.481.2	RT Dose Storage ³⁷
1.2.840.10008.5.1.4.1.1.3	Ultrasound Multi-frame Image Storage (Retired)
1.2.840.10008.5.1.4.1.1.5	Nuclear Medicine Image Storage (Retired) ³⁵
1.2.840.10008.5.1.4.1.1.12.3	X-Ray Angiographic Bi-plane Image Storage (Retired) ³⁵
1.2.840.10008.5.1.4.1.1.6	Ultrasound Image Storage (Retired)

- Enterprise Imaging 8.1.2 SP5 (and higher versions) compresses following RGB uncompressed images into JPEG LOSSLESS 1.2.840.10008.1.2.70 upon inbound from modalities or other DICOM sources.

Table 2-57: RGB SOP Classes compression

SOP Class UID	SOP Class Name
1.2.840.10008.5.1.4.1.1.1.2	Digital Mammography X-Ray Image IOD – for Presentation
1.2.840.10008.5.1.4.1.1.2	Computed Tomography Image IOD
1.2.840.10008.5.1.4.1.1.4	Magnetic Resonance Image IOD
1.2.840.10008.5.1.4.1.1.4.1	Enhanced MR Image IOD
1.2.840.10008.5.1.4.1.1.4.3	Enhanced MR Color Image IOD
1.2.840.10008.5.1.4.1.1.5	Nuclear Medicine Image Storage (Retired)
1.2.840.10008.5.1.4.1.1.6	Ultrasound Image Storage (Retired)
1.2.840.10008.5.1.4.1.1.6.1	Ultrasound Image IOD
1.2.840.10008.5.1.4.1.1.7	SC Image Information Object Definition
1.2.840.10008.5.1.4.1.1.7.4	Multi-frame True Color Secondary Capture Image IOD
1.2.840.10008.5.1.4.1.1.20	Nuclear Medicine Image IOD
1.2.840.10008.5.1.4.1.1.77.1.1	VL Endoscopic Image IOD
1.2.840.10008.5.1.4.1.1.77.1.2	VL Microscopic Image IOD
1.2.840.10008.5.1.4.1.1.77.1.3	VL Slide-Coordinates Microscopic Image IOD
1.2.840.10008.5.1.4.1.1.77.1.4	VL Photographic Image IOD
1.2.840.10008.5.1.4.1.1.77.1.5.1	Ophthalmic Photography 8 Bit Image IOD
1.2.840.10008.5.1.4.1.1.77.1.5.5	Wide Field Ophthalmic Photography Stereographic Projection Image IOD
1.2.840.10008.5.1.4.1.1.77.1.5.6	Wide Field Ophthalmic Photography 3D Coordinates Image IOD
1.2.840.10008.5.1.4.1.1.3.1	Ultrasound Multi-frame Image Storage ³⁷
1.2.840.10008.5.1.4.1.1.3	Ultrasound Multi-frame Image Storage (Retired) ³⁷

- Enterprise Imaging 8.1 compresses objects bigger than 4 MB via a TEMP disk space in the Incoming Cache Storage System Group (SSG) whereas smaller objects are always compressed in memory (Note: EI 8.0 is compressing all objects in memory).
- Note that the target format is configurable (i.e. via a Professional Service, and not possible directly via Admin desktop). For example: change to LOSSY compression (important remark: not recommended, and not tested!).

Non-Image data, compressed image data

³⁷ Compression applied as of Enterprise Imaging 8.1.5

- Non-Image documents (SR etc.) will by default be retained in the original format and are not compressed.
- Images ingested with a negotiated transfer syntax which includes compression, shall be stored using the same compression encoding.
- Images which have been formerly compressed with a lossy compression encoding, but are ingested uncompressed, shall not be compressed again.

Example

A Mammography modality negotiates un-compressed transfer syntax for storing gray scale studies to Enterprise Imaging. Enterprise Imaging uses the following compression rules when receiving data into Incoming cache and/or Midline storage to improve display performance:

- Compression to JPEG LOSSLESS 1.2.840.10008.1.2.4.70 for the following SOP Classes:
 - 1.2.840.10008.5.1.4.1.1.1.2
 - 1.2.840.10008.5.1.4.1.1.1.2.1
- No compression is applied for non-image objects:
 - 1.2.840.10008.5.1.4.1.1.88.11
 - 1.2.840.10008.5.1.4.1.1.104.1
 - 1.2.840.10008.5.1.4.1.1.11.1
- For software versions lower than EI 8.1.1 SP6 no compression is applied for DBT SOP Class 1.2.840.10008.5.1.4.1.1.13.1.3. As of EI 8.1.1 SP6 compression is applied.

2.2.1.6.3.6.2 Archiving Data

Images are archived to the Archive Storage System Group (SSG) the way they were stored into the system. Additionally, studies are stored to a ZIP container to reduce the number of objects per file on disk.

2.2.1.6.4 Real World Activity – Modality Performed Procedure Step-SCP

2.2.1.6.4.1 Description and Sequencing of Activity

Enterprise Imaging MPPS-SCP acts as an SCP to DIMSE N-CREATE or N-SET Modality Performed Procedure Steps. Attribute values for the performed procedure step are stored within the Core Server's data repository.

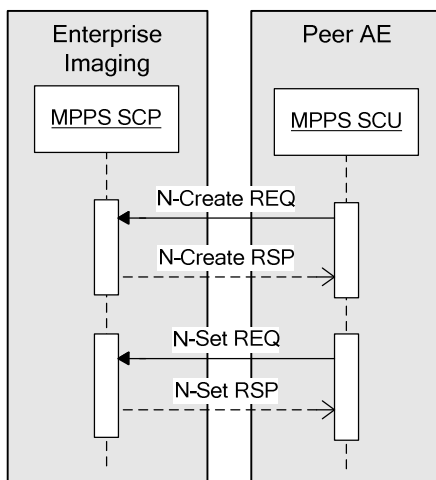

Figure 2.2-9: MPPS SCP N-Create and N-Set Sequence of Activity

2.2.1.6.4.2 Accepted Presentation Contexts

Table 2-58: Presentation Contexts Accepted by Modality Performed Procedure Step SCP

Presentation Context Table					
Abstract Syntax		Transfer Syntax		Role	Extended Negotiation
Name	UID	Name List	UID List		
Modality Performed Procedure Step	1.2.840.10008.3.1.2.3.3	Implicit VR Little Endian	1.2.840.10008.1.2	SCP	None

2.2.1.6.4.3 SOP Specific Conformance

Enterprise Imaging MPPS-SCP supports the following N-CREATE Modality Performed Procedure Step attributes:

Table 2-59: Modality Performed Procedure Step SOP Class N-CREATE Attributes

Module	Attribute Name	Tag	Remarks
SOP Common	Specific Character Set	(0008,0005)	
Performed Procedure Step	Patient's Name	(0010,0010)	
Relationship	Patient ID	(0010,0020)	
	Patient Birth Date	(0010,0030)	
	Patient's Sex	(0010,0040)	
	Scheduled Step Attribute Sequence	(0040,0270)	See Note 1
	>Accession Number	(0008,0050)	
	>Referenced Study Sequence	(0008,1110)	
	>>Referenced SOP Instance UID	(0008,1155)	
	>Referenced Patient Sequence	(0008,1120)	
	>>Referenced SOP Instance UID	(0008,1155)	
	>Performing Physician's Name	(0008,1050)	
	>Study Instance UID	(0020,000D)	See Note 1
	>Requested Procedure Description	(0032,1060)	
	>Scheduled Procedure Step Description	(0040,0007)	
	>Scheduled Action Item Code Seq.	(0040,0008)	
	>>Code Value	(0008,0100)	

Module	Attribute Name	Tag	Remarks
	>>Coding Scheme Designator	(0008,0102)	
	>>Code Meaning	(0008,0104)	
	>Scheduled Procedure Step ID	(0040,0009)	
	>Requested Procedure ID	(0040,1001)	
Performed Procedure Step Information	Procedure Code Sequence	(0008,1032)	
	>Code Value	(0008,0100)	
	>Coding Scheme Designator	(0008,0102)	
	>Code Meaning	(0008,0104)	
	Performed Station AE Title	(0040,0241)	See Note 1
	Performed Station Name	(0040,0242)	
	Performed Location	(0040,0243)	
	Performed Procedure Step Start Date	(0040,0244)	See Note 1
	Performed Procedure Step Start Time	(0040,0245)	See Note 1
	Performed Procedure Step End Date	(0040,0250)	
	Performed Procedure Step End Time	(0040,0251)	
	Performed Procedure Step Status	(0040,0252)	See Note 1 Must have status 'In Progress'. Any other status will result in an error.
	Performed Procedure Step ID	(0040,0253)	See Note 1
	Performed Procedure Step Description	(0040,0254)	
	Performed Procedure Type Description	(0040,0255)	
Image Acquisition Results	Modality	(0008,0060)	See Note 1
	Study ID	(0020,0010)	
	Performed Protocol Code Sequence	(0040,0260)	
	>Code Value	(0008,0100)	
	>Coding Scheme Designator	(0008,0102)	
	>Code Meaning	(0008,0104)	
	Performed Series Sequence	(0040,0340)	
	>Retrieve AE Title	(0008,0054)	
	>Series Description	(0008,103E)	
	>Performing Physician's Name	(0008,1050)	
	>Operator's Name	(0008,1070)	
	>Referenced Image Sequence	(0008,1140)	
	>>Referenced SOP Class UID	(0008,1150)	
	>>Referenced SOP Instance UID	(0008,1155)	
	>Protocol Name	(0018,1030)	
	>Series Instance UID	(0020,000E)	
	> Referenced Non-Image Composite SOP Instance Sequence	(0040,0220)	
	>>Referenced SOP Class UID	(0008,1150)	
	>>Referenced SOP Instance UID	(0008,1155)	

Note 1: These attributes must be present and not empty.

Enterprise Imaging MPPS-SCP returns one of the following status codes in the N-CREATE-RSP:

Table 2-60: N-CREATE Response Status codes

Service Status	Further Meaning	Error Code	Reason
Success	Success	0x0000	The SCP has completed the operation successfully.
Failure	No Such Attribute	0x0105	the Tag for the specified Attribute was not recognized
Failure	Invalid Attribute Value	0x0106	If the Performed Procedure Step Status has a value other than In Progress.
Warning	Attribute List Error	0x0107	one or more Attribute Values were not read/modified/created because the specified Attribute was not recognized
Failure	Processing Failure	0x0110	Sent when an SCU attempts to create a MPPS which SOP Instance UID has already existed, or when Enterprise Imaging failed to create the MPPS record in the system.
Failure	Duplicate SOP Instance	0x0111	the new managed SOP Instance Value supplied by the invoking DIMSE-service-user was already registered for a managed SOP Instance of the specified SOP Class
Warning	Attribute Value Out Of Range	0x0116	the Attribute Value specified was out of range or otherwise inappropriate
Failure	Invalid Object Instance	0x0117	the SOP Instance UID specified implied a violation of the UID construction rules
Failure	No Such SOP class	0x0118	the SOP Class was not recognized
Failure	Missing Attribute	0x0120	a required Attribute was not supplied
Failure	Missing Attribute Value	0x0121	One or more Type 1 attributes are either not available or are empty
Refused	Not Authorized	0x0124	
Failure	Duplicate Invocation	0x0210	the Message ID (0000,0110) specified is allocated to another notification or operation
Failure	Unrecognized Operation	0x0211	the operation is not one of those agreed between the DIMSE-service-users
Failure	Mistyped Argument	0x0212	one of the parameters supplied has not been agreed for use on the Association between the DIMSE-service-users

All attributes in the following table may be updated by the MPPS SCU using the N-SET Service.

Table 2-61: Modality Performed Procedure Step SOP Class N-SET Attributes

Module	Attribute Name	Tag	Remarks
Performed Procedure Step Information	Procedure Code Sequence	(0008,1032)	
	>Code Value	(0008,0100)	
	>Coding Scheme Designator	(0008,0102)	
	>Code Meaning	(0008,0104)	
	Performed Procedure Step End Date	(0040,0250)	See Note 2
	Performed Procedure Step End Time	(0040,0251)	See Note 2
	Performed Procedure Step Status	(0040,0252)	
Image Acquisition Results	Performed Procedure Step Description	(0040,0254)	
	Performed Procedure Type Description	(0040,0255)	
	Performed Protocol Code Sequence	(0040,0260)	
	>Code Value	(0008,0100)	
	>Coding Scheme Designator	(0008,0102)	
	>Code Meaning	(0008,0104)	
	Performed Series Sequence	(0040,0340)	See Note 2
	>Retrieve AE Title	(0008,0054)	

Module	Attribute Name	Tag	Remarks
	>Series Description	(0008,103E)	
	>Performing Physician's Name	(0008,1050)	
	>Operator's Name	(0008,1070)	
	>Referenced Image Sequence	(0008,1140)	
	>>Referenced SOP Class UID	(0008,1150)	
	>>Referenced SOP Instance UID	(0008,1155)	
	>Protocol Name	(0018,1030)	
	>Series Instance UID	(0020,000E)	
	> Referenced Non-Image Composite SOP Instance Sequence	(0040,0220)	
	>>Referenced SOP Class UID	(0008,1150)	
	>>Referenced SOP Instance UID	(0008,1155)	

Note 2: These attributes must be present and not empty.

Enterprise Imaging MPPS-SCP returns one of the following status codes in the N-SET-RSP:

Table 2-62: N-SET Response Status Codes

Service Status	Further Meaning	Error Code	Reason
Success	Success	0x0000	The SCP has completed the operation successfully.
Failure	No Such Attribute	0x0105	the Tag for the specified Attribute was not recognized
Failure	Invalid Attribute Value	0x0106	If the Performed Procedure Step Status is neither In Progress, Completed nor Discontinued
Warning	Attribute List Error	0x0107	one or more Attribute Values were not read/modified/created because the specified Attribute was not recognized
Failure	Processing Failure	0x0110	Sent when an SCU attempts to update a performed procedure step which is COMPLETED or DISCONTINUED, or when it attempts to update an attribute that cannot be updated
Failure	No Such Object Instance	0x0112	the SOP Instance was not recognized
Warning	Attribute Value Out Of Range	0x0116	the Attribute Value specified was out of range or otherwise inappropriate
Failure	Invalid Object Instance	0x0117	the SOP Instance UID specified implied a violation of the UID construction rules
Failure	No Such SOP class	0x0118	the SOP Class was not recognized
Failure	Class Instance Conflict	0x0119	the specified SOP Instance is not a member of the specified SOP class
Failure	Missing Attribute Value	0x0121	One or more Type 1 attributes are either not present or are empty
Refused	Not Authorized	0x0124	
Failure	Duplicate Invocation	0x0210	the Message ID (0000,0110) specified is allocated to another notification or operation
Failure	Unrecognized Operation	0x0211	the operation is not one of those agreed between the DIMSE-service-users
Failure	Mistyped Argument	0x0212	one of the parameters supplied has not been agreed for use on the Association between the DIMSE-service-users
Failure	Resource Limitation	0x0213	the operation was not performed due to resource limitation

Table 2-63: Presentation Contexts Proposed by Modality Performed Procedure Step SCP

Presentation Context Table					
Abstract Syntax		Transfer Syntax		Role	Extended Negotiation
Name	UID	Name List	UID List		
Modality Performed Procedure Step	1.2.840.10008.3.1.2.3.3	Implicit VR Little Endian	1.2.840.10008.1.2	SCU	None

2.2.1.6.5 Real World Activity – Modality Worklist-SCP

2.2.1.6.5.1 Description and Sequencing of Activity

Enterprise Imaging Modality Worklist-SCP will respond to query requests that are sent to it by a Modality Worklist Find SCU. Modality Worklist-SCP creates the modality worklist items based on the scheduled order messages (HL7 ORM) sent from the RIS.

Figure 2.2-10 illustrates the sequencing of activity when Enterprise Imaging receives a Modality Worklist query from a peer AE.

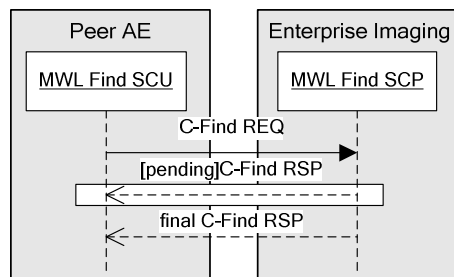

Figure 2.2-10 MWL Query Sequencing of Activity

2.2.1.6.5.2 Accepted Presentation Contexts

Table 2-64: Presentation Contexts Accepted by Modality Worklist SCP

Presentation Context Table					
Abstract Syntax		Transfer Syntax		Role	Extended Negotiation
Name	UID	Name List	UID List		
Modality Worklist IM - Find	1.2.840.10008.5.1.4.31	Implicit VR Little Endian	1.2.840.10008.1.2	SCP	None
		Explicit VR Little Endian	1.2.840.10008.1.2.1		

2.2.1.6.5.3 SOP Specific Conformance

Modality Worklist-SCP provides standard conformance to the DICOM Basic Worklist Management Service Class.

Modality Workflow-SCP supports all required matching key types:

Table 2-65: Matching Key Types

Matching Key Types	
SV	single valued match
WC	wild card match

UI	List of UID matching
SQ	sequence match
DR	date range match

Modality Worklist-SCP supports all required return keys as long as the data is available from the RIS. Modality Worklist-SCP only returns Modality Worklist Items that have Scheduled Procedure Step Status (0040,0020) as SCHEDULED.

Modality Worklist-SCP supports case-insensitive matching for Patient Name (0010,0010). Modality Worklist-SCP does not support fuzzy semantic matching of patient names.

If the received request specifies an unsupported Specific Character Set (0008,0005) element, Modality Worklist-SCP will try to find any matching records using the constraints specified in the request as is without any modification.

Modality Worklist-SCP supports the following elements for this SOP class:

Table 2-66: Modality Worklist Information Model Attributes

Module	Attribute Name	Tag	Match	Return
SOP Common	Specific Character Set	(0008,0005)		1C
Scheduled Procedure Step	Scheduled Procedure Step Sequence	(0040,0100)	SQ	1
	>Modality	(0008,0060)	SV	1
	>Requested Contrast Agent	(0032,1070)		2C
	>Scheduled Station AE Title	(0040,0001)	SV	1
	>Scheduled Procedure Step Start Date	(0040,0002)	DR	1
	>Scheduled Procedure Step Start Time	(0040,0003)	DR	1
	>Scheduled Performing Physician	(0040,0006)		2
	>Scheduled Procedure Step Desc	(0040,0007)		1C
	>Scheduled Protocol Code Sequence	(0040,0008)		1C
	>>Code Value	(0008,0100)		1C
	>>Code Schema Designator	(0008,0102)		1C
	>Scheduled Procedure Step ID	(0040,0009)		1
	>Scheduled Station Name	(0040,0010)		2
	>Scheduled Procedure Step Location	(0040,0011)		2
	>Pre-Medication	(0040,0012)		2C
Requested Procedure	Referenced Study Sequence	(0008,1110)		2
	>Referenced SOP Class UID	(0008,1150)		1C
	>Referenced SOP Instance UID	(0008,1155)		1C
	Study Instance UID	(0020,000D)		1
	Requested Procedure Description	(0032,1060)		1C
	Requested Procedure Code Sequence	(0032,1064)		1C
	>Code Value	(0008,0100)		1C
	>Coding Scheme Designator	(0008,0102)		1C
	Requested Procedure ID	(0040,1001)	SV	1
	Requested Procedure Priority	(0040,1003)		2
Patient Transport Arrangements	(0040,1004)		2	
Imaging Service Request	Accession Number	(0008,0050)	SV	2
	Referring Physician Name	(0008,0090)		2
	Requesting Physician	(0032,1032)		2
Visit Identification	Admission ID	(0038,0010)		2
Visit Status	Current Patient Location	(0038,0300)		2
Visit Relationship	Referenced Patient Sequence	(0008,1120)		2

Module	Attribute Name	Tag	Match	Return
	>Referenced SOP Class UID	(0008,1150)		2
	>Referenced SOP Instance UID	(0008,1155)		2
Patient Identification	Patient Name	(0010,0010)	WC	1
	Patient ID	(0010,0020)	SV	1
	Issuer of Patient ID	(0010,0021)	SV ³⁸	3
	Issuer of Patient ID Qualifiers Sequence	(0010,0024)	SV ³⁸	3
	>Universal Entity ID ³⁹	(0040,0032)		3
	>Universal Entity ID Type ³⁹	(0040,0033)		1C
	>Identifier Type Code ³⁹	(0040,0035)		3
Patient Demographic	Patient Birth Date	(0010,0030)		2
	Patient Birth Time	(0010,0032)		2
	Patient Sex	(0010,0040)		2
	Patient Weight	(0010,1030)		2
	Confidentiality Constraint	(0040,3001)		2
Patient Medical	Medical Alerts	(0010,2000)		2
	Contrast Allergies	(0010,2110)		2
	Pregnancy Status	(0010,21C0)		2
	Special Needs	(0038,0050)		2
	Patient State	(0038,0500)		2

Modality Worklist-SCP returns one of the following status codes in the Modality Worklist C-FIND response:

Table 2-67: C-FIND Response Status Codes

Service Status	Further Meaning	Error Code	Description
Success	Success	0x0000	Operation performed properly
Pending	Pending	0xFF00	Matches are continuing - Current Match is supplied and any Optional keys were supported in the same manner as Required keys.
Pending	Pending Warning	0xFF01	Matches are continuing – Warning that one or more Optional keys were not supported for existence for this identifier.
Cancel	Cancel	0xFE00	It is terminated due to Cancel request.
Refused	SOP Class Not Supported	0x0122	
Refused	Not Authorized	0x0124	
Failure	Duplicate Invocation	0x0210	the Message ID (0000,0110) specified is allocated to another notification or operation
Failure	Unrecognized Operation	0x0211	the operation is not one of those agreed between the DIMSE-service-users
Failure	Identifier Does Not Match SOP Class	0xA900	Sent when an SCU attempts to request an Identifier that doesn't match SOP Class attributes.
Failure	Unable To Process	0xC000	Sent when the SCP is Unable to Process the SCU request.

³⁸ Attribute only taken into account as matching criteria when a value is present for the Patient ID tag in the MWL Query.

³⁹ Universal Entity ID / types supported as of Enterprise Imaging 8.1.4.

2.2.1.6.5.4 Presentation Context Acceptance Criterion – Modality Worklist (SCP)

Modality Worklist-SCP will accept any number of Modality Worklist Presentation Contexts per association request. Any one Abstract Syntax may be specified more than once in an association request, if the Transfer Syntaxes differ between the Presentation Contexts.

2.2.1.6.5.5 Transfer Syntax Selection Policies – Modality Worklist (SCP)

Modality Worklist-SCP prefers Explicit VR Little Endian if proposed, otherwise it will choose Implicit VR Little Endian.

2.2.1.6.6 Real World Activity – Enterprise Imaging Query/Retrieve-SCP

2.2.1.6.6.1 Description and Sequencing of Activity – Find Object (SCP)

Enterprise Imaging Query/Retrieve-SCP will respond to query requests that are sent to it by a Query/Retrieve SCU. The latency for retrieval of SOP Instances is dependent on the object state, as specified in Table 2-68.

Figure 2.2-11 illustrates the sequencing of activity when Enterprise Imaging Query/Retrieve-SCP receives a DICOM query from a peer AE.

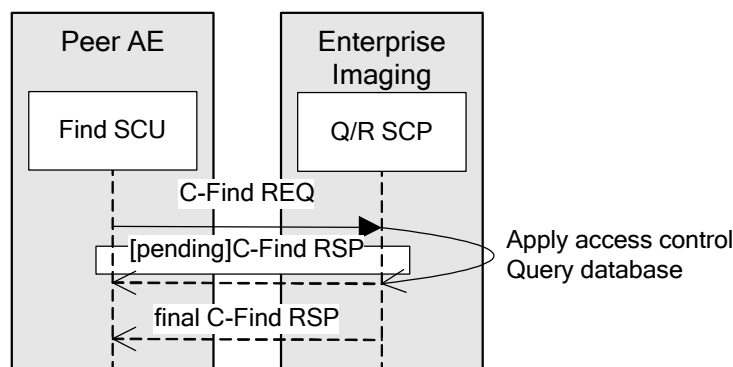

Figure 2.2-11: Query Sequencing of Activity

Table 2-68: Image States for Find Object (SCP)

Image State	Description
Online	The image is immediately available.
Nearline	The image is automatically available. However, there may be a small delay in retrieval time.
Offline	The image requires manual assistance to become online. The retrieval request will return a failure code.

2.2.1.6.6.2 Accepted Presentation Contexts – Find Object (SCP)

Enterprise Imaging Query/Retrieve-SCP will accept any of the Presentation Contexts listed in Table 2-69 for Find.

Table 2-69: Presentation Contexts Accepted for Find Object (SCP)

Presentation Context Table					
Abstract Syntax		Transfer Syntax		Role	Extended Negotiation
Name	UID	Name List	UID List		
Study Root Query/Retrieve IM Find	1.2.840.10008.5.1.4.1.2.2.1	Implicit VR Little Endian	1.2.840.10008.1.2	SCP	See Note 1

Note 1: C-Find Extended Negotiation will be supported. Enterprise Imaging Query/Retrieve-SCP will respond with the information in Table 2-70.

Table 2-70: FIND Extended Negotiation

Field Name	Value	Description of Field
Relational-queries	1	Relational queries supported.

2.2.1.6.6.3 SOP Specific Conformance – Find Object (SCP)

Enterprise Imaging Query/Retrieve-SCP provides standard conformance to the DICOM Query/Retrieve Service Class as an SCP.

Enterprise Imaging Query/Retrieve-SCP supports the Relational-queries extended SCP behavior. Matching for all PN VR attributes, but also for Study Description (0008,1030), Institution Name (0008,0080) and Institutional Department Name (0008,1040) is case-insensitive. Supported Return Keys are configurable. There is a trade-off between the extent of supported Return Keys and the size of the database.

Enterprise Imaging Query/Retrieve-SCP provides support for the Instance Availability (0008,0056) Data Element on Study, Series and Instance Level, but not on Patient Level.

Table 2-71: Patient Level Attributes for Find Object (SCP)

Description	Tag	Support
Patient Name	(0010,0010)	Wild Card Matching / Returned
Patient ID	(0010,0020)	Wild Card Matching / Returned
Issuer of Patient ID	(0010,0021)	Single Value Matching / Returned
Patient Birth Date	(0010,0030)	Range Matching / Returned
Patient Sex	(0010,0040)	Wild Card Matching / Returned
Other Patient ID Sequence	(0010,1002)	Sequence Matching / Returned
> Patient ID	(0010,0020)	Single Value Matching / Returned
> Issuer of Patient ID	(0010,0021)	Single Value Matching / Returned
All additional configured Patient Level Return Keys		Returned Only

Table 2-72: Study Level Attributes for Find Object (SCP)

Description	Tag	Support
Study Instance UID	(0020,000D)	List of UID Matching / Returned
Study ID	(0020,0010)	Wild Card Matching / Returned

Description	Tag	Support
Study Date	(0008,0020)	Range Matching ⁴⁰ / Returned
Study Time	(0008,0010)	Range Matching ⁴⁰ / Returned
Accession Number	(0008,0050)	Wild Card Matching / Returned
Modalities in Study	(0008,0061)	Single Value Matching / Returned
Referring Physician's Name	(0008,0090)	Wild Card Matching / Returned
Study Description	(0008,1030)	Wild Card Matching / Returned
Study Status ID	(0032,000A)	Single Value Matching / Returned
Number of Study Related Series	(0020,1000)	Returned Only
Number of Study Related Instances	(0020,1208)	Returned Only
All additional configured Study Level Return Keys		Returned Only

Table 2-73: Series Level Attributes for Find Object (SCP)

Description	Tag	Support
Series Instance UID	(0020,000E)	List of UID Matching / Returned
Series Number	(0020,0011)	Wild Card Matching / Returned
Modality	(0008,0060)	Wild Card Matching / Returned
Institution Name	(0008,0080)	Wild Card Matching / Returned
Institutional Department Name	(0008,1040)	Wild Card Matching / Returned
Body Part Examined	(0018,0015)	Wild Card Matching / Returned
Laterality	(0020,0060)	Wild Card Matching / Returned
Request Attribute Sequence	(0040,0275)	
>Requested Procedure ID	(0040,1001)	Wild Card Matching / Returned
>Reason for the Requested Procedure	(0040,1002)	Returned Only
>Reason for Requested Procedure Code Sequence	(0040,100A)	
>>Code Value	(0008,0100)	Returned Only
>>Coding Scheme Designator	(0008,0102)	Returned Only
>>Coding Scheme Version	(0008,0103)	Returned Only
>>Code Meaning	(0008,0104)	Returned Only
>Scheduled Procedure Step ID	(0040,0009)	Wild Card Matching / Returned
>Scheduled Procedure Step Description	(0040,0007)	Returned Only
>Scheduled Protocol Code Sequence	(0040,0008)	
>>Code Value	(0008,0100)	Returned Only
>>Coding Scheme Designator	(0008,0102)	Returned Only
>>Coding Scheme Version	(0008,0103)	Returned Only
>>Code Meaning	(0008,0104)	Returned Only

⁴⁰Matching keys for Date and Time are combined. For example, a Study Date of "20060705-20060707" and a Study Time of "1000-1800" will match the time period of July 5, 10am until July 7, 6pm, rather than the three time periods of 10am until 6pm on each of July 5, July 6 and July 7.

Description	Tag	Support
Performed Procedure Step Start Date	(0040,0244)	Range Matching ⁴⁰ / Returned
Performed Procedure Step Start Time	(0040,0245)	Range Matching ⁴⁰ / Returned
Number of Series Related Instances	(0020,1209)	Returned Only
All additional configured Series Level Return Keys		Returned Only

Table 2-74: Instance Level Attributes for Find Object (SCP)

Description	Tag	Support
Instance Number	(0020,0013)	Wild Card Matching / Returned
SOP Instance UID	(0008,0018)	List of UID Matching / Returned
SOP Class UID	(0008,0016)	List of UID Matching / Returned
Content Date	(0008,0023)	Range Matching ⁴⁰ / Returned
Content Time	(0008,0033)	Range Matching ⁴⁰ / Returned
Concept Name Code Sequence	(0040,A043)	
>>Code Value	(0008,0100)	Single Value Matching / Returned
>>Coding Scheme Designator	(0008,0102)	Single Value Matching / Returned
>>Coding Scheme Version	(0008,0103)	Returned Only
>>Code Meaning	(0008,0104)	Returned Only
Completion Flag	(0040,A491)	Single Value Matching / Returned
Verification Flag	(0040,A493)	Single Value Matching / Returned
All additional configured Instance Level Return Keys		Returned Only

Enterprise Imaging Query/Retrieve-SCP returns one of the following status codes to a C-FIND request.

Table 2-75: C-FIND Status Codes for Find Object (SCP)

Service Status	Further Meaning	Error Code	Description
Success	Success	0x0000	Operation performed properly
Pending	Pending	0xFF00	All Optional Keys are supported in the same manner as Required Keys.
Cancel	Cancel	0xFE00	The original requester canceled this operation
Refused	SOP Class Not Supported	0x0122	
Refused	Not Authorized	0x0124	
Failure	Duplicate Invocation	0x0210	the Message ID (0000,0110) specified is allocated to another notification or operation
Failure	Unrecognized Operation	0x0211	the operation is not one of those agreed between the DIMSE-service-users
Failure	Identifier Does Not Match SOP Class	0xA900	The specified identifier contains a request that does not match the specified SOP Class.
Failure	Unable To Process	0xC000	For some reason (such as the database being off-line) this request cannot be processed at this time

2.2.1.6.6.4 Presentation Context Acceptance Criterion – Find Object (SCP)

Enterprise Imaging Query/Retrieve-SCP will accept any number of Find Presentation Contexts per association request. Any one Abstract Syntax may be specified more than once in an association request, if the Transfer Syntaxes differ between the Presentation Contexts.

2.2.1.6.6.5 Transfer Syntax Selection Policies – Find Object (SCP)

Explicit VR Little Endian is preferred over Implicit VR Little Endian.

2.2.1.6.7 Real World Activity – Enterprise Imaging Move-SCP

2.2.1.6.7.1 Description and Sequencing of Activity

Enterprise Imaging will transmit images that have been sent to it previously, driven by user requests. An association is established when the user initiates a transmit request. Enterprise Imaging Move-SCP will establish an association automatically in response to a C-MOVE request.

Figure 2.2-12 illustrates the sequencing of activity when Enterprise Imaging Move-SCP received a C-Move request from a Move-SCU. Pending C-Move responses are, by default, sent on a periodic basis to keep the inbound DICOM association alive. The pending response interval is configurable.

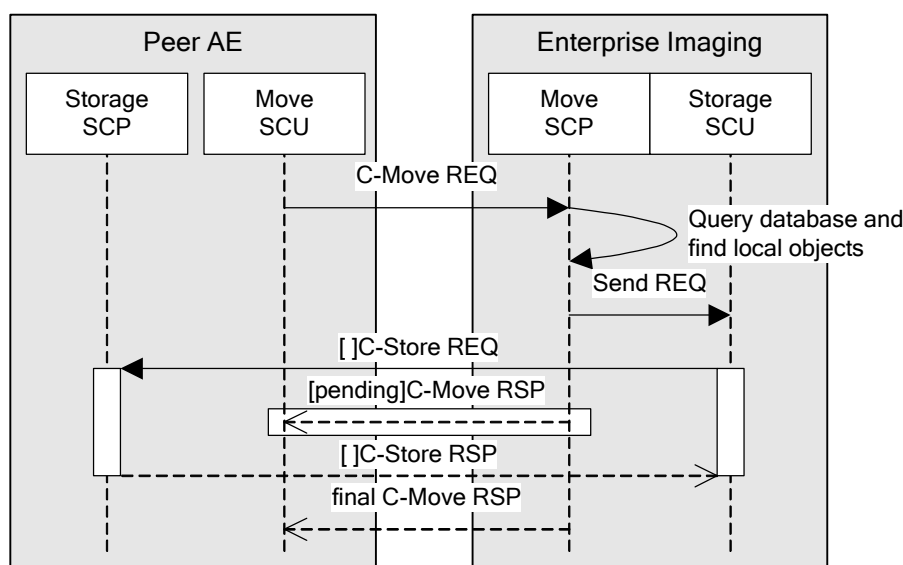

Figure 2.2-12: Retrieve Sequencing of Activity

2.2.1.6.7.2 Accepted Presentation Contexts – Move Object (SCP)

Enterprise Imaging Move-SCP will accept any of the Presentation Contexts listed in Table 2-76 for Move.

Table 2-76: Presentation Contexts Accepted by Enterprise Imaging for Move Object (SCP)

Presentation Context Table					
Abstract Syntax		Transfer Syntax		Role	Extended Negotiation
Name	UID	Name List	UID List		
Study Root Query/Retrieve IM Move	1.2.840.10008.5.1.4.1.2.2.2	Implicit VR Little Endian	1.2.840.10008.1.2	SCP	See Note 1

Note 1: C-Move Extended Negotiation will be supported. Enterprise Imaging Move-SCP will respond with the information in Table 2-77: MOVE Extended Negotiation.

Table 2-77: MOVE Extended Negotiation

Field Name	Value	Description of Field
Relational-retrieve	1	Relational retrieve supported.

2.2.1.6.7.3 SOP Specific Conformance – Move Object (SCP)

Enterprise Imaging Move-SCP will try to establish an association with the move destination specified in the Move request. One or more of the Presentation Contexts listed in the Store section of this document may be negotiated in this association.

Enterprise Imaging Move-SCP returns one of the following status codes to a C-MOVE request.

Table 2-78: C-MOVE Status Codes for Move Object (SCP)

Service Status	Further Meaning	Error Code	Description
Success	Success	0x0000	Operation performed successfully
Pending	Pending	0xFF00	The storage operation is continuing
Refused	SOP Class Not Supported	0x0122	
Refused	Not Authorized	0x0124	
Failure	Duplicate Invocation	0x0210	the Message ID (0000,0110) specified is allocated to another notification or operation
Failure	Unrecognized Operation	0x0211	the operation is not one of those agreed between the DIMSE-service-users
Refused	Out Of Resources	0xA700	
Refused	Unable To Calculate Number Of Matches	0xA701	
Refused	Unable To Perform Sub Operations	0xA702	Unable to perform storage of images to move destination
Refused	Move Destination Unknown	0xA801	The destination of this move request is unknown
Failure	Identifier Does Not Match SOP Class	0xA900	The specified identifier contains a request that does not match the specified SOP Class
Warning	One Or More Failures	0xB000	Storage complete with one or more failures.
Failure	Unable To Process	0xC000	For some reason (such as the database being off-line) this request cannot be processed at this time

2.2.1.6.7.4 Presentation Context Acceptance Criterion – Move Object (SCP)

Enterprise Imaging Move-SCP will accept any number of Move Presentation Contexts per association request. Any one Abstract Syntax may be specified more than once in an association request, if the Transfer Syntaxes differ between the Presentation Contexts.

2.2.1.6.7.5 Transfer Syntax Selection Policies – Move Object (SCP)

By default, Enterprise Imaging Move-SCP sends the IOD using the transfer syntax that was used when the image was originally stored. It will convert the IOD to a transfer syntax with native (uncompressed) pixel data (=Explicit or Implicit VR Little Endian) if the original transfer syntax is not supported by the destination.

Enterprise Imaging Move-SCP can be configured on a per-destination basis to convert the IOD from the original transfer syntax to Explicit or Implicit VR Little Endian.

2.3 Network Interfaces

Enterprise Imaging provides DICOM V3.0 TCP/IP Network Communication Support as defined in PS 3.8 of the DICOM Standard. Enterprise Imaging inherits its TCP/IP stack from the computer system upon which it executes.

2.3.1 Physical Medium Support

Enterprise Imaging is indifferent to the physical medium over which TCP/IP executes; it inherits the medium from the computer system upon which it is being executed.

2.4 Configuration

Any configuration of Enterprise Imaging that affects DICOM conformance is described in this section.

2.4.1 Core Server Configuration

Any Core Server Configuration that affects DICOM conformance is described in this section.

2.4.1.1 Core Server AE Title/Presentation Address Mapping

The translation from Application Entity Title to Presentation Address is stored in the database. Along with this mapping, the database stores those AE titles that are allowed to communicate with Core Server.

2.4.1.1.1 Core Server Local AE Titles

The local AE Titles and TCP ports are configurable through web interface.

2.4.1.1.2 Core Server Remote AE Title

Remote AE Titles, TCP/IP Addresses and ports can be configured through web interface.

2.4.1.2 Core Server Parameters

The following table shows the Core Server configuration parameters relevant to DICOM communication. Refer to the Core Server Documentation for details on general configuration capabilities.

Parameter	Configurable	Default Value
General Parameters		
PDU Size	Yes	16378 bytes
Time-out waiting for acceptance or rejection Response to an Association Open Request. (Application Level timeout)	Yes	10 s
General DIMSE level time-out values	Yes	600 s
Time-out waiting for response to TCP/IP connect request. (Low-level timeout)	No	None
Time-out waiting for acceptance of a TCP/IP message over the network. (Low-level timeout)	No	None
Time-out for waiting for data between TCP/IP packets. (Low-level timeout)	No	None
Any changes to default TCP/IP settings, such as configurable stack parameters.	No	None
Listening Port	Yes	104 (Non-Secure) 110 (guest cache) 2762 (Secure)
Maximum number of simultaneous Associations	Yes	See table 2.6
Time-out waiting for A-ASSOCIATE RQ on open TCP/IP connection (ARTIM timeout)	Yes	5s
Time-out waiting on an open association for the next message (DIMSE timeout)	Yes	600 s
Time-out waiting for acceptance or rejection Response to an Association Open Request. (Application Level timeout)	Yes	10 s
Time-out waiting on an open association for the next message after sending A-RELEASE RSP or A-ABORT RQ (Closing timeout)	Yes	50 ms
Pack Command and Data PDVs in one PDU	Yes	false

Parameter	Configurable	Default Value
Support for the Basic TLS Secure Transport Connection Profile	Yes	Off
Accepted TLS Ciphers	Yes	-
AE Specific Parameters (all AEs)		
Size constraint in maximum object size	No	None
Maximum PDU size the AE can receive	Yes	16352 bytes
Maximum PDU size the AE can send	No	1048576 bytes
AE specific DIMSE level time-out values	No	None
SOP Class support	No	All supported SOP Classes always proposed and accepted
Transfer Syntax support	No	All supported Transfer Syntaxes always proposed and accepted
Storage Server AE		
Accepted Called AE Titles ⁴¹	Yes	
Accepted Calling AE Titles	Yes	
List of DICOM AE Titles that identify the location from which composite object instance(s) received by this Storage Server may be retrieved on the network	Yes	
Storage Directory Path Prefix	Yes	
Time-out waiting for the A-ASSOCIATE-AC PDU after transmission of the A-ASSOCIATE-RQ to open an association to the Storage Commitment SCU	Yes	10 s
Query/Retrieve Server AE		
Accepted Called AE Titles	Yes	
Accepted Calling AE Titles	Yes	
Send optional C-MOVE RSPs with Pending Status to the C-MOVE SCU during the retrieve process	Yes	true
Time-out waiting for the A-ASSOCIATE-AC PDU after transmission of the A-ASSOCIATE-RQ to open an association to the Move Destination AE	Yes	10 s

⁴¹ The behavior of the Core Server depends on the AE title as one or multiple AE titles can be defined for different services.

3 MEDIA INTERCHANGE

3.1 Core Server

3.1.1 Implementation Model

3.1.1.1 Application Data Flow

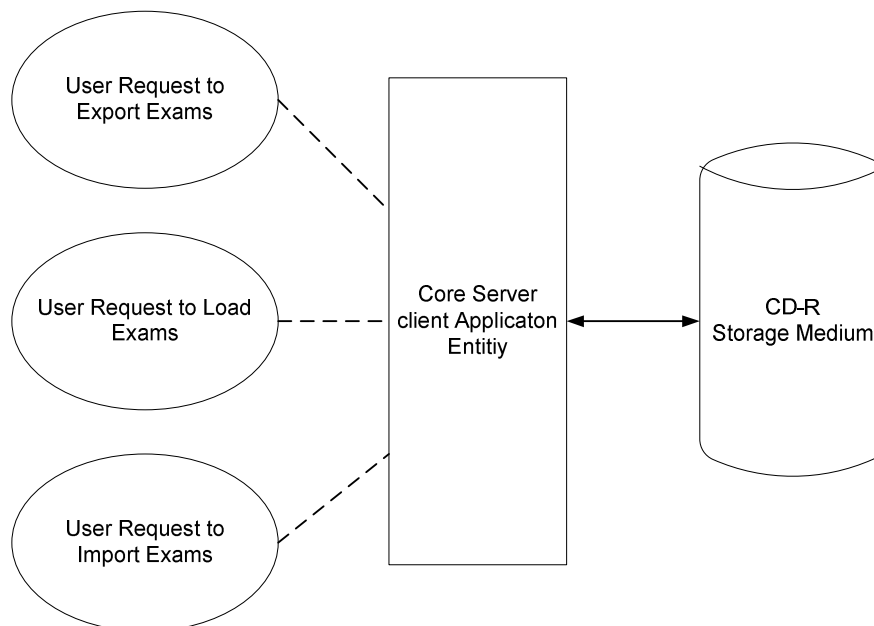

Figure 3-1: Application Data Flow Diagram for Interchange Media

The following data flows are depicted in the diagram:

- The Core Server Client Application Entity exports exams to CD-R storage medium. It is associated with the local real-world activity "Save to Media". A DICOM viewer is exported along with the exams. "Save to Media" is performed upon user request for selected patients, studies, series and instances (images, presentation states and other non-image objects).
- The Core Server Client Application Entity loads exams from the CD-R storage medium. It is associated with the local real-world activity "Open" Exams. It is performed upon user request to search the content of the CD-R storage medium and then open the selected studies to display corresponding patients, studies, series or instances (images, presentation states and other non-image objects).
- The Core Server Client Application Entity imports exams from the CD-R storage medium to its Storage-SCP AE. It is associated with the real-world activity "Import" Exams. It is performed upon user request to import selected studies with all containing patients, series or instances (images, presentation states and other non-image objects).

3.1.1.2 Functional Definitions of AE's

3.1.1.2.1 Functional Definition of Core Server Client Application Entity

Activation of the "Save to Media" with the selected method "Burn CD/DVD" will create an export job. Each export job has references to one or more studies selected by the user. The contents referenced in each export job will be written to a single CD-R media. The disk space check is performed before burning and the job will be blocked if the total size of the selection is larger than the capacity of a single CD-R media.

Selecting a CD/DVD as the search location will read the DICOMDIR (if available) or search for DICOM files on the media and present all the studies available on the CD/DVD to the user. The user can then select one or more studies to be displayed at the Core Server Client Application Entity.

Activation of the "Import" icon or menu entry will import the selected patients and studies to the internal PACS AE. Import is performed by transmitting the instances of the selected studies to the internal PACS AE.

3.1.1.3 Sequencing of Real-World Activities

3.1.1.3.1 Save to media

One or more studies must be selected before the "Save to Media" action can be invoked. An export job is created. The job contains references to which studies are selected. The Core Server Client AE retrieves all the instances for the referenced studies, transcodes them into DICOM files with Transfer Syntax Explicit VR Little Endian. A HTML representation of the studies including the images as jpg files is created. The Core Server Client AE then writes all the contents and a DICOM viewer is then stored to a CD-R storage medium if a blank media is available and inserted in the CD-R writer device, or the write process will wait until a blank media is available.

3.1.1.3.2 Importing from media

When the Core Server Client AE imports one or more studies from a CD-R media, the instances are loaded from the DICOM file folders. The transmission from Core Server Client Application to internal PACS AE is done via C-Store service as a Service Class User.

3.1.1.4 File Meta Information for Implementation Class and Version

Table 3-1: File Meta Information for Implementation Class and Version

File Meta Information Version	0x00 0x01
Implementation Class UID	1.2.40.0.13.1.1
Implementation Version Name	dcm4che-null

3.1.2 AE Specification

3.1.2.1 Core Server Client AE

Core Server Client AE provides standard conformance to DICOM Interchange Option of the Media Storage Device Class.

Table 3-2: AE Related Application Profiles, Real World Activities and Role

Application Profiles Supported	Real World Activity	Role	SC Option
STD-GEN-CD	Export Exams	FSC	Interchange
STD-GEN-CD	Load Exams	FSR	Interchange
STD-GEN-CD	Import Exams	FSR	Interchange

3.1.2.1.1 File Meta Information for the Core Server Client AE

3.1.2.1.2 Real World Activities

3.1.2.1.2.1 Activity – Export Exams

The Core Server Client AE acts as a File-Set Creator when export patient exams to an interchange media. It creates the DICOM Directory structure with references to the exam objects. If the content of the current selection exceeds the capacity of a single CD-R medium an error dialog will be shown notifying the user that export to this medium is not possible.

The user will be prompted to insert an empty CD-R for each export job. The contents of the export job will be written together with a corresponding DICOMDIR and a DICOM viewer to a single-session CDR. Writing in multi-session mode is not supported. The user can cancel an export job in the job queue.

3.1.2.1.2.1.1 Application Profile Specific Conformance

The Core Server Client AE supports the STD-GEN-CD Application Profile. It supports all SOP classes defined in Table 1-1. All exported instances have transfer syntax set to Explicit VR Little Endian (transfer syntax UID 1.2.840.10008.1.2.1). If an instance stored in the Core Server AE associated with the Core Server Client AE does not have transfer syntax of Explicit VR Little Endian, then the Core Server Client AE will convert the object into Explicit VR Little Endian.

The following attributes are defined as Type 1 for the DICOM directory record but are defined as Type 2 in the corresponding Information Object Definition:

- (0008,0020) Study Date
- (0008,0030) Study Time
- (0020,0010) Study ID
- (0020,0011) Series Number
- (0020,0013) Instance Number

If the values of these attributes are empty in the Core Server AE database, then the Core Server AE will not automatically generate a value for them. In other words, if one or more of these type 1 attributes are still empty after the updates from the database, the study will be exported as is and the media will not be DICOM Part 10 compliant in this case.

3.1.2.1.2.2 Activity – Load Exams

The Core Server Client AE also acts as a File-Set Reader when reading exams from an interchange media. It retrieves the references to the exam objects based on the DICOM Directory structure (if available) or search for DICOM files on the media and then presents a list of all the available exams to the user. Then the user can select a study and display the objects using the location references retrieved from the DICOM Directory structure.

3.1.2.1.2.2.1 Application Profile Specific Conformance

The Core Server Client AE supports the STD-GEN-CD Application Profile. It supports all SOP classes defined in Table 1-1 with transfer syntax set to Explicit VR Little Endian (transfer syntax UID 1.2.840.10008.1.2.1)

3.1.2.1.2.3 Activity – Import Exams

The Core Server Client AE also acts as a File-Set Reader when it imports exams from an interchange media to its associated Core Server AE. It retrieves the references to the exam objects based on the DICOM Directory structure. Then using the location references retrieved, it transmits the objects to its associated Core Server AE via DICOM C-Store.

3.1.2.1.2.3.1 Application Profile Specific Conformance

The Core Server Client AE supports the STD-GEN-CD Application Profile. It supports all SOP classes defined in Table 1-1 with transfer syntax set to Explicit VR Little Endian (transfer syntax UID 1.2.840.10008.1.2.1).

3.1.3 Augmented and Private Profiles

3.1.3.1 Augmented Profiles

None

3.1.3.2 Private Profiles

None

3.1.4 Media Configuration

None

3.2 Web Server

3.2.1 Implementation Model

3.2.1.1 Application Data Flow Diagram

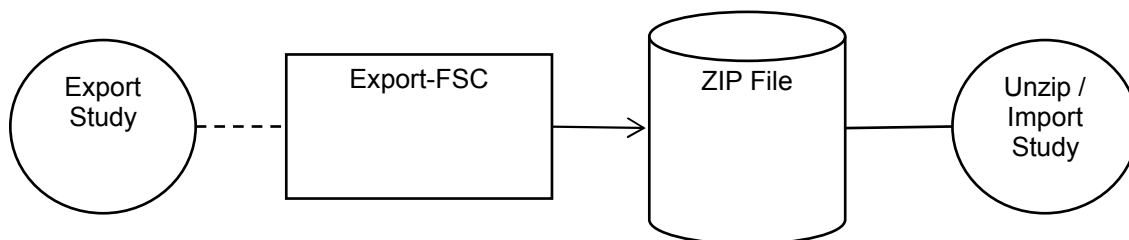

Figure 3.2-1: Application Data Flow Diagram

Web Server supports export of a study to a ZIP archive following the data model in DICOM part 10, on behalf of a user request. The resulting archive may be extracted by the user, and then imported by a device that is compliant with DICOM part 10.

3.2.1.2 Functional Definition of AEs

3.2.1.2.1 Export-FSC

Export-FSC is activated through the user interface to export a given study. It organizes the SOP Instances according to DICOM part 10, including the creation of a DICOMDIR entry. These files are then provided as a single ZIP file. The user has the option to encrypt the ZIP file with a given password.

3.2.1.3 Sequencing of Real World Activities

Not applicable

3.2.1.4 File Meta Information for Implementation Class and Version

Attribute Name	Tag	Type	Value
File Meta Information Version	(0002,0001)	1	00\01
Implementation Class UID	(0002,0012)	1	<i>Not set or modified</i>
Implementation Version Name	(0002,0013)	3	<i>Not set or modified</i>

The Implementation Class UID and Implementation Version Name attributes are not set or modified by the Export-FSC. If they contain a value, then it will originate from the image manager from which Web Server retrieved the SOP instance.

3.2.2 AE Specifications

3.2.2.1 Export-FSC Specification

Export-FSC provides standard conformance to the Media Storage Service Class.

Table 3.2-1: Application Profiles, Real World Activities and Roles for Export-FSC

Supported Application Profile	Real-World Activity	Roles	SC Option
STD-GEN-ZIP-MAIL	Export Study	FSC	
STD-GEN-SEC-ZIP-MAIL	Export Study	FSC	

Export-FSC does not provide a native E-Mail service, but relies on the end-user to attach the ZIP File provided in an E-Mail to the intended destination.

3.2.2.1.1 File Meta Information for the Export-FSC

No file meta information is set or modified by the Export-FSC.

3.2.2.1.2 Real World Activities

3.2.2.1.2.1 Real World Activity – Export Study

The Export-FSC is activated through the Web Server user interface. Once a study is in view, the end-user may have the option, depending on their permissions and configuration, to export the study to a ZIP. Upon selecting this option, the user is then presented with the further option of encrypting the ZIP with a user-supplied password. Once acknowledged, Web Server will activate the Export-FSC to construct the ZIP file containing all of the SOP instances of the study, including the generation of a DICOMDIR. The ZIP file is then presented to the user for download, and the user may email the ZIP to its destination or unzip and import directly into another device.

3.2.2.1.2.1.1 Media Storage Application Profile

The Export-FSC uses the STD-GEN-ZIP-MAIL and STD-GEN-SEC-ZIP-MAIL profiles.

3.2.2.1.2.1.1.1 Options

Not applicable

3.2.3 Augmented and Private Application Profiles

3.2.3.1 Augmented Application Profiles

3.2.3.1.1 Augmented Application Profile – STD-GEN-ZIP-MAIL

3.2.3.1.1.1 SOP Class Augmentations

None

3.2.3.1.1.2 Directory Augmentations

None

3.2.3.1.1.3 Other Augmentations

The ZIP file may be encrypted at the user's discretion, with a user-supplied password.

3.2.3.1.2 Augmented Application Profile STD-GEN-SEC-ZIP-MAIL

3.2.3.1.2.1 SOP Class Augmentations

None

3.2.3.1.2.2 Directory Augmentations

None

3.2.3.1.2.3 Other Augmentations

The ZIP file may be encrypted at the user's discretion, with a user-supplied password.

3.2.3.2 Private Application Profiles

Not applicable

3.2.4 Media Configuration

Not applicable

4 SUPPORT FOR EXTENDED CHARACTER SETS

4.1 Core Server Support for Extended Character Sets

Core Server supports the following character sets:

Table 4-1: Enterprise Imaging Extended Character Sets

Defined Term	Character Set Description
ISO-IR 13	Japanese
ISO-IR 100 (Default)	Latin Alphabet No. 1
ISO-IR 101	Latin Alphabet No. 2
ISO-IR 109	Latin Alphabet No. 3
ISO-IR 110	Latin Alphabet No. 4
ISO-IR 126	Greek
ISO-IR 127	Arabic
ISO-IR 138	Hebrew
ISO-IR 144	Cyrillic
ISO-IR 148	Latin Alphabet No. 5
ISO-IR 166	Thai
ISO-IR 192	Unicode in UTF-8
ISO 2022-IR 6	ISO 646
ISO 2022-IR 13	Japanese
ISO 2022-IR 87	Japanese (Supplementary Kanji Set)
ISO 2022-IR 100	Latin Alphabet No. 1
ISO 2022-IR 101	Latin Alphabet No. 2
ISO 2022-IR 109	Latin Alphabet No. 3
ISO 2022-IR 110	Latin Alphabet No. 4
ISO 2022-IR 126	Greek
ISO 2022-IR 127	Arabic
ISO 2022-IR 138	Hebrew
ISO 2022-IR 144	Cyrillic
ISO 2022-IR 148	Latin Alphabet No. 5
ISO 2022-IR 149	Korean
ISO 2022-IR 159	Japanese
ISO 2022-IR 166	Thai
GB18030	Chinese

5 SECURITY

5.1 Security Profiles

Enterprise Imaging supports secure DICOM communication in conformance with the Basic TLS Secure Transport Connection Profile. At default configuration, the TLS option is deactivated.

5.2 Association Level Security

Enterprise Imaging provides association level security by restricting acceptance to association requests only from DICOM AEs configured in Enterprise Imaging.

Association requests from unknown DICOM AEs will be rejected.

5.3 Application Level Security

Enterprise Imaging Administration Tools require a valid user name and password pair to login.

Core Server and Web Server User Interfaces require user authentication in order to access user interface functionality.

Activities are logged according to the IHE Audit Trail and Node Authentication (ATNA) Profile.

6 SUPPORT FOR DICOMweb SERVICES

Note:

Support for some RESTful DICOMweb services are experimental in version 8.1.x and may require assistance. Please contact your Agfa representative to discuss with Product Management for further details.

6.1 Scope

This chapter describes the family of DICOMweb services defined for sending, retrieving and querying for medical images and related information.

The family consists of:

1. QIDO-RS (Query based on ID for DICOM Objects);
2. WADO-RS (Web Access of DICOM Objects);
3. WADO-URI;
4. STOW-RS (Store over the web);
5. CAPABILITIES Service.

6.2 Use Cases

Table 6-1: Use Cases

Use Case	Description
QUERY Service	Users (e.g. for a particular patient) can look up studies, series in a study, series, instances for a study or series, instances by study and instances.
RETRIEVE Service	Users can retrieve an individual study, series, instances, frames, meta-data or bulk data items.
STORE Service	Users can store specific instances to the server.
CAPABILITIES Service	Users can discover the supported services by the server.

6.3 QIDO-RS

Note:

Support for some RESTful DICOMweb services are experimental in version 8.1.x and may require assistance. Please contact your Agfa representative to discuss with Product Management for further details.

QIDO is implemented in the core server platform as RESTful Service. Coupled with the query service, it provides a reliable method of querying for DICOM data over the web.

The user through an HTTP:GET request can search for studies, series or instances. The user shall specify the target resource as part of the URI and the acceptable response Content-Type in the HTTP Header (i.e. dicom+XML or dicom+JSON).

The URI is composed by a base URI = http://server_ip:8080/dicom-web/{AETitle} and the target resource path. Each resource path triggers a server action.

Table 6-2: QIDO Resource Paths

Action	Resource Path
Search for Studies	/studies
Search for Series	/series
Search for Instances	/instances
Search for Series Of Study	/studies/{StudyInstanceUID}/series
Search for Instances Of Study	/studies/{StudyInstanceUID}/instances
Search for Instances Of Series	/studies/{StudyInstanceUID}/series/{SeriesInstanceUID}/instances

QIDO queries support options added by query parameters.

Table 6-3: QIDO Query Parameters

Query Parameter	Data Type	Description
{attributeID}={value},...	String[]	Attribute values to address the search
includefield={attributeID},...	String[]	Attributes to be included in the response
fuzzymatching	Boolean	Enable fuzzy semantics search
limit	Int	Maximum number of results the server shall return
offset	Int	Number of results the server shall skip before the first returned result
orderby	String[]	Order the response by specified attributes
datetimematching	Boolean	Date-time matching
timezoneadjustment	Boolean	Time zone adjustment

Queries can be performed at study, series and instance level for both relational (not following the DICOM hierarchy) and hierarchical models. It is transparent for the customer which model is used and it is applied implicitly based on the query requested.

6.4 WADO-RS and WADO-URI

WADO has got two different implementations in the core server platform, Wado-RS and Wado-URI. Coupled with the retrieve service, they provide a reliable method of retrieving specific DICOM data over the web.

6.4.1 WADO-RS

Note:

Support for some RESTful DICOMweb services are experimental in version 8.1.x and may require assistance. Please contact your Agfa representative to discuss with Product Management for further details.

The user through an HTTP: GET request can retrieve specific studies, series or instances. The user shall specify the target resource as part of the URI and the acceptable response Content-Type in the HTTP Header (i.e. ZIP, dicom, dicom+XML, dicom+JSON, octet-stream, compressed pixel data).

The URI is composed by a base URI = http://server_ip:8080/dicom-web/{AETitle} and the target resource path. Each resource path triggers a server action.

Table 6-4: WADO-RS Resource Paths

Action	Resource Path
Retrieve Study	/studies/{StudyInstanceUID}
Retrieve Series	/studies/{StudyInstanceUID}/series/{SeriesInstanceUID}
Retrieve Instance	/studies/{StudyInstanceUID}/series/{SeriesInstanceUID}/instances/{SOPInstanceUID}
Retrieve Frame	/studies/{StudyInstanceUID}/series/{SeriesInstanceUID}/instances/{SOPInstanceUID}/frames/{FrameList}
Retrieve Bulk data	/bulkdata/{BulkDataPath.*}
Retrieve Study Metadata	/studies/{StudyInstanceUID}/metadata
Retrieve Series Metadata	/studies/{StudyInstanceUID}/series/{SeriesInstanceUID}/metadata
Retrieve Instance Metadata	/studies/{StudyInstanceUID}/series/{SeriesInstanceUID}/instances/{SOPInstanceUID}/metadata

6.4.2 WADO-URI

The user through an HTTP: GET request can retrieve specific studies, series or instances. The user shall specify all the necessary information as part of the URI in form of query parameters.

The URI is composed by a base URI = http://server_ip:8080/dicom-web/{AETitle} and query parameters.

Table 6-5: WADO-URI Query Parameters

Query Parameter	Data Type	Description
requestType	String	Must be present and equal to "WADO"
studyUID	String	Study Instance ID must be present
seriesUID	String	Series Instance ID must be present
objectUID	String	Instance ID must be present
contentType	String	Must be compatible with the acceptable MediaTypes in the HTTP Header. The WADO-URI service supports Rendered Media Types or the uri-media-type (see Section 6.1.1.3 and 6.1.1.8.5 in DICOM PS3.18 2016d).
charset	String	Not used.
anonymize	String	Not used. If MediaType different from application/dicom it must be not specified.
annotation	String	Not used. If MediaType equal to application/dicom it must be not specified.
rows	Int	Used to render image output. If MediaType equal to application/dicom it must be equal to 0. If MediaType different from application/dicom it must be greater or equal than 0.
columns	Int	Used to render image output. If MediaType equal to application/dicom it must be equal to 0.

Query Parameter	Data Type	Description
		If MediaType different from application/dicom it must be greater or equal than 0.
region	String	Not used. If MediaType equal to application/dicom it must be not specified.
windowCenter	Float	Used to render image output. If MediaType equal to application/dicom it must be equal to 0.
windowWidth	Float	Used to render image output. If MediaType equal to application/dicom it must be equal to 0.
frameNumber	Int	Used to render image output. If MediaType equal to application/dicom it must be equal to 0.
imageQuality	Int	Used to render image output. If MediaType equal to application/dicom it must be equal to 0. If MediaType different from application/dicom it must be between 1 and 100.
presentationUID and presentationSeriesUID	String	Used to render image output. If MediaType equal to application/dicom they must be not specified. If MediaType different from application/dicom, if presentationUID specified then presentationSeriesUID must be present.
transferSyntax	String[]	If MediaType different from application/dicom it must be empty.
overlays	Boolean	If true sets overlay activation mask

6.5 STOW-RS

Note:

Support for some RESTful DICOMweb services are experimental in version 8.1.x and may require assistance. Please contact your Agfa representative to discuss with Product Management for further details.

STOW is implemented in the core server platform as RESTful Service. Coupled with the store service, it provides a reliable method of storing specific instances to the server over the web.

The users through an HTTP: POST request can store or append to an existing resources on the server specific instances. The user shall specify the target resource as part of the URI and encapsulate the data in a multipart request body with a proper Content-Type (i.e. BINARY, XML or JSON).

The URI is composed by a base URI = http://server_ip:8080/dicom-web/{AETitle} and the target resource path. Each resource path triggers a server action.

Table 6-6: STOW-RS Resource Paths

Action	Resource Path
Store Instances from multiple studies	/studies
Store Instances for a single study	/studies/{StudyInstanceUID}

6.6 CAPABILITIES Service

Note:

Support for some RESTful DICOMweb services are experimental in version 8.1.x and may require assistance. Please contact your Agfa representative to discuss with Product Management for further details.

CAPABILITIES service is used to retrieve the parameters for services supported by the application.

The Capabilities service is implemented in the core server platform as RESTful Service.

The user through an HTTP: OPTIONS request can discover the supported services by the server.

The user shall specify the target resource as part of the URI and the acceptable response Content-Type in the HTTP Header (i.e. Web Application Description Language (WADL) or JSON).

The URI is composed by a base URI = http://server_ip:8080/dicom-web/{AETitle} and the target resource path. Each resource path triggers a server action.

Table 6-7: CAPABILITIES Service Resource Paths

Action	Resource Path
Retrieve Application Description	/
Retrieve Resource Description	/{path: .+} Path to a defined DICOM RESTful service resource, such as QIDO, WADO and STOW.

7 ANNEXES

7.1 IOD Contents

7.1.1 Created SOP Instance

Core Server creates GSPS as PR modality and Key Object Selection Document as KO modality.

Web Server creates DOC (RAW Data), AU, SR or ECG (Encapsulated PDF), encapsulated CDA, GSPS (as of version 8.1.4), Key Object document and XC as XC modality.

The following tables use a number of abbreviations. The abbreviations used in the “Presence of Module” and “Presence of Value” columns are:

ALWAYS	Always Present with a value
ANAP	Attribute Not Always Present
EMPTY	Attribute is sent without a value
VNAP	Value Not Always Present (attribute sent zero length if no value is present)

The abbreviations used for the source of the data values in the tables are:

AUTO	The attribute value is generated automatically
CONFIG	The attribute value source is a configurable parameter
MPPS	The attribute value source is Modality Performed Procedure Step
MWL	The attribute value source is Modality Worklist
USER	The attribute value source is from user input

7.1.2 Core Server

7.1.2.1 GSPS IOD

Table 7-1: IOD of GSPS SOP Instances

IE	Module	Reference	Presence of Module
Patient	Patient	Table 7-3	ALWAYS
Study	General Study	Table 7-4	ALWAYS
	Patient Study	Table 7-5	ALWAYS
Series	General Series	Table 7-6	ALWAYS
	Presentation Series	Table 7-9	ALWAYS
Equipment	General Equipment	Table 7-7	ALWAYS
Presentation State	Presentation State Identification	Table 7-10	ALWAYS
	Displayed Area	Table 7-11	ALWAYS
	Graphic Annotation	Table 7-12	Required if Graphic Annotations are to be applied to referenced image(s)
	Spatial Transformation	Table 7-13	Required if rotation or flipping are to be applied to referenced image(s)
	Graphic Layer	Table 7-14	Required if Graphic Annotations or Overlays or Curves are to be applied to referenced image(s)
	Softcopy VOI LUT	Table 7-15	Required if a VOI LUT is to be applied to referenced image(s)
	Softcopy Presentation LUT	Table 7-16	ALWAYS
SOP Common	Table 7-8	ALWAYS	

7.1.2.2 Key Object Selection Document IOD

Table 7-2: IOD of KO SOP Instances

IE	Module	Reference	Presence of Module
Patient	Patient	Table 7-3	ALWAYS
Study	General Study	Table 7-4	ALWAYS
	Patient Study	Table 7-5	ALWAYS
Series	General Series	Table 7-6	ALWAYS
Equipment	General Equipment	Table 7-7	ALWAYS
Document	Key Object Document	Table 7-17	ALWAYS
	Document Content	Table 7-18	ALWAYS
	SOP Common	Table 7-8	ALWAYS

7.1.2.3 Common Modules

Table 7-3: Patient Module of Created SOP Instances

Attribute Name	Tag	VR	Value	Presence of Value	Source
Patient's Name	(0010,0010)	PN	Obtained directly from referenced image	ALWAYS	AUTO
Patient ID	(0010,0020)	LO	Obtained directly from referenced image	ALWAYS	AUTO
Issuer of Patient ID	(0010,0021)	LO	Obtained directly from referenced image	VNAP	AUTO
Issuer of Patient ID Qualifiers Sequence ⁴²	(0010,0024)	SQ	Obtained directly from referenced image	VNAP	AUTO
>Universal Entity ID	(0040,0032)	UT	Obtained directly from referenced image	VNAP	AUTO
>Universal Entity ID Type	(0040,0033)	CS	Obtained directly from referenced image	VNAP	AUTO
Patient's Birth Date	(0010,0030)	DA	Obtained directly from referenced image	VNAP	AUTO
Patient's Sex	(0010,0040)	CS	Obtained directly from referenced image	VNAP	AUTO
Other Patient IDs	(0010,1000)	LO	Obtained directly from referenced image	VNAP	AUTO
Other Patient Names	(0010,1001)	PN	Obtained directly from referenced image	ANAP	AUTO
Other Patient IDs Sequence	(0010,1002)	SQ	Obtained directly from referenced image	VNAP	AUTO
> Patient ID	(0010,0020)	LO	Obtained directly from referenced image	VNAP	AUTO
> Issuer of Patient ID	(0010,0021)	LO	Obtained directly from referenced image	VNAP	AUTO
>Type of Patient ID ⁴³	(0010,0022)	CS	Obtained directly from referenced image	VNAP	AUTO
> Issuer of Patient ID Qualifiers Sequence	(0010,0024)	SQ	Obtained directly from referenced image	VNAP	AUTO
>>Universal Entity ID ⁴²	(0040,0032)	UT	Obtained directly from referenced image	VNAP	AUTO
>>Universal Entity ID Type ⁴²	(0040,0033)	CS	Obtained directly from referenced image	VNAP	AUTO
>>Identifier Type Code	(0040,0035)	CS	Obtained directly from referenced image	VNAP	AUTO
Ethnic Group	(0010,2160)	SH	Obtained directly from referenced image	VNAP	AUTO
Patient Comments	(0010,4000)	LT	Obtained directly from referenced image	VNAP	AUTO

Table 7-4: General Study Module of Created SOP Instances

⁴² Available as of EI 8.1.4

⁴³ Available as of EI 8.1.3

Attribute Name	Tag	VR	Value	Presence of Value	Source
Study Instance UID	(0020,000D)	UI	Obtained directly from referenced image	ALWAYS	AUTO
Study Date	(0008,0020)	DA	Obtained directly from referenced image	ALWAYS	AUTO
Study Time	(0008,0030)	TM	Obtained directly from referenced image	ALWAYS	AUTO
Referring Physician's Name	(0008,0090)	PN	Obtained directly from referenced image	VNAP	AUTO
Study ID	(0020,0010)	SH	Obtained directly from referenced image	VNAP	AUTO
Accession Number	(0008,0050)	SH	Obtained directly from referenced image	VNAP	AUTO
Study Description	(0008,1030)	LO	Obtained directly from referenced image	ANAP	AUTO

Table 7-5: Patient Study Module of Created SOP Instances

Attribute Name	Tag	VR	Value	Presence of Value	Source
Patient's Age	(0010,1010)	AS	Obtained directly from referenced image	ANAP	AUTO
Patient's Size	(0010,1020)	DS	Obtained directly from referenced image	ANAP	AUTO
Patient's Weight	(0010,1030)	DS	Obtained directly from referenced image	ANAP	AUTO

Table 7-6: General Series Module of Created SOP Instances

Attribute Name	Tag	VR	Value	Presence of Value	Source
Modality	(0008,0060)	CS	PR for Presentation States KO for key images notes	ALWAYS	AUTO
Series Instance UID	(0020,000E)	UI	Generated by application	ALWAYS	AUTO
Series Number	(0020,0011)	IS	Generated by application	ALWAYS	AUTO
Series Date	(0008,0021)	DA	<yyyymmdd>	ANAP	AUTO
Series Time	(0008,0031)	TM	<hhmmss>	ANAP	AUTO
Series Description	(0008,103E)	LO	PR: EMPTY KO: Attribute not present	ANAP	PS: USER
Referenced Performed Procedure Step Sequence	(0008,1111)	SQ	Obtained directly from referenced image	ANAP	AUTO
>Referenced SOP Class UID	(0008,1150)	UI	Obtained directly from referenced image	ANAP	AUTO
>Referenced SOP Instance UID	(0008,1155)	UI	Obtained directly from referenced image	ANAP	AUTO
Body Part Examined	(0018,0015)	CS	Obtained directly from referenced image	ANAP	AUTO

Table 7-7: General Equipment Module of Created SOP Instances

Attribute Name	Tag	VR	Value	Presence of Value	Source
Manufacturer	(0008,0070)	LO	KO: empty PR: AGFA	VNAP	AUTO

Table 7-8: SOP Common Module of Created SOP Instances

Attribute Name	Tag	VR	Value	Presence of Value	Source
----------------	-----	----	-------	-------------------	--------

Attribute Name	Tag	VR	Value	Presence of Value	Source
SOP Class UID	(0008,0016)	UI	Presentation State = 1.2.840.10008.5.1.4.1.1.11.1 Key Image Notes = 1.2.840.10008.5.1.4.1.1.88.59	ALWAYS	AUTO
SOP Instance UID	(0008,0018)	UI	Created by application	ALWAYS	AUTO
Specific Character Set	(0008,0005)	CS	Supported Character Sets listed in Chapter 4	ALWAYS	CONFIG
Instance Creation Date	(0008,0012)	DA	KO: <yyyymmdd>	ANAP	AUTO
Instance Creation Time	(0008,0013)	TM	KO: <hhmmss>	ANAP	AUTO
Instance Number	(0020,0013)	IS	Created by application	ALWAYS	AUTO

7.1.2.4 GSPS Modules

Table 7-9: Presentation Series Module of Created GSPS SOP Instances

Attribute Name	Tag	VR	Value	Presence of Value	Source
Modality	(0008,0060)	CS	PR	ALWAYS	AUTO
Softcopy VOI LUT Sequence	(0028,3110)	SQ	One or more items	VNAP	AUTO
>Referenced Image Sequence	(0008,1140)	SQ	Obtained directly from referenced image	ALWAYS	AUTO
>>Referenced SOP Class UID	(0008,1150)	UI	From referenced image	ALWAYS	AUTO
>>Referenced SOP Instance UID	(0008,1155)	UI	From referenced image	ALWAYS	AUTO
>>Referenced Frame Number	(0008,1160)	IS	If referenced image is a multiframe image	ANAP	AUTO

Table 7-10: Presentation State Identification Module of Created SOP Instances

Attribute Name	Tag	VR	Value	Presence of Value	Source
Presentation Creation Date	(0070,0082)	DA	<yyyymmdd>	ALWAYS	AUTO
Presentation Creation Time	(0070,0083)	TM	<hhmmss>	ALWAYS	AUTO
Instance Number	(0020,0013)	IS	Generated by application	ALWAYS	AUTO
Presentation Label	(0070,0080)	CS	From user input	ALWAYS	USER
Presentation Description	(0070,0081)	LO	From user input	VNAP	USER
Presentation Creator's Name	(0070,0084)	PN	Generated by device according to currently active user	ALWAYS	AUTO
Referenced Series Sequence	(0008,1115)	SQ	One or more items	ALWAYS	AUTO
>Series Instance UID	(0020,000E)	UI	From referenced image	ALWAYS	AUTO
>Referenced Image Sequence	(0008,1140)	SQ	From referenced image	ALWAYS	AUTO
>>Referenced SOP Class UID	(0008,1150)	UI	From referenced image	ALWAYS	AUTO
>>Referenced SOP Instance UID	(0008,1155)	UI	From referenced image	ALWAYS	AUTO

Attribute Name	Tag	VR	Value	Presence of Value	Source
>>Referenced Frame Number	(0008,1160)	IS	If referenced image is a multiframe image	ANAP	AUTO
Shutter Presentation Value	(0018,1622)	US	Generated by device if shutter present	ANAP	AUTO

Table 7-11: Displayed Area Module of Created GSPS SOP Instances

Attribute Name	Tag	VR	Value	Presence of Value	Source
Displayed Area Selection Sequence	(0070,005A)	SQ	One or more items	ALWAYS	AUTO
>Referenced Image Sequence	(0008,1140)	SQ	One or more items	ALWAYS	AUTO
>>Referenced SOP Class UID	(0008,1150)	UI	Obtained directly from referenced image	ALWAYS	AUTO
>>Referenced SOP Instance UID	(0008,1155)	UI	Obtained directly from referenced image	ALWAYS	AUTO
>>Referenced Frame Number	(0008,1160)	IS	If referenced image is a multiframe image	VNAP	AUTO
>Displayed Area Top Left Hand Corner	(0070,0052)	SL	From current display setting	ALWAYS	AUTO
>Displayed Area Bottom Right Hand Corner	(0070,0053)	SL	From current display setting	ALWAYS	AUTO
>Presentation Size Mode	(0070,0100)	CS	From current display setting	ALWAYS	AUTO
>Presentation Pixel Spacing	(0070,0101)	DS	From current display setting	ANAP	AUTO
>Presentation Pixel Aspect Ratio	(0070,0102)	IS	From current display setting	ANAP	AUTO
>Presentation Pixel Magnification Ratio	(0070,0103)	FL	From current display setting	ANAP	AUTO

Table 7-12: Graphic Annotation Module of Created GSPS SOP Instances

Attribute Name	Tag	VR	Value	Presence of Value	Source
Graphic Annotation Sequence	(0070,0001)	SQ	One or more items	ANAP	AUTO
>Referenced Image Sequence	(0008,1140)	SQ	One or more items	ALWAYS	AUTO
>>Referenced SOP Class UID	(0008,1150)	UI	From referenced image	ALWAYS	AUTO
>>Referenced SOP Instance UID	(0008,1155)	UI	From referenced image	ALWAYS	AUTO
>>Referenced Frame Number	(0008,1160)	IS	If referenced image is a multiframe image	ANAP	AUTO
>Graphic Layer	(0070,0002)	CS	ROI	ALWAYS	AUTO
>Text Object Sequence	(0070,0008)	SQ	One or more Items	ANAP	AUTO

Attribute Name	Tag	VR	Value	Presence of Value	Source
>>Anchor Point Annotation Units	(0070,0004)	CS	PIXEL	ALWAYS	AUTO
>>Unformatted Text Value	(0070,0006)	ST	From user Input or automatic generated from graphic object properties	ALWAYS	AUTO or USER
>>Bounding Box Text Horizontal Justification	(0070,0012)	CS	Input from the user	ALWAYS	USER
>>Anchor Point	(0070,0014)	FL	Input from the user	ALWAYS	USER
>>Anchor Point Visibility	(0070,0015)	CS	Input from the user	ALWAYS	USER
>Graphic Object Sequence	(0070,0009)	SQ	One or more Items	ANAP	AUTO
>>Graphic Annotation Units	(0070,0005)	CS	PIXEL	ALWAYS	AUTO
>>Graphic Dimensions	(0070,0020)	US	2	ALWAYS	AUTO
>>Number of Graphic Points	(0070,0021)	US	Input from the user	ALWAYS	USER
>> Graphic Data	(0070,0022)	FL	Input from the user	ALWAYS	USER
>>Graphic Type	(0070,0023)	CS	CIRCLE, POLYLINE or INTERPOLATED	ALWAYS	USER
>>Graphic Filled	(0070,0024)	CS	Y or N	ALWAYS	USER

Table 7-13: Spatial Transformation Module of Created GSPS SOP Instances

Attribute Name	Tag	VR	Value	Presence of Value	Source
Image Rotation	(0070,0042)	US	From current display setting	ALWAYS	AUTO
Image Horizontal Flip	(0070,0041)	CS	From current display setting	ALWAYS	AUTO

Table 7-14: Graphic Layer Module of Created GSPS SOP Instances

Attribute Name	Tag	VR	Value	Presence of Value	Source
Graphic Layer Sequence	(0070,0060)	SQ	One or more items	ANAP	AUTO
>Graphic Layer	(0070,0002)	CS	ROI	ALWAYS	AUTO
>Graphic Layer Order	(0070,0062)	IS	From current display setting	ALWAYS	AUTO
>Graphic Layer Recommended Display Grayscale Value	(0070,0066)	US	<xxxxx> From 0000H(black) to FFFFH(white)	ANAP	AUTO
>Graphic Layer Recommended Display CIELab Value	(0070,0401)	US	<xxxxx\xxxxx\xxxxx> From 0000H(black) to FFFFH(white)	ANAP	AUTO

Table 7-15: Softcopy VOI LUT Module of Created GSPS SOP Instances

Attribute Name	Tag	VR	Value	Presence of Value	Source
Softcopy VOI LUT Sequence	(0028,3110)	SQ	One or more items	ALWAYS	AUTO

Attribute Name	Tag	VR	Value	Presence of Value	Source
>Referenced Image Sequence	(0008,1140)	SQ	One or more items	ALWAYS	AUTO
>>Referenced SOP Class UID	(0008,1150)	UI	From referenced image	ALWAYS	AUTO
>>Referenced SOP Instance UID	(0008,1155)	UI	From referenced image	ALWAYS	AUTO
>>Referenced Frame Number	(0008,1160)	IS	If referenced image is a multiframe image	ANAP	AUTO
>Window Center	(0028,1050)	DS	From current display setting	ALWAYS	AUTO
>Window Width	(0028,1051)	DS	From current display setting	ALWAYS	AUTO
> WindowCenter WidthExplanation	(0028,1055)	LO	From current display settings	ALWAYS	AUTO
VOI LUT Sequence	(0028,3010)	SQ	One or more Items	ANAP	AUTO
>LUT Descriptor	(0028,3002)	US/SS	From current display settings	ANAP	AUTO
>LUT Data	(0028,3006)	OW	From current display settings	ANAP	AUTO

Table 7-16: Softcopy Presentation LUT Module of Created GSPS SOP Instances

Attribute Name	Tag	VR	Value	Presence of Value	Source
Presentation LUT Shape	(2050,0020)	CS	INVERSE, IDENTITY	ALWAYS	AUTO

7.1.2.5 Flags and Sessions Modules

Table 7-17: Key Object Document Module Key Image Note SOP Instances

Attribute Name	Tag	VR	Value	Presence of Value	Source
Instance Number	(0020,0013)	IS	Generated by application	ALWAYS	AUTO
Content Date	(0008,0023)	DA	<yyyymmdd>	ANAP	AUTO
Content Time	(0008,0033)	TM	<hhmmss>	ANAP	AUTO
Current Requested Procedure Evidence Sequence	(0040,A375)	SQ	One or more items	ALWAYS	AUTO
>Study Instance UID	(0020,000D)	UI	Obtained from referenced image/s	ALWAYS	AUTO
>Referenced Series Sequence	(0008,1115)	SQ	One or more items	ALWAYS	AUTO
>>Series Instance UID	(0020,000E)	UI	Obtained from referenced image/s	ALWAYS	AUTO
>>Referenced SOP Sequence	(0008,1199)	SQ	One or more items	ALWAYS	AUTO
>>>Referenced SOP Class UID	(0008,1150)	UI	Obtained from referenced image/s	ALWAYS	AUTO
>>>Referenced SOP Instance UID	(0008,1155)	UI	Obtained from referenced image/s	ALWAYS	AUTO

Table 7-18 : Key Object Document Content Module of Created Sessions and Flags SOP Instances

Attribute Name	Tag	VR	Value	Presence of Value	Source
Specific Character Set	(0008,0005)	CS	Generated by Application	ALWAYS	AUTO
Instance Number	(0020,0013)	IS	Generated by application	ALWAYS	AUTO
Content Date	(0008,0023)	DA	<yyyymmdd>	ANAP	AUTO
Content Time	(0008,0033)	TM	<hhmmss>	ANAP	AUTO
Concept Name Code Sequence	(0040,A043)	SQ	One or more Items	ALWAYS	AUTO
> Code Value	(0008,0100)	SH	Generated by Application	ALWAYS	AUTO
>Coding Scheme Designator	(0008,0102)	SH	Generated by Application	ALWAYS	AUTO
>Code Meaning	(0008,0104)	LO	For Sessions : Key Object Description	ANAP	AUTO
Content Sequence	(0040,A730)	SQ	Some Items	ALWAYS	AUTO
>Relationship Type	(0040,A010)	CS	CONTAINS	ALWAYS	AUTO
>Value Type	(0040,A040)	CS	TEXT or IMAGE	ALWAYS	AUTO
>Referenced SOP Sequence	(0008,1199)	SQ	Two or more items	ALWAYS	AUTO
>Referenced SOP Class UID	(0008,1150)	UI	Obtained from referenced image/s	ALWAYS	AUTO
>Referenced SOP Instance UID	(0008,1155)	UI	Obtained from referenced image/s	ALWAYS	AUTO

7.1.3 Web Server

The abbreviations used for the 'Usage'-column in the tables are:

- Always – included with the full set of values.
- Never – not included
- Auto – included with pre-defined, automatically filled values.

7.1.3.1 XC – VL Photographic Image IOD

Table 7-19: IOD of XC – VL Photographic Image SOP Instances

IE	Module	Reference (DICOM part03)	Usage
Patient	Patient	C.7.1.1	Always
	Clinical Trial Subject	C.7.1.3	Never
Study	General Study	C.7.2.1	Always
	Patient Study	C.7.2.2	Never
	Clinical Trial Study	C.7.2.3	Never
Equipment	General Equipment	C.7.5.1	Auto
Image	General Image	C.7.6.1	Auto
	Image Pixel	C.7.6.3	Always
	Acquisition Context	C.7.6.14	Auto
	Device	C.7.6.12	Never
	Specimen	C.7.6.22	Never
	VL Image	C.8.12.1	Auto
	Overlay Plane	C.9.2	Never
	ICC Profile	C.11.15	Never
	SOP Common	C.12.1	Auto

7.1.3.2 XC – Video Photographic Image IOD

Table 7-20: IOD of XC - Video Photographic Image SOP Instances

IE	Module	Reference (DICOM part03)	Usage
Patient	Patient	C.7.1.1	Always
	Clinical Trial Subject	C.7.1.3	Never
Study	General Study	C.7.2.1	Always
	Patient Study	C.7.2.2	Never
	Clinical Trial Study	C.7.2.3	Never
Equipment	General Equipment	C.7.5.1	Auto
Image	General Image	C.7.6.1	Auto
	Cine	C.7.6.5	Always
	Multi-frame	C.7.6.6	Always
	Image Pixel	C.7.6.3	Always
	Acquisition Context	C.7.6.14	Auto
	Specimen	C.7.6.22	Never
	VL Image	C.8.12.1	Auto
	Device	C.7.6.12	Never
	ICC Profile	C.11.15	Never
	SOP Common	C.12.1	Auto

7.1.3.3 SR or ECG – Encapsulated PDF

Table 7-21: IOD of SR or ECG – Encapsulated PDF SOP Instances

IE	Module	Reference (DICOM part03)	Usage
Patient	Patient	C.7.1.1	Always
	Clinical Trial Subject	C.7.1.3	Never
Study	General Study	C.7.2.1	Always
	Patient Study	C.7.2.2	Never
	Clinical Trial Study	C.7.2.3	Never
Series	Encapsulated Document Series	C.24.1	Always
Equipment	General Equipment	C.7.5.1	Auto
Encapsulated Document	Encapsulated Document	C.24.2	Always
	SOP Common	C.12.1	Auto

7.1.3.4 AU – General Audio Waveform

Table 7-22: IOD of General Audio Waveform SOP Instances

IE	Module	Reference (DICOM part03)	Usage
Patient	Patient	C.7.1.1	Always
	Clinical Trial Subject	C.7.1.3	Never
Study	General Study	C.7.2.1	Always
	Patient Study	C.7.2.2	Never
	Clinical Trial Study	C.7.2.3	Never
Series	General Series	C.7.3.1	Always
	Clinical Trial Series	C.7.3.2	Never
Equipment	General Equipment	C.7.5.1	Auto
Waveform	Waveform Identification	C.10.8	Auto

IE	Module	Reference (DICOM part03)	Usage
	Waveform	C.10.9	Always
	Acquisition Context	C.7.6.14	Auto
	Waveform Annotation	C.10.10	Never
	SOP Common	C.12.1	Auto

7.1.3.5 DOC – RAW Data (Encapsulated)

This SOP Class is used for storing RAW Data. The specification specifies that private tags are required to store the data. In this case, the data is simply stored as an encapsulated any document type (except PDF/CDA, stored by itself) rather than creating new tags. The Modality is always DOC.

This type can be retrieved from the data services, and will default to the content type in the document itself.

Table 7-23: IOD of DOC – RAW Data (Encapsulated) SOP Instances

IE	Module	Reference (DICOM part03)	Usage
Patient	Patient	C.7.1.1	Always
	Clinical Trial Subject	C.7.1.3	Never
Study	General Study	C.7.2.1	Always
	Patient Study	C.7.2.2	Never
	Clinical Trial Study	C.7.2.3	Never
Series	Encapsulated Document Series	C.24.1	Always
Equipment	General Equipment	C.7.5.1	Auto
Encapsulated Document	Encapsulated Document	C.24.2	Always
	SOP Common	C.12.1	Auto

7.1.3.6 Encapsulated CDA IOD

Table 7-24: IOD of Encapsulated CDA SOP Instances

IE	Module	Reference (DICOM part03)	Usage
Patient	Patient	C.7.1.1	Always
	Clinical Trial Subject	C.7.1.3	Never
Study	General Study	C.7.2.1	Always
	Patient Study	C.7.2.2	Never
	Clinical Trial Study	C.7.2.3	Never
Series	Encapsulated Document Series	C.24.1	Always
	Clinical Trial Series	C.7.3.2	Never
Equipment	General Equipment	C.7.5.1	Auto
	SC Equipment	C.8.6.1	Auto
Encapsulated Document	Encapsulated Document	C.24.2	Always
	SOP Common	C.12.1	Auto

7.1.3.7 Grayscale Softcopy Presentation State (GSPS) IOD

Table 7-25: IOD of GSPS SOP Instances

IE	Module	Reference (DICOM part03)	Usage
Patient	Patient	C.7.1.1	Always

IE	Module	Reference (DICOM part03)	Usage
	Clinical Trial Subject	C.7.1.3	Never
Study	General Study	C.7.2.1	Always
	Patient Study	C.7.2.2	Never
	Clinical Trial Study	C.7.2.3	Never
Series	General Series	C.7.3.1	Always
	Clinical Trial Series	C.7.3.2	Never
	Presentation Series	C.11.9	Always
Equipment	General Equipment	C.7.5.1	Auto
Presentation State	Presentation State Identification	C.11.10	Always
	Presentation State Relationship	C.11.11	Always
	Presentation State Shutter	C.11.12	Always
	Presentation State Mask	C.11.13	Always
	Mask	C7.6.10	Required if the referenced image(s) are multi-frame and are to be subtracted
	Display Shutter	C.7.6.11	Required if a Display Shutter is to be applied to referenced image(s) and the Bitmap Display Shutter Module is not present
	Bitmap Display Shutter	C.7.6.15	Required if a Display Shutter is to be applied to referenced image(s) and the Display Shutter Module is not present
	Overlay Plane	C.9.2	Required if Overlay is to be applied to referenced image(s) or the Bitmap Display Shutter Module is present
	Overlay Activation	C.11.7	Required if referenced image contains overlay data that is to be displayed or Presentation State Instance contains Overlay data other than Bitmap Shutter
	Displayed area	C.10.4	Auto
Graphic Annotation	C.10.5	Required if Graphic Annotations are to be applied to referenced image(s)	
Spatial Transformation	C.10.6	Required if rotation or flipping are to be applied to	

IE	Module	Reference (DICOM part03)	Usage
			referenced image(s)
	Graphic Layer	C.10.7	Required if Graphic Annotations or Overlays or Curves are to be applied to referenced image(s)
	Graphic Group	C.10.11	Never
	Modality LUT	C.11.1	Required if a Modality LUT is to be applied to referenced image(s)
	Softcopy VOI LUT	C.11.8	Required if a VOI LUT is to be applied to referenced image(s)
	Softcopy Presentation LUT	C.11.6	Auto
	SOP Common	C.12.1	Auto

7.1.3.8 Key Object Selection Document IOD

Table 7-26: IOD of Key Object Selection Document SOP Instances

IE	Module	Reference (DICOM part03)	Usage
Patient	Patient	C.7.1.1	Always
	Clinical Trial Subject	C.7.1.3	Never
Study	General Study	C.7.2.1	Always
	Patient Study	C.7.2.2	Never
	Clinical Trial Study	C.7.2.3	Never
Series	Key Object Document Series	C.17.6.1	Always
	Clinical Trial Series	C.7.3.2	Never
Equipment	General Equipment	C.7.5.1	Auto
Document	Key Object Document	C.17.6.2	Always
	SR Document Content	C.17.3	Always
	SOP Common	C.12.1	Auto

7.2 Usage of Attributes from Received IOD's

7.2.1 Core Server

No SOP Class specific fields for images are required.

7.2.2 Web Server

No SOP Class specific fields for images are required, although for best display, the following fields are recommended (this is not an exhaustive list of attributes used, but includes the ones which significantly affect display)

- Modality – used to select tools and options available

- View Code Sequence – for MG used to display/regroup by view type
- Instance Number – used for multiframe to split/group multiframe belonging to the same multiframe sequence but split into two or more objects for size reasons
- Echo Number – used to split MR series by echo
- Number of Frames – required to organize and figure out how many images are to be displayed in the client
- Window Center/Width – used to specify the initial window level
- LUTs – applied against the image to display the image with the correct appearance
- Pixel Spacing (or the related ERMF attributes), used to display true size and for measurements
- Slice Thickness – used to hide thin slice data
- Image Type – used to hide 'For Processing' images
- Echo Time – for MR is required if the series is to be split by echo time values.
- Pixel Padding – for MG if the mask is to be shown in black around the breast.

7.3 Attribute Mapping

Not applicable.

7.4 Coerced/Modified fields

7.4.1 Core Server

Attribute coercion is configurable for IOD's received by the Storage Server. Attributes can either be mapped or may be filled with "fixed values" depending on the existence or the content(s) of one or more other Attributes.

Patient Information, Patient Demographics and Study Information will be updated automatically by information received from HIS/RIS based upon corresponding patient and order information.

The coerced/modified Attribute values are provided when a remote Query/Retrieve SCU queries information or when SOP Instances are sent to a remote Storage SCP. Attribute Coercion will be indicated in the appropriate Service Response Status.

7.4.1.1 Reassignment of private elements reserved blocks

As specified by DICOM, reassigning of private element reserved blocks within a private group number is permitted as long as the Private Creator data element value (which is the unique identifier) stay the same (is not modified).

When Enterprise Imaging receives DICOM IODs containing private data elements, it may reassign the private elements reserved blocks for a given Private creator. This reassignment of reserved blocks may occur in the DICOM root and in the DICOM sequence items if there is a conflicting situation where 2 different private creators share the same attribute group number and the same elements reserved blocks.

But it can also occur in the following circumstances:

If the elements Reserved block is not the lowest available for a given private Creator, EI will reassign the reserved block to the lowest available.

For example, if the first private creator element in the dicom header is: (0031,0011)

“HappyModality Private ID”, the reserved data elements for the private creator

“HappyModality Private ID” are (0031, 1100-11FF). EI will reassign the reserved data elements to the lowest block available (1000-10FF). As a consequence the private creator data element will become: (0031,0010) “HappyModality Private ID”.

7.4.2 Web Server

No attributes are coerced/modified, except that all patient, study and series level attributes in C-Move stored objects are coerced to the values found at the time of display from a C-Find. Thus, updates to patient information will be done via the C-Find request.

7.5 Data Dictionary of Private Attributes

No private attributes are defined for the purposes of external interaction with DICOM devices. Some attributes are defined/used internally.

7.6 Coded Terminology and Templates

7.6.1 Core Server

The value for Code Meaning will be displayed for all code sequences. No local lexicon is provided to look up alternative code meanings.

7.6.2 Web Server

The value for Code Meaning will be displayed for all code sequences. A local lexicon is used based on the code value, and if present will replace the code meaning. A standard set of lexicons is provided for the supported languages.

7.7 Grayscale Image Consistency

The high resolution display monitor attached to the product can be calibrated according to the Grayscale Standard Display Function (GSDF).

All attached XERO Viewer client systems are sent data for calibrated GSDF monitors. There are options for specifying monitor calibration for a limited set of devices, including the Apple iPad 3, for a limited set of standard lighting conditions; otherwise the images are sent assuming a calibrated NEMA monitor. A calibration pattern is provided.

7.8 Standard Extended/Specialized/Private SOP Classes

Enterprise Imaging supports the following private SOP classes as SCU only:

- Dcm4che StudyRoot FIND (1.2.40.0.13.1.5.1.4.1.2.2.1)
- Dcm4che Blocked StudyRoot FIND (1.2.40.0.13.1.5.1.4.1.2.2.1.1)

7.9 Private Transfer Syntaxes

None.